

MANUALIDADES & ACCESORIOS

CRAFTS & ACCESSORIES

LOISIRS CREATIFS

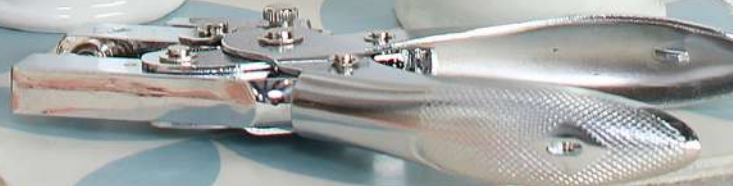



misskuty.

MÁQUINAS Y COMPLEMENTOS

MACHINES AND ACCESSORIES

MACHINES ET COMPLÉMENTS

A las máquinas MISSKUTY son ligeras y versátiles, fáciles de utilizar, almacenar y transportar. Junto con los troqueles Zag i Zug o las carpetas Push, podrás cortar y repujar una gran variedad de materiales.

MISSKUTY machines are light and versatile, easy to use, store and transport. Together with Zag and Zug dies or Push Folders, you can cut and emboss a wide variety of materials.

Les machines MISSKUTY sont légères et polyvalentes, faciles à utiliser, à stocker et à transporter. Avec les matrices Zag et Zug ou les dossier de gaufrage, vous pouvez découper et gaufrer une grande variété de matériaux.



MÁQUINAS MISSKUTY · MACHINES MISSKUTY · MACHINES MISSKUTY



41040-M



41040-L



15cm



22,5cm



Contiene una máquina MISSKUTY, una plataforma, una base de corte, un adaptador para troqueles gruesos e instrucciones de uso.

It includes an MISSKUTY, a Platform, a Cutting Plate, an Adapter for Thick Dies and Instruction Brochure.

Contient une machine MISSKUTY, une plateforme, une base de découpe, un adaptateur pour matrices de découpe épaisses et instructions d'utilisation.



Botón micro ajuste
Ajusta la presión entre los dos rodillos y consigue los mejores resultados. ¡Sin necesidad de accesorios adicionales!

Micro-adjustment Switch
It adjusts the pressure of the two rollers to get the best results.
No need of additional accessories!

Bouton micro ajustement
Ajuste la pression entre les deux rouleaux et réussit les meilleurs résultats.
Aucun besoin d'accessoires supplémentaires !

Botón funciones
Escoge una función girando el botón. ¿Te apetece troquelar, repujar en 2D o repujar en 3D?

Function Switch
Select a function by turning the switch. Do you feel like cutting, 2D embossing or 3D embossing?

Bouton fonctions
Choisissez une fonction en tournant le bouton.
Vous avez envie de perforez, gaufrer en 2D ou gaufrer en 3D ?

Plataforma abatible
Al abrir la plataforma, la máquina se adhiere a la superficie gracias a las ventosas situadas en la base. Utiliza el compartimento para almacenar la manivela y pequeños accesorios.

Fold-out Platform
Once the platform is open, the machine adheres firmly to any sturdy and flat surface thanks to suction cups placed on the base. Use the compartment to store the crank handle and small accessories.

Plateforme abattable
En ouvrant la plateforme, la machine s'adhere à la surface grâce aux ventouses situées à la base. Utilisez le compartiment pour emmagasiner la manivelle et les petits accessoires.

FOLLETO

- FLYER
- PROSPECTUS



MK002-ES

MK002-FR

Fabricados en acero altamente resistente, permiten cortar papel, cartulina, goma eva y hojas de aluminio.

*También compatibles con máquinas para troquelar de otras marcas.

Made of high resistant steel, they are suitable to cut paper, cardstock, Eva foam and aluminium sheets.

*Compatible with MISSKUTY Cutting & Embossing Machines and die cutting machines from other brands.

Fabriquées en acier hautement résistantes, elles nous permettent pouvoir couper du papier, bristol, mousse eva et feuilles d'aluminium.

*Compatibles avec les machines pour perforer et gauffer MISSKUTY et autres marques.



Troquel fino
Thin Die
Matrice de découpe fine



41010

7,8x7,8cm. 🗑️ 2



41011

6,2x7,3cm. 🗑️ 2

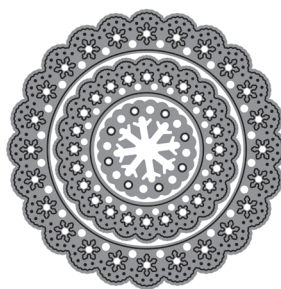

41014

∅ 10,5x10,5cm. 🗑️ 1

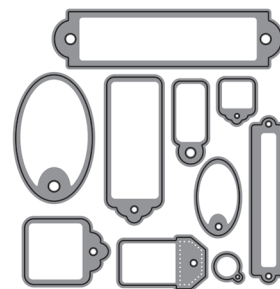

41015

11x11,3cm. 🗑️ 1

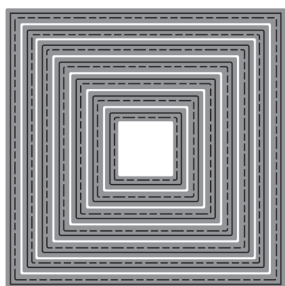

41012

7,4x7,4cm. 🗑️ 2



41013

∅ 7,4cm. 🗑️ 2

Troqueles aptos para cortar y repujar
Para repujar es imprescindible utilizar la alfombrilla de silicona (ref. 41009).

Dies for Cutting and Embossing
Use Silicone Rubber Pad for embossing (item 41009).

Matrices de découpe aptes pour couper et gauffer
Pour gauffer il est nécessaire d'utiliser le petit tapis de silicone (réf. 41009).





Los troqueles ZUG son cuchillas de acero integradas en planchas de 1,6cm de grosor. Permiten cortar una gran variedad de materiales de hasta 4mm de grosor: papel, cartulina, goma eva, cuero, fieltro, imán, corcho, madera de balsa, tela y más.

*También compatibles con máquinas para troquelar de otras marcas.

ZUG dies are steel blades built into 1.6 cm thick plates. They are suitable to cut a large variety of materials up to 4 mm thickness: paper, cardstock, Eva foam, leather, felt, magnetic plates, cork, balsa wood, fabric and more.

*Compatible with MISSKUTY Cutting & Embossing Machines and die cutting machines from other brands.

Les matrices de découpe ZUG sont des lames en acier intégrées en planches de 1,6cm d'épaisseur. Elles permettent pouvoir couper une grande variété de matériaux jusqu'à 4mm d'épaisseur : papier, bristol, gomme eva, cuir, feutre, aimant, liège, bois de radeau, tissu et plus.

*Compatibles avec les machines pour découper et gaufrir MISSKUTY et autres marques.



Troquel grueso
Thick Die
Matrice de découpe épaisse

1
14x15,2cm.



- 1
- 2
- 3

Adaptador
Adapter
Adaptateur

Troquel grueso
Thick Die
Matrice decoupe épaisse

Papel
Paper
Papier

Base de corte
Cutting Mat
Base de découpe

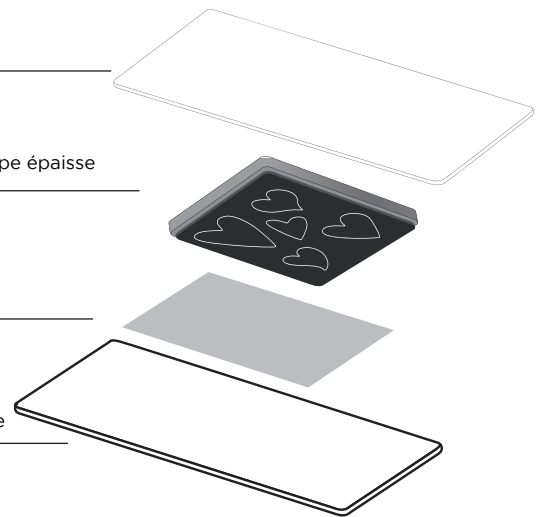

Las bases para las máquinas MISSKUTY se utilizan junto con los troqueles finos ZAG, los troqueles gruesos ZUG, las carpetas de repujado PUSH, placas tipográficas y troqueles y placas textura de otras marcas. Están fabricadas en PVC de alta calidad y, a diferencia de otras marcas, se utiliza con las MISSKUTY tanto para los troqueles finos, como los troqueles gruesos y las carpetas de repujado. La alfombrilla de silicona se utiliza junto con los troqueles finos ZUG aptos para repujar o placas textura para conseguir efecto relieve.

Cutting Mats for MISSKUTY machines are used with ZAG Thin Dies, ZUG Thick Dies, PUSH Embossing Folders, Letterpress Plates and dies and texture plates from other brands. They are made of high quality PVC and, unlike other brands; they are used with MISSKUTY machines for thin dies, thick dies and embossing folders. Silicone Rubber Pad is used with the ZAG Thin Dies which are suitable for embossing or texture plates to get relief effect.

Les bases pour les machines MISSKUTY sont utilisées avec les matrices de découpe fines ZAG, les matrices de découpe épaisses ZUG, les dossiers de gaufrage PUSH, plaques typographiques et matrices de découpe et plaques de texture d'autres marques. Elles sont fabriquées en PVC haute qualité, et à différence d'autres marques, elles sont utilisées avec les MISSKUTY aussi bien pour les matrices de découpe fines, comme pour les matrices de découpe épaisses et les dossiers de gaufrage. Le petit tapis en silicone s'utilise avec les matrices de découpe fines ZAG aptes pour gaufrer ou plaques de texture pour réussir un effet relief.



Base de corte
Cutting mat
Base de découpe

🗑️ 1



41007

Base de corte
Cutting Mat
Base de découpe
🗑️ 15x33x0,3cm.



41008

Base de corte
Cutting Mat
Base de découpe
🗑️ 22,5x33,0,3cm.



41050

Base de corte transparente
Transparent cutting mat
Base de découpe transparent
🗑️ 15x22x0,3cm.

Plataforma
Platform
Plate-forme

Troquel fino
ZAG Thin Die
Matrice de découpe fine

Papel
Paper
Papier

Base de corte
Cutting Mat
Base de découpe

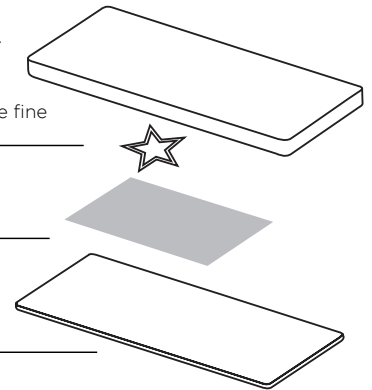

41009

Alfombrilla para repujar
Silicone Rubber Pad
Petit tapis pour gaufrer
🗑️ 15,3x21,6x0,2cm.

Base de corte
Cutting Mat
Base de découpe

Alfombrilla para repujar
Silicone Rubber Pad
Petit tapis pour gaufrer

Papel
Paper
Papier

Troquel
Die
Matrice de découpe

Plataforma
Platform
Plate-forme

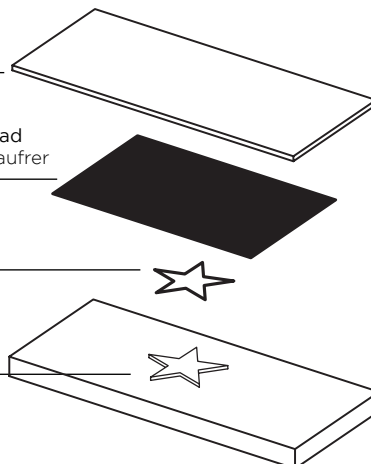



Las carpetas de repujado PUSH permiten crear textura sobre un simple papel, cartulina, goma eva u hoja de aluminio, convirtiendo cualquier proyecto en una pequeña obra de arte. ¡Resaltar tus trabajos nunca había sido tan fácil!

*Compatibles con las máquinas para troquelar y repujar MISSKUTY y otras marcas.

With PUSH Embossing Folders you can create texture effects on ordinary paper, cardstock, Eva foam or aluminium sheets, and turn any project into a small masterpiece. Highlighting your works has never been so easy!

*Compatible with MISSKUTY Cutting & Embossing Machines and die cutting machines from other brands.

Les dossiers de gaufrage PUSH permettent de pouvoir créer une texture sur un simple papier, bristol, mousse eva ou feuille d'aluminium, transformant tout projet en une petite œuvre d'art. Mettre en valeur vos résultats de travail n'aura jamais été si facile !

*Compatibles avec les machines pour découper et gaufrer MISSKUTY et autres marques.



Carpeta de repujado
Embossing folder
Dossier de gaufrage

2
12,7x17,8cm.

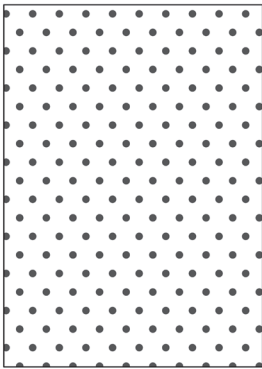

41016

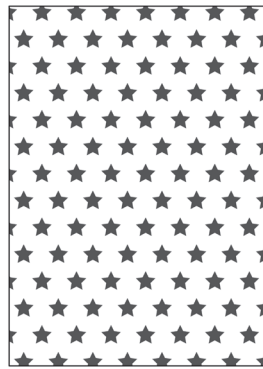

41017

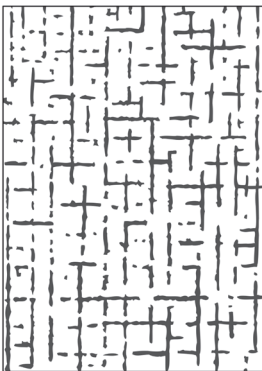

41018



41019

Base de corte
Cutting Mat
Base de découpe

Carpeta de repujado
Embossing folder
Dossier de gaufrage

Papel
Paper
Papier

Plataforma
Platform
Plate-forme

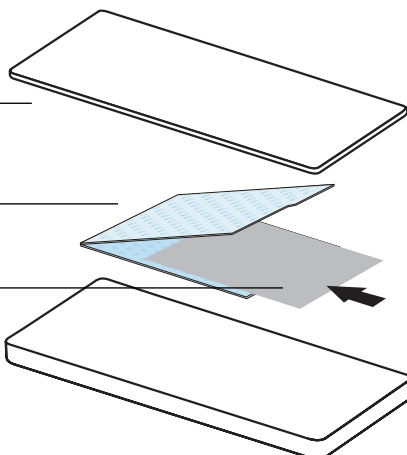

TROQUELES GRUESOS · BIG DIES · MATRICES DE DÉCOUPE ÉPAISSEUR

🛒 1



E657012 E657013 E657015 E657017 E657019

E657022 E657024 E657026 E657027

TROQUELES INFANTILES · CHILDREN'S DIES · MATRICES DE DÉCOUPE POUR ENFANTS

🛒 1



EA10105 EA10113 EA10128 EA10153 EA10184

EA10336 EA10664 EA10665 EA10666 EA10696

TROQUELES THINLITS · DIES THINLITS · MATRICES DE DÉCOUPE THINLITS

🛒 1



E659747 E659756 E659757 E659973



TROQUELES MAGNÉTICOS · MAGNETIC DIES · MATRICES DE DÉCOUPE MAGNÉTIQUE

1



E656427

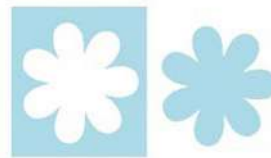

E656442



E656443



E656444

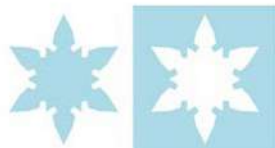

E656447



E656453

CARPETAS REPUJADO 2D · 2D FOLDERS · DOSSIERS DE GAUFRAGE 2D

1



E655841



E655842



E656262



E656352



E656469



E656501



E656503



E656584



E656585



E656776



E656777



E656798

TROQUELADORAS MAGNÉTICAS ANYWHERE PUNCH

MAGNETIC ANYWHERE PUNCHES

PERFORATRICES MAGNÉTIQUES ANYWHERE



80-180 gr/m²
1

Troquele formas decorativas perfectas en cualquier lugar de la página, incluso en el centro, simplemente colocando el papel entre las dos partes de la troqueladora y presionar. Para crear tarjetas únicas con ventanas, mini marcos para fotos, etiquetas personalizadas y mucho más.

Punch perfect decorative shapes anywhere all over the page, even the center. Simply position your paper between top and base, then punch! Create unique window cards, mini photo mats, custom tags, and more.

Perfore des formes décoratives parfaits n'importe où dans la page, même au centre. Placez simplement votre papier entre les deux parties, et poussez le sommet! Créer des cartes uniques avec fenêtre, mini passe-partout pour photos, des étiquettes personnalisées et plus.

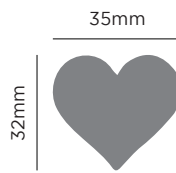

39001

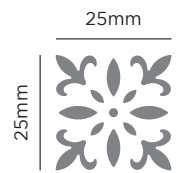

39002

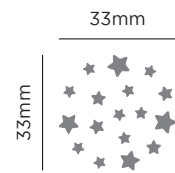

39003

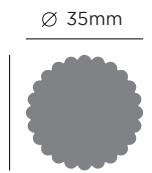

39004



continuo-continuos-continuo



39005

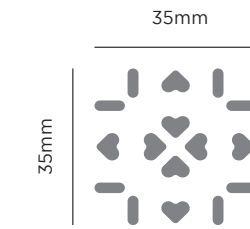

39006

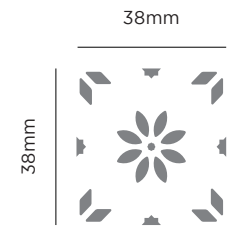

39007

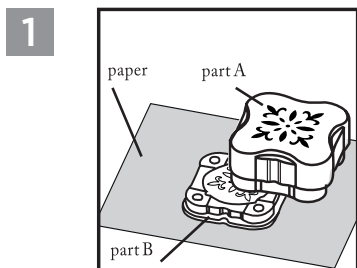

1 Colocar el papel entre la parte A y la parte B.

Position your paper between part A and part B.

Mettre le papier entre la partie A et la partie B.

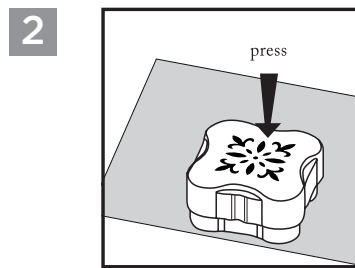

2 Presionar la parte A asegurándose que los imanes de la parte A y la parte B coincidan.

Press part A making sure the magnets in part A and part B match.

Poussez la partie A en vous assurant que les aimants de la partie A et la partie B coincident.

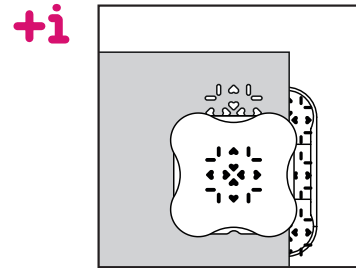

+i Usar la guía de alineación sobre la base para conseguir un diseño continuo.

Use the alignment guide on the base to have continuous design.

Utilisez la guide d'alignement de la base afin d'obtenir un motif continu.



TROQUELADORAS BORDES CONTINUO

CONTINUOUS BORDER PUNCHES

PERFORATRICES BORDURE CONTINUE



120-200 gr/m²
1

Permiten crear bordes continuos en tarjetas, páginas de libro, regalos... Las guías de alineación ayudan a crear un diseño continuo. Es posible perforar el diseño alrededor de toda la página.

With these border punch you can create a continuous die-cut border. Add a pretty edge on cards, scrapbook pages and gifts. Alignment guides help create a continuous pattern. All around page design is available.

Permetten de créer une bordure continue. Ajoutez un joli bordure sur les cartes, les pages de scrapbook et les cadeaux. Les guides d'alignement permettent de créer un modèle continu. Tout le design de la page est disponible.

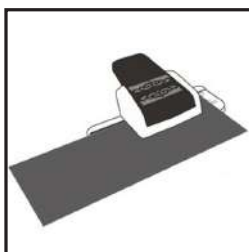
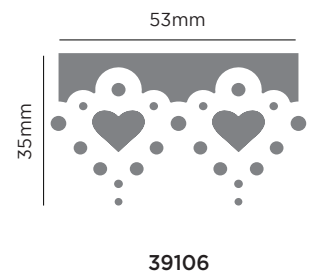
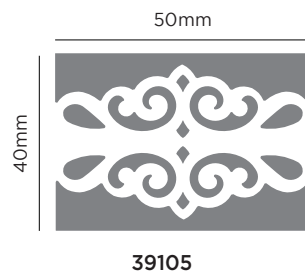
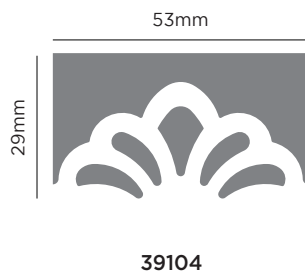
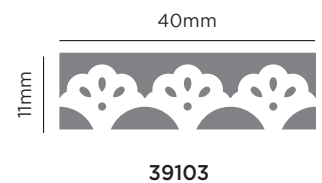
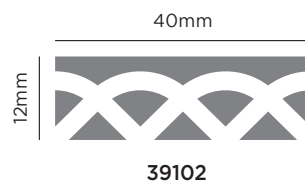
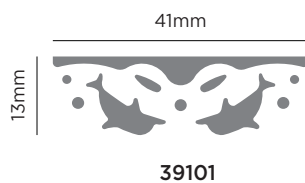

Insertar el papel y perforar.
Insert the paper and punch.
Mettre le papier et perforer.

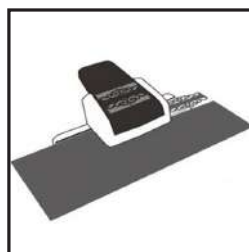

Para realizar bordes continuos ajustar el diseño perforado en la guía de alineación y volver a perforar.

For continuous borders, slide the paper until the punched pattern lines up with the printed pattern on the alignment guide and punch again.

Pour réaliser des bordures continues, ajuster le motif imprimé de la guide d'alignement et perforer à nouveau.

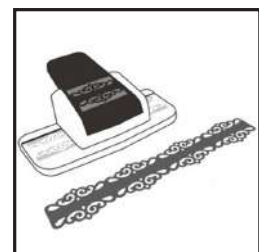

Diseño acabado.
Final look.
Motif fini.



SET TROQUELADORA BORDE CONTINUO INTERCAMBIABLE

INTERCHANGEABLE CONTINUOUS BORDER PUNCH SET

SET PERFORATRICE BORDURE CONTINUE INTERCHANGEABLE



120-160
gr/m²
1

Perforadora especial para un diseño continuo alrededor de los cuatro lados de una página. Para troquelar complicados diseños de bordes en tarjetas, páginas de scrapbooking y otros trabajos de papel. Divertido y fácil de usar.

Special punch for continuous design around all four sides of a page. Let you punch intricate die-cut border designs on cards, scrapbook pages and other paper crafts. Fun and easy to use.

Perforatrice special pour créer un dessin continue autour des quatre côtés d'une feuille. Permet de perorer des motifs de bordure complexes sur des cartes, des pages de scrapbook et d'autres travaux d'artisanat. Fun et facile à utiliser.

1



39200

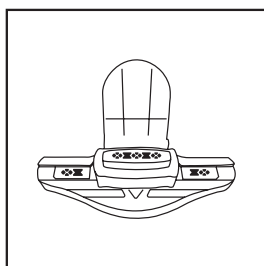
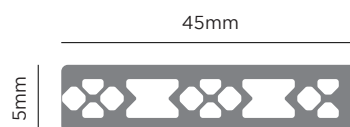

Colocar el cartucho en la base y las dos piezas con el diseño (incluidas en el set) en la guía de alineación.

Put the cartridge on the base and the two small pieces with the printed design (included in the set) on the alignment guide.

Mettez la cartouche sur la base et les deux petits morceaux avec la conception imprimée (inclus dans le set) sur le guide d'alignement.

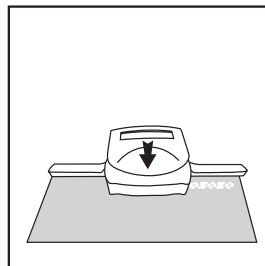

Insertar el papel y perforar.

Insert the paper and punch.

Insérez le papier et perforez.

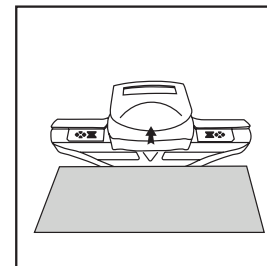

Para bordes continuos, mover el papel hasta ajustar el diseño perforado con la guía de alineación y volver a perforar.

For continuous borders, slide the paper until the punched pattern lines up with the printed pattern on the alignment guide and punch again.

Pour les bordures continues, faire glisser le papier jusqu'à ce que le motif perforé s'élève avec le motif imprimé sur le guide d'alignement et perforez à nouveau.

Cartucho para utilizar con la troqueladora de borde continuo intercambiable. Los cartuchos resultan fáciles de transportar y almacenar.

Las piezas con los diseños para colocar en la guía de alineación de la base se pueden almacenar dentro del protector del cartucho.

Cartridge to use with the Interchangeable continuous border punch. Cartridges are easy, transportable and stockable.

The pieces with printed design for the alignment guide on the base can be stored inside the cartridge protector.

Cartouche à utiliser avec la perforatrice de bordure continue interchangeable. Les cartouches sont faciles à transporter et stocker. Les pièces avec les dessins pour placer en la guide d'alignement sur la base peuvent être stockées dans le protecteur du cartouche.



1

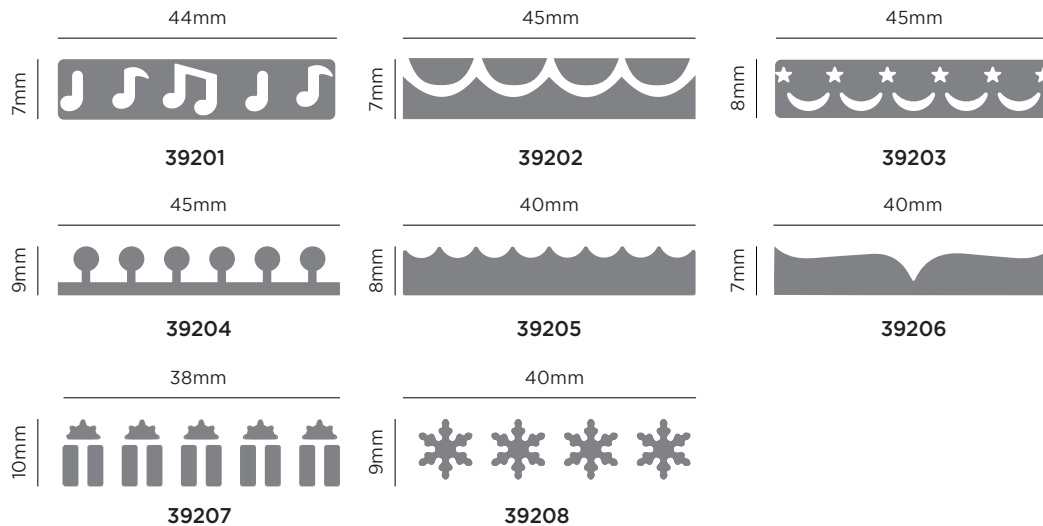

INSTRUCCIONES MONTAJE · ASSEMBLY INSTRUCTIONS · INSTRUCTIONS DE MONTAGE

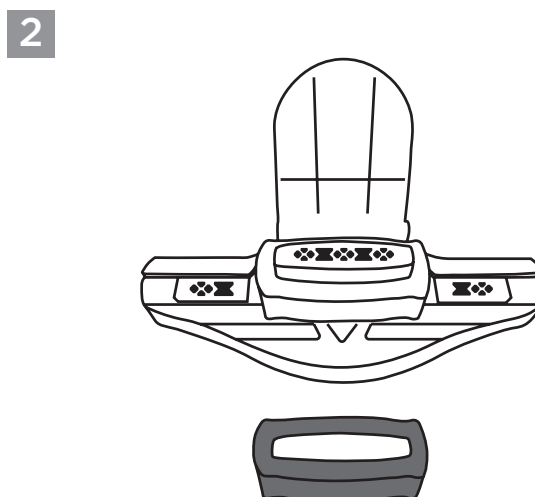
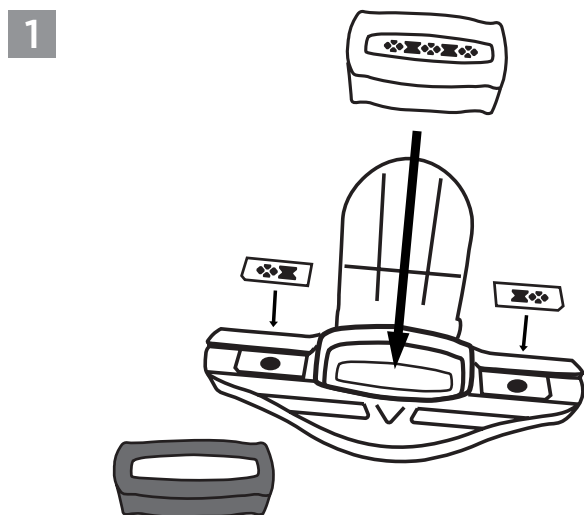

TROQUELADORAS FIGURAS GOMA EVA

EVA FOAM PUNCHES

PERFORATRICES MOUSSE EVA



120-200
gr/m²

Troqueladora para crear formas fácilmente. Perfora sin esfuerzo goma EVA de hasta 2mm, papel de entre 120-200gr y cartulina. Incluye un depósito en la base que permite guardar las formas perforadas para poder utilizarlas como decoración.

Easy-to-use shape punch. Punch out EVA foam up to 2mm, 120-200g paper and cardstock. Built-in confetti catcher allows to store all punchouts in order to use them as decorations.

Perforatrice pour créer des formes facilement. Perfore mousse EVA de jusqu'à 2mm, papier de 120-200g et papier cartonné. Le collecteur de confettilles intégré permet de stocker tous les punchouts afin de les utiliser comme décorations.



TROQUELADORAS FIGURAS GOMA EVA · EVA FOAM PUNCHES · PERFORATRICES MOUSSE EVA

16mm

2

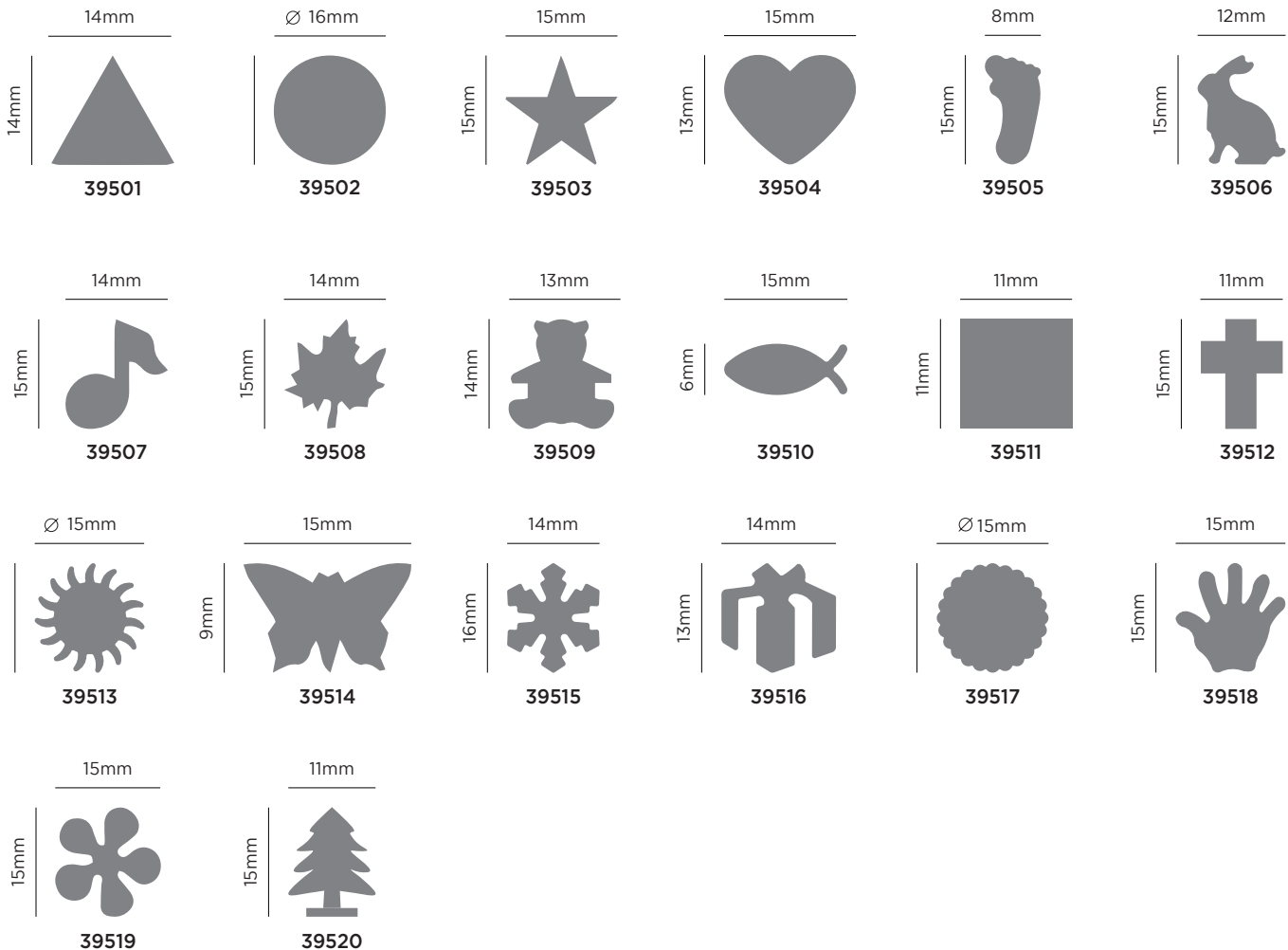



TROQUELADORAS FIGURAS GOMA EVA · EVA FOAM PUNCHES · PERFORATRICES MOUSSE EVA

25mm

2

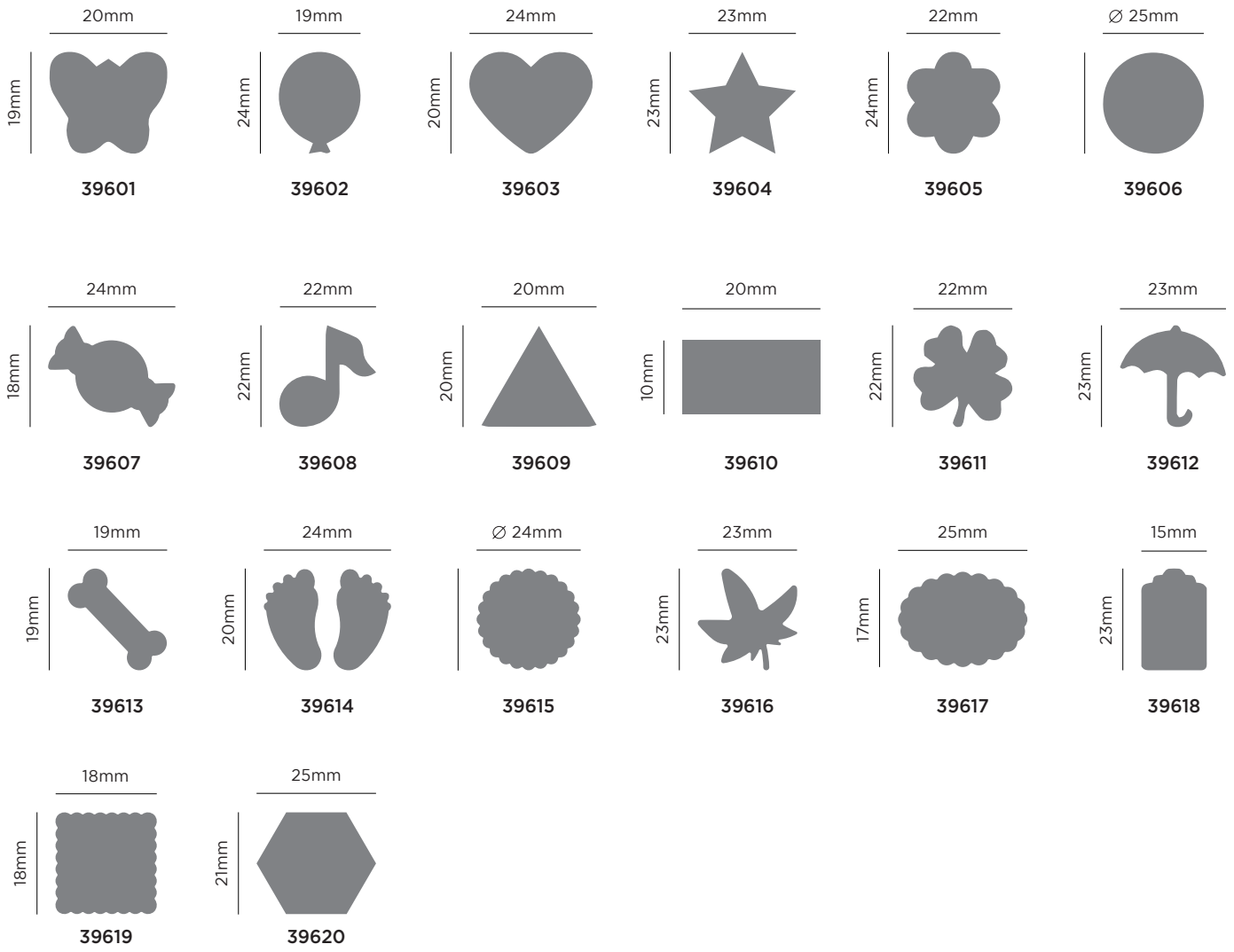

TROQUELADORAS FIGURAS GOMA EVA · EVA FOAM PUNCHES · PERFORATRICES MOUSSE EVA

38mm

1

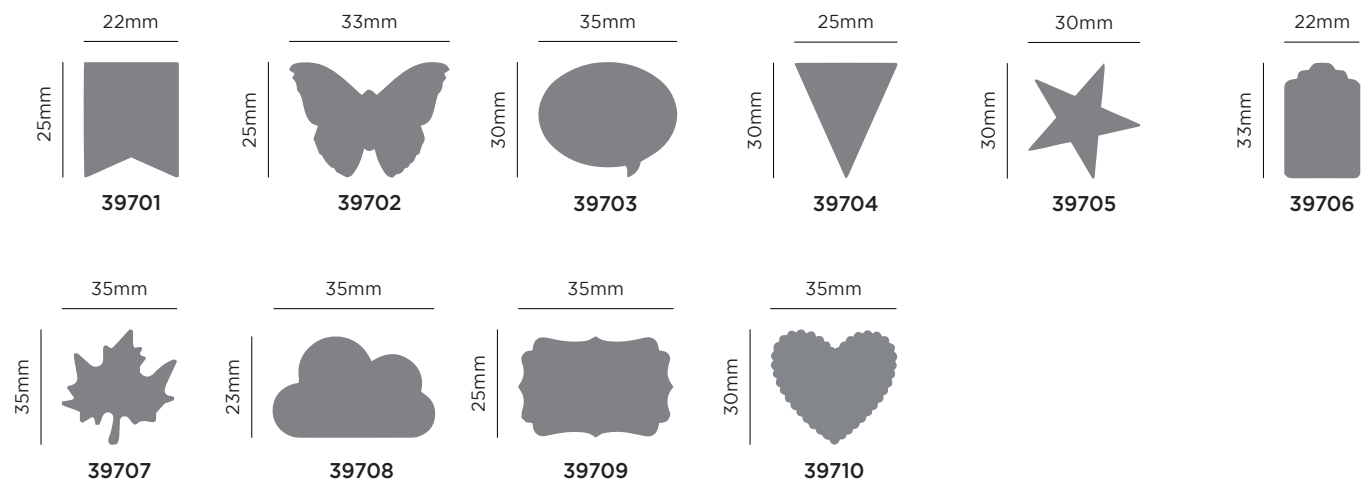



TROQUELADORAS FIGURAS GOMA EVA · EVA FOAM PUNCHES · PERFORATRICES MOUSSE EVA

50mm

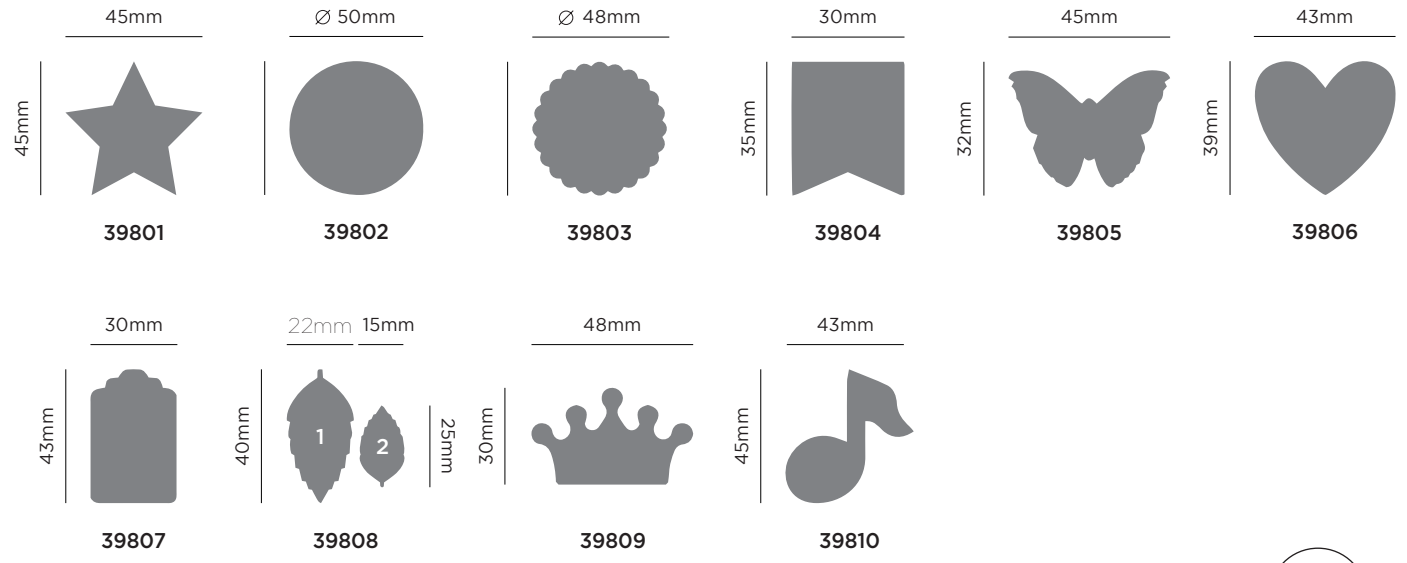

TROQUELADORAS FIGURAS GOMA EVA · EVA FOAM PUNCHES · PERFORATRICES MOUSSE EVA

76mm

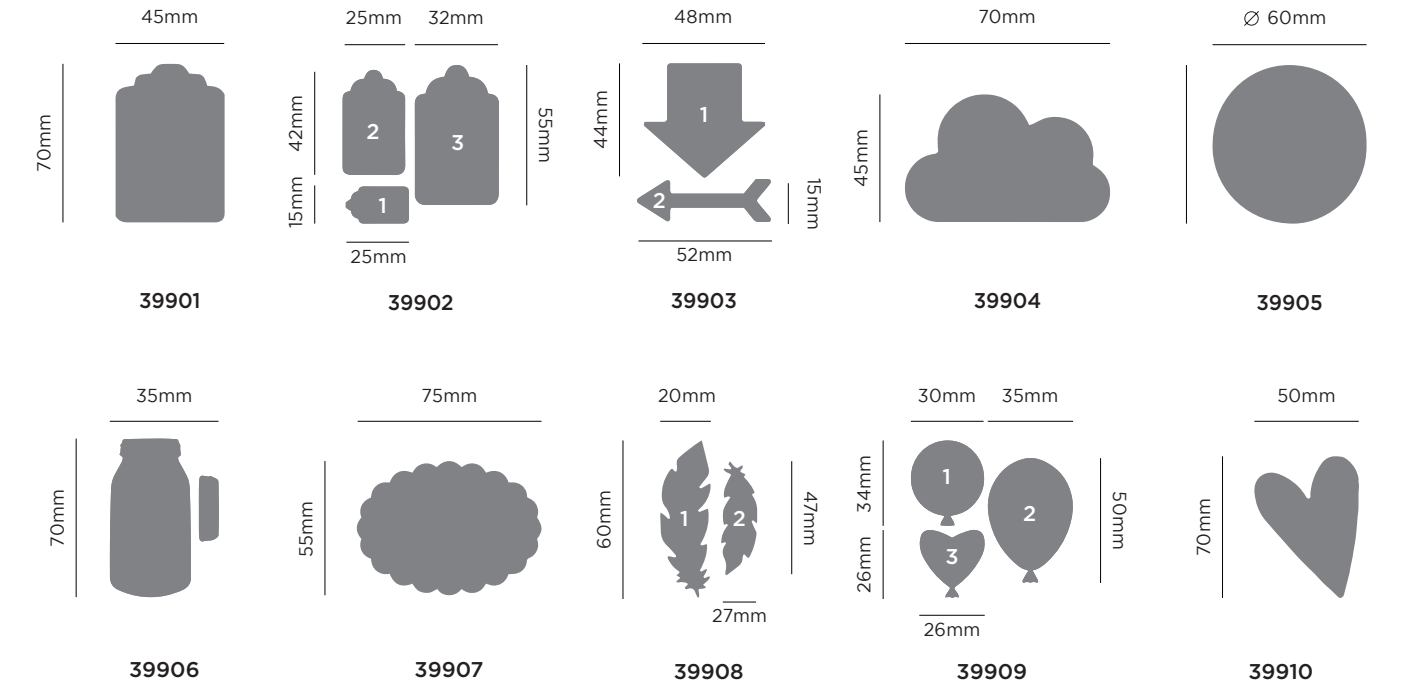



TROQUELADORAS 3-D POP UP

3-D POP UP PUNCHES

PERFORATRICES 3-D POP UP



120-180 gr/m²

Troqueladora para crear formas con efecto 3D fácilmente. Incluye un depósito en la base que permite guardar los restos de papel para poder utilizarlos como confeti.

Easy-to-use 3D shape punch. Built-in confetti catcher allows to store all paper remainders.

Perforatrice pour créer des formes avec effet 3D. Inclus un dépôt sur la base qui permet de pouvoir garder les restes de papier afin de pouvoir les utiliser comme des confettis.

1

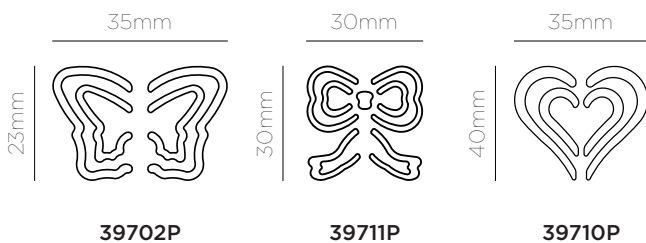
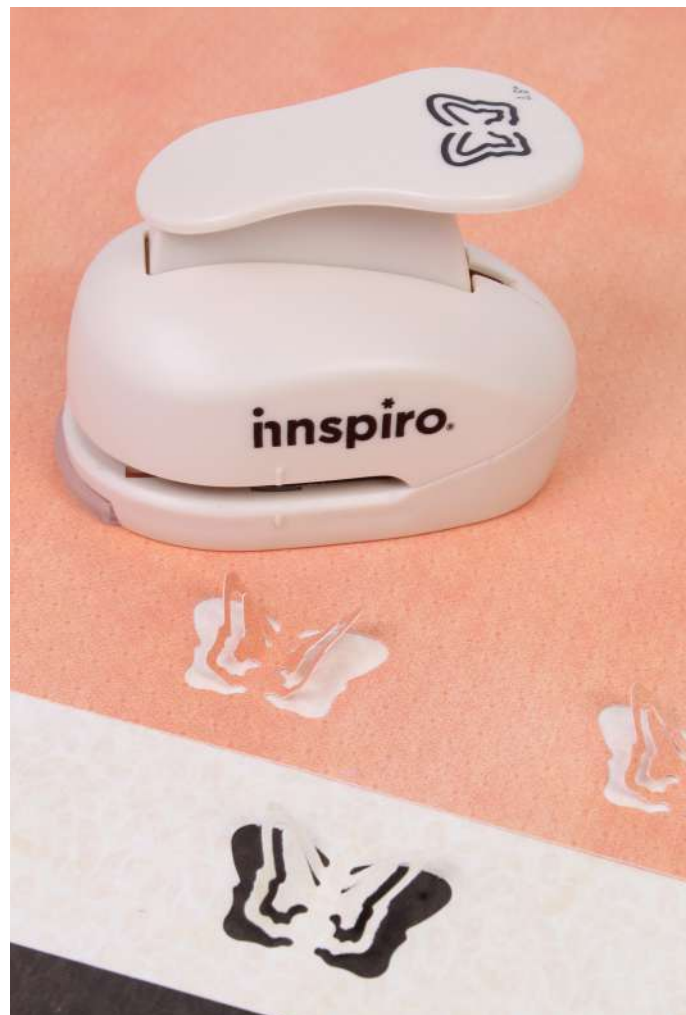

TROQUELADORA LLAVERO · KEY-RING PUNCH · MINI PERFORATRICE PORTE CLÉS

4



Ø 8mm



120-160 gr/m²

39999



TROQUELADORAS ESQUINAS DECORATIVAS

DECORATIVE CORNER PUNCHES

PERFORATRICES DE COIN DECORÉES



120-180 gr/m²

Troqueladora para decorar esquinas fácilmente. Incluye un depósito en la base que permite guardar los restos de papel para poder utilizarlo como confeti.

Easy-to-use punch for decorating corners. Built-in confetti catcher allows to store all paper remainders.

Perforatrice pour décorer des coins facilement. Inclus un dépôt sur la base qui permet de pouvoir garder les restes de papier afin de pouvoir l'utiliser comme confettis.

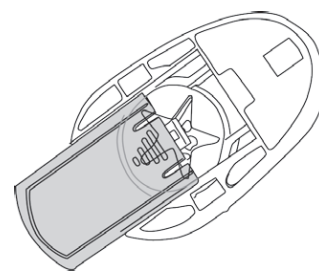
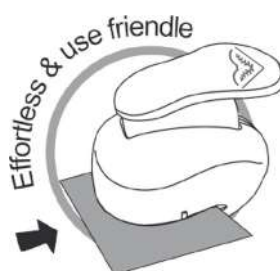

TROQUELADORAS ESQUINAS · CORNER PUNCHES · PERFORATRICES DE COIN

25mm

2

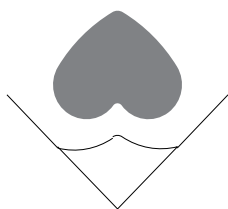

39301

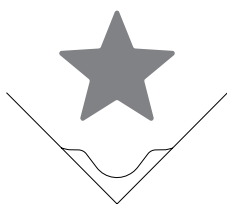

39302

TROQUELADORAS ESQUINAS · CORNER PUNCHES · PERFORATRICES DE COIN

38mm

1



39304



39303



TROQUELADORAS ESQUINAS 3 EN 1

3 IN 1 CORNER PUNCH

PERFORATRICES DE COIN 3 EN 1



120-180 gr/m²
1

Troqueladora para redondear esquinas fácilmente. Permite realizar tres medidas de esquinas diferentes. Perfora sin esfuerzo materiales como goma eva de hasta 2mm, papel de hasta 180gr y fotografías.

Easy-to-use corner rounding punch. Create three different sizes of corners. Punch with no effort materials like Eva foam up to 2mm, paper up to 180g and photos.

Punch pour arrondir facilement les coins. Il permet trois mesures de différents angles. Perfore sans effort des matériaux comme gomme eva jusqu'à 2mm, papier jusqu'à 180g et des photographies.

2



39300

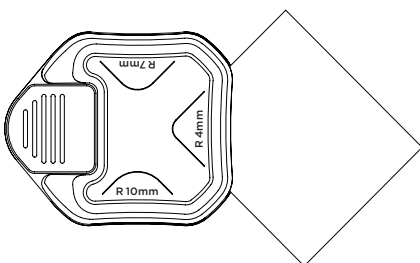
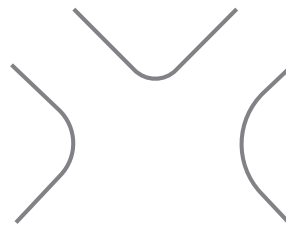

R • 4mm

Troquelar esquina pequeña con R4.

Cut small corner with R4 punch.

Couper un petit coin avec un punch R4.

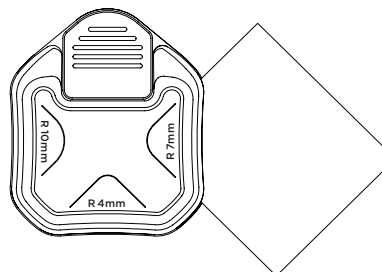

R • 7mm

Troquelar esquina mediana con R7.

Cut medium corner with R7 punch.

Couper un medium coin avec un punch R7.

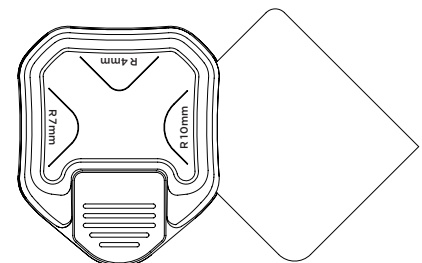

R • 10mm

Troquelar esquina grande con R10.

Cut large corner with R10 punch.

Couper un grand coin avec un punch R10.



TROQUELADORAS CASSETTE PUNCH SET

PUNCHES CASSETTE PUNCH SET

PERFORATRICES CASSETTE PUNCH SET



120-200
gr/m²
1

Troqueladora para crear diferentes formas fácilmente. Incluye 4 cartuchos con distintos diseños.

Easy-to-use shape punch. It includes 4 cassettes of different designs.

Perforatrice pour créer différentes formes facilement. Inclus 4 cartouches de différents modèles.



Aprox. 16mm

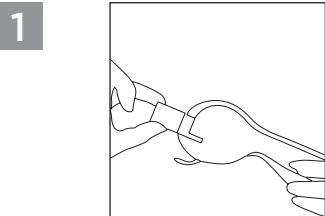
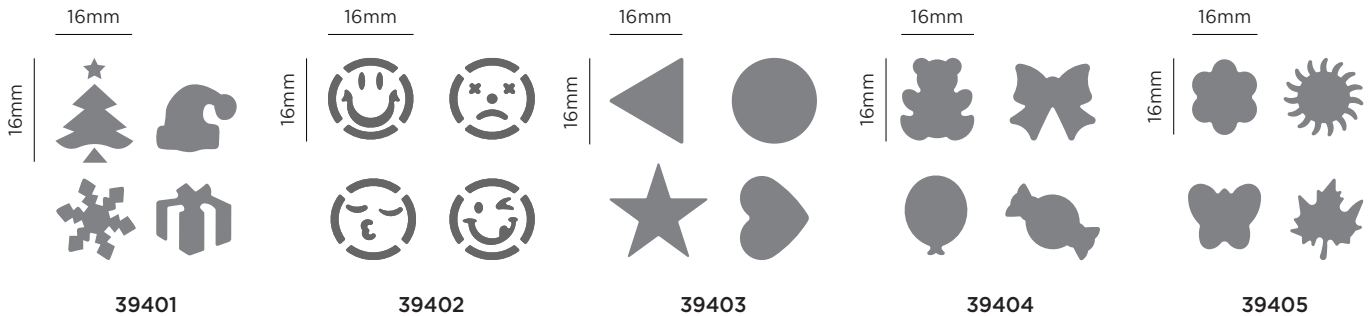

1 **Introducir el cartucho.**
— Insert a cassette.
— Introduire la cartouche.

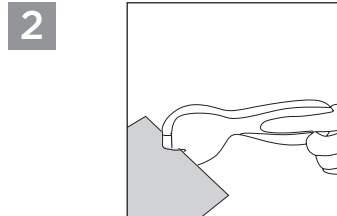

2 **Insertar el papel y perforar.**
— Put the paper in and punch.
— Introduire le papier et perforer.

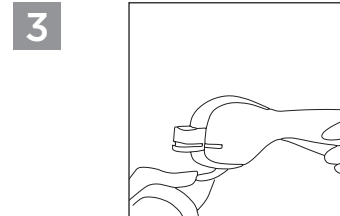

3 **Para quitar el cartucho, abrir la tapa situada en la parte inferior del punch.**
— To eject cassette, pull down on flap.
— Pour enlever la cartouche, ouvrir le couvercle du dépôt de confetti situé sur la partie inférieure du punch.



TROQUELADORAS ETIQUETAS

TAG PUNCH

PERFORATRICE ÉTIQUETTES



150-250 gr/m²
1

Troqueladora para crear etiquetas o banderolas. Corta la etiqueta y perfora el agujero creando un efecto relieve. Posibilidad de realizar tres etiquetas de distintas medidas.

Tag Maker Punch out a tag and make a hole with an embossed effect. Possibility to make three different tags.

Perforatrice pour créer des étiquettes. Couper l'étiquette et perforer le trou en créant un effet relief. Possibilité de réaliser trois étiquettes différentes.

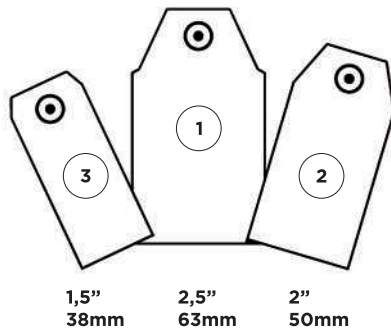

40000

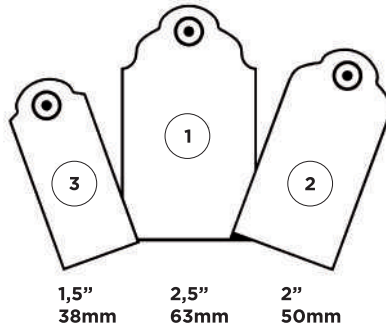

40001

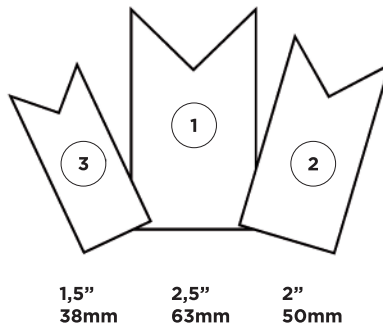

40002



Insertar una hoja de 63mm, de 50mm o de 38mm de ancho en función del tipo de etiqueta o banderola que se quiera crear.

Insert 63mm (2.5"), 50mm (2"), or 38mm (1.5") wide paper, depending on the type of tag desired.

Mettre une feuille de 63mm, de 50mm ou de 38mm de large en fonction du type d'étiquette que vous souhaitez créer.



TROQUELADORAS DE BLONDAS

—
BLOND TAG

—
PERFORATRICES DOILIES



150-250
gr/m²
1

Troquel especial para papel de 6" (15,24cm), siga los pasos a continuación para obtener un corte perfecto.

—
This punch is special for 6" (15,24cm), please follow steps as below to have a perfect cut out.

—
Ce perforatrice est spécial pour le papier 6" (15,24cm), veuillez suivre les étapes cidessous pour avoir une découpe parfaite.



40003



40004

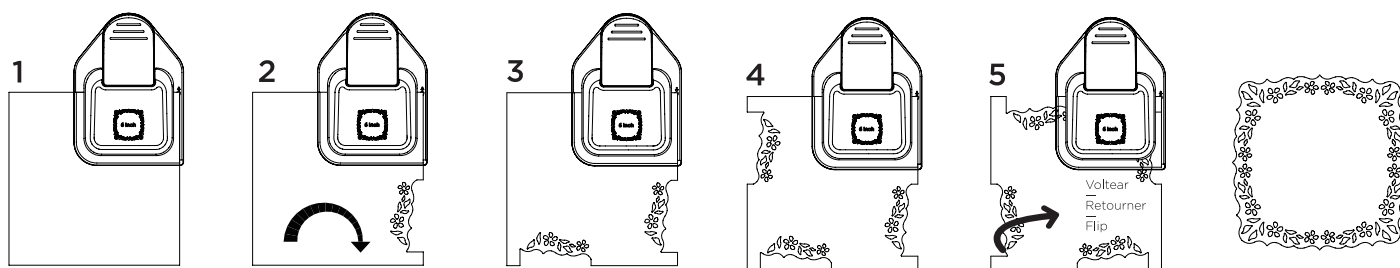



HERRAMIENTAS

TOOLS

OUTILS

CIZALLAS · PAPER TRIMMERS · CISAILLES

Cuadrícula de medición en centímetros y pulgadas. La guía transparente asegura una colocación perfecta del papel y una gran precisión a la hora de cortar o marcar.

Permanent Grid printed on the base in dual measurements: Inch and Metric. Transparent Guide for perfect paper placement and a great cutting and scoring precision.

Grille de mesure en centimètres et pouces imprimée de façon permanente sur la base. La guide transparente assure une mise en place parfaite du papier et une grande précision au moment de couper ou marquer.

1



41000
8x30cm - 35x30cm
corte
cutting
coupe



41001
11x30cm - 39x30cm
corte y marca
cutting and blade
coupe et marque



41002
15x30cm - 49x30cm
corte y marca
cutting and blade
coupe et marque

CUCHILLAS · BLADES · LAMES

6

2x Cuchillas de corte recto
Straight cutting blades
Lames de coupe droite



41003

1x Cuchilla de corte recto
Straight cutting Blade
Lame de coupe droite

1x Cuchilla para marcar
Scoring blade
Lame pour marquer



41004

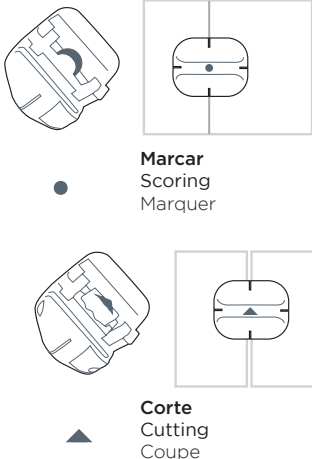

BASE PARA CREAR TARJETAS Y SOBRES · CARDS, ENVELOPES AND BOXES MAKING BOARD ·
BASE POUR CRÉER CARTES, ENVELOPPES ET BOITES

Permite crear todo tipo de tarjetas y sobres de hasta 13x18cm (tamaño de la base: 16,2x21,5cm). Instrucciones y tabla de medidas impresas en el reverso de la base.

To create all type of cards and envelopes up to 13x18cm. Base size: 16.2 x 21.5cm. Instructions and measurement chart printed on the back of the board.

Permet pouvoir créer tout type de cartes et enveloppes jusqu'à 13x18cm (taille de la base ; 16,2x21, 5cm). Instructions et table de mesure imprimées au revers de la base.



41037



PERFORADORA DE MUESCAS Y ESQUINAS · CORNER AND NOTCH PUNCH · PERFORATRICE D'ENCOCHES ET COINS

Perforadora con dos ranuras: una para redondear esquinas y la otra para crear muescas. Ideal para crear sobres y cajas, junto con las bases para sobres y cajas de Innspiro (referencias 41037 y 41039).

Two slot punch: to create round corners and to make notches. Great for making envelopes and boxes with Innspiro Envelopes and Boxes Making Board (items 41037 and 41039).

Perforatrice avec deux rainures : une pour arrondir les coins et l'autre pour créer des encoches. Parfaite pour créer des enveloppes et boites, avec les bases pour enveloppes et boites Innspiro (références 41037 et 41039).



41038

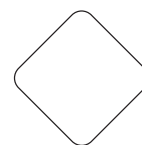

Esquinas
 Corner
 Coins

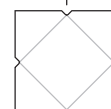

Muestras
 Notches
 Encoches

GRAPADORA MAGNÉTICA · MAGNETIC STAPLER · AGRAFEUSE MAGNÉTIQUE

Permite grapar fácilmente en cualquier parte del papel; incluye 1000 grapas.

You can staple anywhere on the page easily; included 1000 staples.

Permet pouvoiragrafer facilement sur toute partie du papier; inclut 1000 agrafes.



41005
🛒 2



PISTOLA DE CALOR · HEAT GUN · PISTOLET À CHALEUR



+i
max. 200°C
230V
300W

41031
🛒 1

Emboss · Emboss · Emboss



Plástico mágico · Shrink Plastic · Plastique fou (dingue)



Secaje y fijación de pintura · Paint drying and fixing · Séchage et fixation de peinture





PERFORADORA MANUAL
HAND PUNCH
PERFORATRICE MANUELLE

Ideal para crear confeti o realizar adornos. Perfora papel, piel i goma EVA.

It is perfect to make confetti or embellishments. To punch paper, leather and EVA foam.

Parfaite pour créer des confettis ou réaliser des ornements. Perfore le papier, cuir et mousse EVA.

0,64mm

1



41030

REMACHADORA · RIVETER · RIVETEUSE

Herramienta para perforar y colocar ojales. Perfora papel, PVC de hasta 2mm de grosor, plástico, tela, cuero, goma EVA, fieltro, cartón fotográfico, etc.

Tool for punching and attaching buttonholes. Perforates paper, PVC up to 2mm thick, plastic, fabric, leather, EVA, felt, photo cardboard, etc.

Outil pour perforer et mettre les boutonnières. Perfore le papier, PVC jusqu'à 2mm d'épaisseur, plastique, tissu, cuir, gomme EVA, feutre, carton photographie, etc.

5mm

1



41032

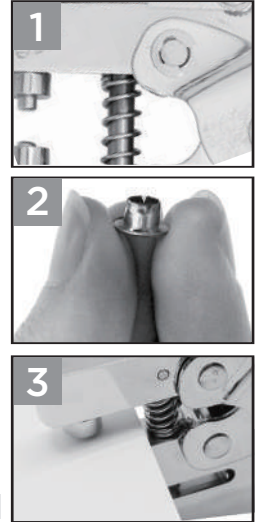

OJALES · GROMMETS · BOUTONNIÈRES

5

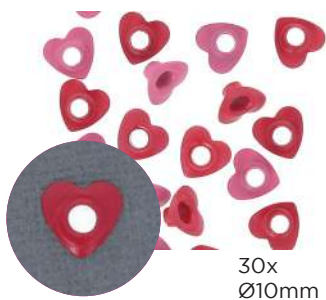

41033

30x
Ø10mm

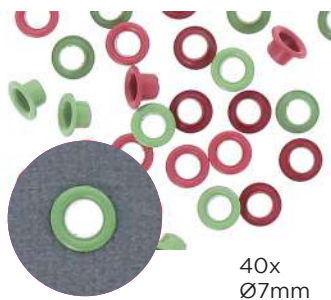

41034

40x
Ø7mm



41035

30x
Ø10mm

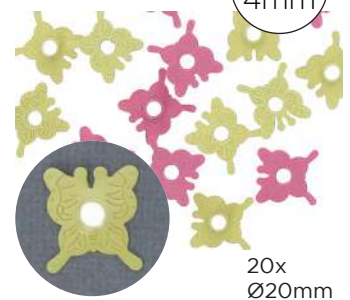

41036

20x
Ø20mm

PERFORADORA · SCREW HOLE PUNCH · PERCEUSE MANUELLE

Perforadora para crear agujeros en cualquier parte del proyecto. Perfora papel, cartón, pergamino, foil, plástico fino, goma EVA, fieltro, tela, cuero, tejano, etc.

It is the perfect tool to make holes anywhere on the project. To punch paper, cardboard, vellum, foil, thin plastic, EVA foam, felt, fabric, leather, denim and more.

Perceuse pour créer des trous sur toute partie souhaitée du projet. Perfore le papier, carton, parchemin, foil, plastique fin, mousse EVA, feutre, tissu, cuir, jean, etc.



41029

2mm - 3mm - 4mm

2

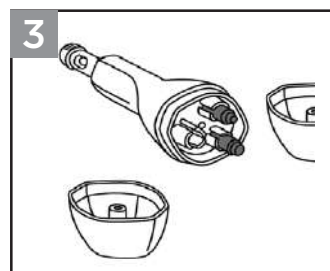
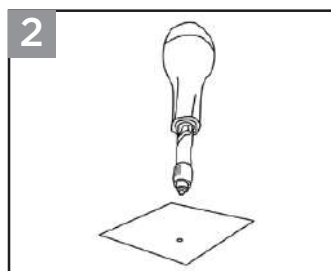
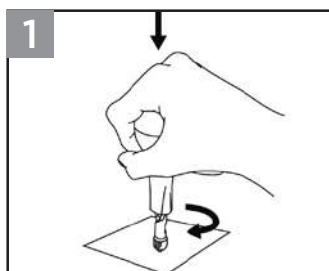



BASES Y HERRAMIENTAS DE CORTE

CUTTING MAT AND CUTTING ARTICLES

TAPIS DE COUPE ET OUTILS À DÉCOUPER

BASES DE CORTE · CUTTING MAT · TAPIS DE DÉCOUPE

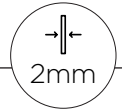

Bases de corte autocicatrizantes con cuadrícula. Ideales para proteger la superficie de trabajo y perfectas para cortar materiales con cúter. Si te gusta realizar trabajos de patchwork, scrapbooking, costura y otros proyectos de manualidades, esta base de corte autocicatrizante será tu mejor aliada.

Self-regulating cutting mat with grid. Ideal for protecting the work surface and perfect for cutting materials with a cutter. If you like to do patchwork, scrapbooking, sewing and other craft projects, this self-healing cutting mat will be your best allied.

Tapis de coupe autocicatrizantes avec 1 face quadrillée. Parfaites pour protéger la surface de travail et pour couper des matériaux avec cutter. Si vous aimez réaliser un travail de patchwork, scrapbooking, couture ou autres projets de loisirs créatifs, autocicatrisant sera votre meilleure alliée.

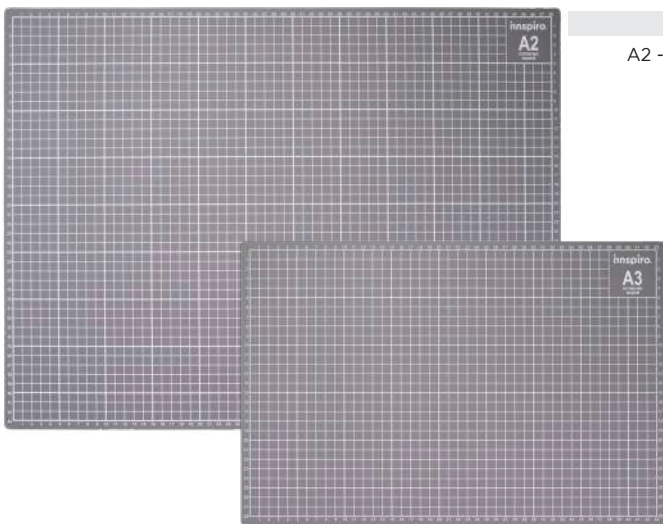

12166

A2 - 60x45cm



12165

A3 - 45x30cm

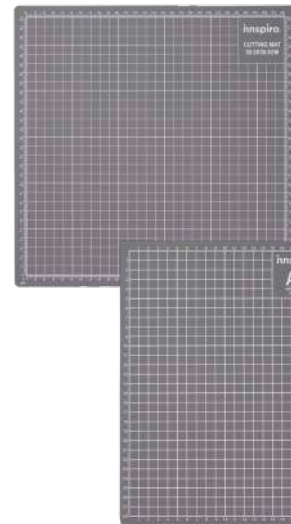

12164

30x30cm



12168

A4 - 22x30cm

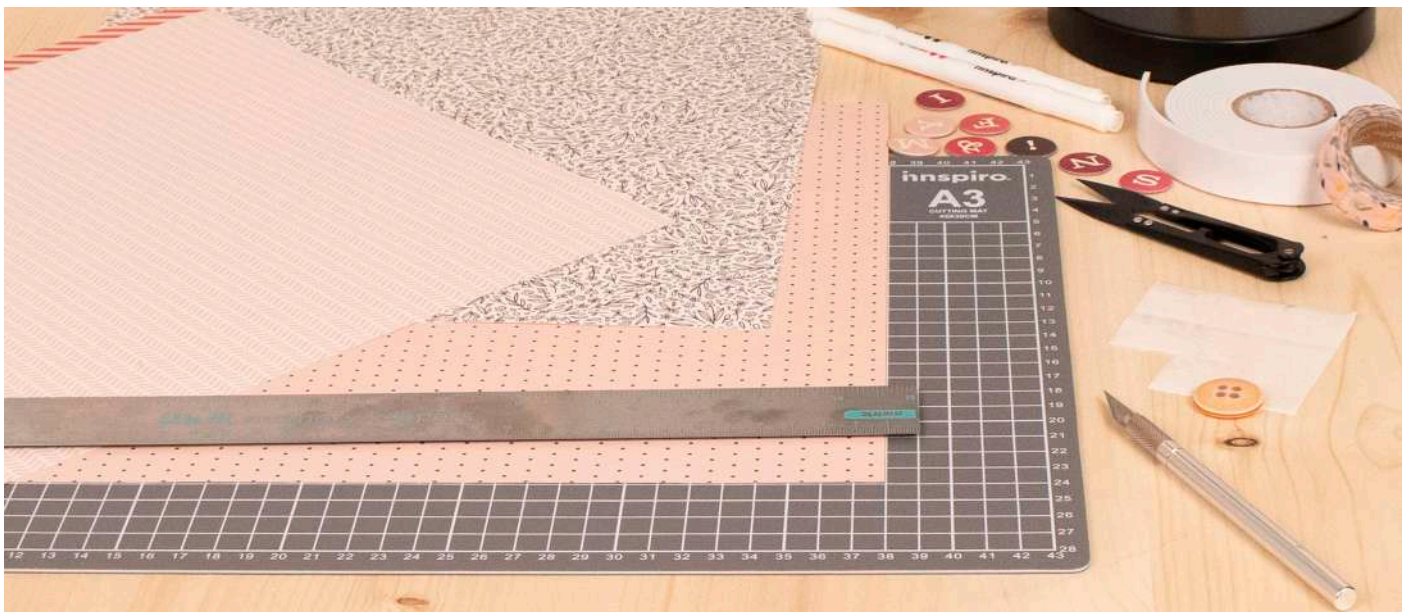

Lápiz cutter metálico +3 puntas
 Metallic pencil with cutter point +3 blades
 Cutter scalpel +3 lames



12101
 17cm
 🗑️ 10

Lápiz cutter metélico
 Métallic pencil with cutter point
 Cutter scalpel métallique



12103
 17cm
 🗑️ 10

Recambio lápiz cutter
 Spare pencil cutter blades
 Lames rechange cutter



12110
 🗑️ 5u
 🗑️ 10

+i
 Adaptable a
 For use with
 Adaptable aux
12101
12103
12106

Cutter pequeño
 Small cutter
 Cutter petit



12170
 🗑️ 24

Cutter grande
 Large cutter
 Cutter grand



12173
 🗑️ 12

Lápiz cutter moldeador + 6 recambios
 Shaping pencil with cutter + 6 spare blades
 Cutter scalpel + ébauchoir + 6 rechanges



12106
 🗑️ 10

HOJAS RECAMBIO · SPARE CUTTER BLADES · LAMES RECHANGE

Pequeña para 12170
 Small for 12170
 Petite pour 12170

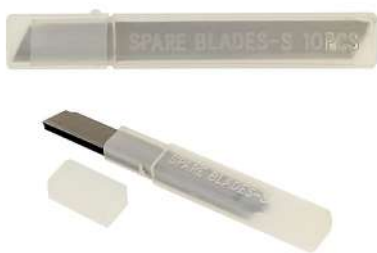

12180
 🗑️ 10u
 🗑️ 10

Grande para 12173
 Large for 12173
 Grande pour 12173



12181
 🗑️ 10u
 🗑️ 5

MICROTIJERAS · MICRO-SCISSORS · MICRO CISEAUX



65388
 9cm
 🗑️ 12



FISKARS®

innspiro®

Distribuye la reconocida y prestigiosa marca FISKARS.

Líder en el mercado del corte: tijeras, cúteres, cizallas... todo tipo de herramientas de corte ideales para cada proyecto.

Distribute the recognized and prestigious brand FISKARS.

Leader in the cutting market: scissors, cutters, shears ... all kinds of cutting tools ideal for each project.

Distribue la reconnue et prestigieuse marque FISKARS.

Leader dans le marché de la découpe : ciseaux, cutters, cisailles... tout type d'outils de découpe parfaits pour chaque projet.

TODOS LOS PRODUCTOS FISKARS EN LA WEB
ALL FISKARS PRODUCTS ON THE WEB
TOUS LES PROJETS FISKARS SUR LE SITE



B2B.INNSPIRO.COM



SCAN



Si deseas tener el catálogo en tus manos, solicítalo. O si lo prefieres en formato virtual; escanea el código QR y visualízalo.

If you want to have the catalog in your hands, request it. Or if you prefer it in virtual format; scan the QR code and view it.

Si vous souhaitez obtenir le catalogue, demandez-le-nous. Ou si vous le préférez en virtuel ; scannez le code QR afin de pouvoir le visualiser.

HERRAMIENTAS PARA MERCERÍA, OFICINA Y ESCOLAR
TOOLS FOR MERCERY, OFFICE AND SCHOOL · OUTILS POUR MERCERIES, BUREAU ET ÉCOLE



01

Tijeras que triunfan en todo el mundo
Scissors that triumph around the world
Ciseaux connus dans le monde entier



02

Cúteres y cuchillos de precisión
Precision knives and cutters
Cutters et lames de précision



03

Cizallas de gran precisión
High precision shears
Cisailles de grande précision



04

Herramientas para el patchwork
Patchwork tools
Outils pour patchwork



05

Perforadoras para grandes proyectos de scrap
Hole punches for big scrap
Perforeuses pour grand projet de scrap



06

Niños
Kids projects
Enfants



●* COLORING

PRODUCTOS PARA COLOREAR

— PRODUCTS FOR COLORING













— GAMME DE PRODUITS À COLORIER



Rotuladores doble punta · Double tip colour pen · Feutres diuble pointe

🛒 12



- | | | | |
|--|---|---|---|
| 
18501 | 
18502 | 
18503 | 
18504 |
| 
18505 | 
18506 | 
18507 | 
18508 |
| 
18509 | 
18510 | 
18511 | 
18512 |

+i

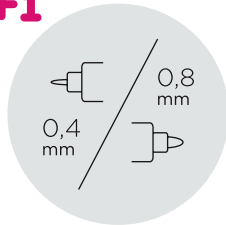

0,4mm
Punta plástico
Plastic tip
Pointe en plastique

0,8mm
Punta poliester
Polyester tip
Pointe en polyester

Expositor · Display · Presentoir

🛒 228u 🛒 1



DIS18500

SETS ROTULADORES · PEN SETS · SET FEUTRES

🛒 1

Set 6 rotuladores
6 Pens sets
Set 6 feutres



18500-06

Set 12 rotuladores
12 Pens sets
Set 12 feutres



18500-12



18201



18202



50mmx5m

🛒 2



18203



18204

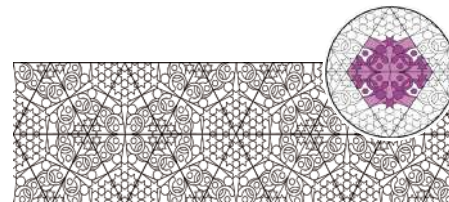

18205



Puedes decorar lo que desees, se adhiere perfectamente en cualquier superficie.

You can decorate what you desire; washi tape sticks on any surface perfectly.

Vous pouvez décorer ce que vous souhaitez, le ruban adhésif washi se colle parfaitement sur n'importe quelle surface.



CUADERNO + lápiz · SKETCHBOOK + pencil · CAHIER D'ESQUISSES + crayon

🛒 1

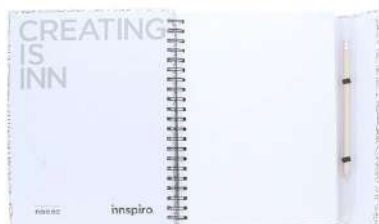
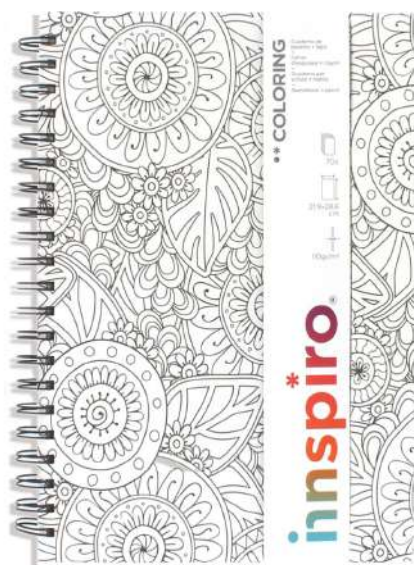

18301

21,9x28,6cm
70 hojas - sheets - feuilles



160gr/m² 16x23cm 2

12 diseños — designs — dessins
24 hojas — sheets — feuilles

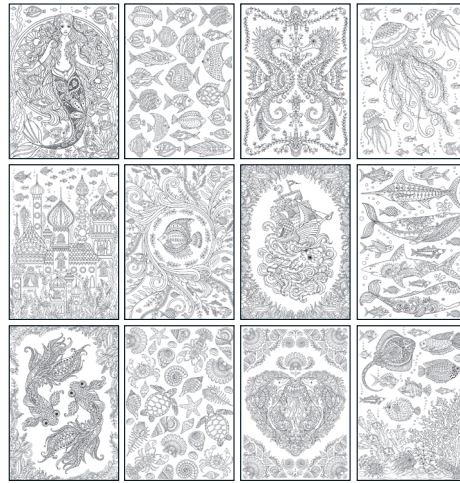

18401

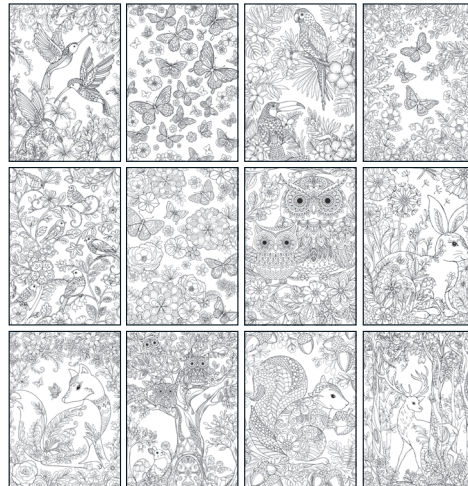

18402

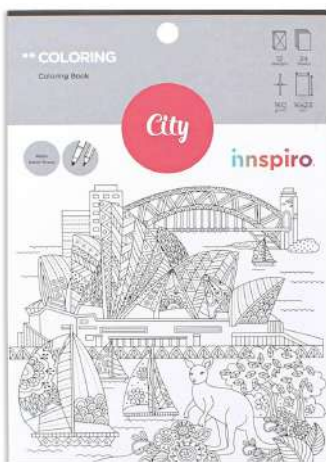

18403

! Puedes colorear también con pintura a base de agua, lápices de colores...

You can also colour using water based paint, colour pencils...

Vous pouvez colorier aussi en utilisant peinture base à l'eau, crayons de couleur...





inspiro. COLORING

inspiro. COLORING

inspiro. COLORING

inspiro. COLORING

inspiro. COLORING

inspiro. COLORING

inspiro. COLORING

inspiro.

inspiro.

inspiro.

inspiro.

inspiro.

inspiro.

inspiro.



ADHESIVOS, COLAS, BARNICES

—
GLUES AND VARNISHES

—
ADHÉSIVES, COLLES, VERNIS

COLA BLANCA · WHITE GLUE · COLLE BLANCHE

 12	
720	100ml
721	250ml
723	1l



		
110010	100gr	12



+i Utilidades: Especial manualidades: madera, corcho, cartón...

Uses: Special arts and crafts: wood, cork, cardboard...

Utilités: Spécial loisirs créatifs: bois, liège, carton...

LÁTEX BRILLANTE · BRIGHT LATEX · LATEX BRILLANT

 12	
741	250ml
743	1l



LÁTEX MATE · MATT LATEX · LATEX MATE

 12	
751	250ml
752	1l



+i Utilidades: Sellador de superficies porosas. Reforzamiento de pinturas. Modificador de pinturas.

Uses: Porous surfaces sealer, paints reinforcement, paints modifier.

Utilités: Poinçon de surfaces poreuses. Pour renforcer les peintures. Pouvoir modifier les peintures.



ARTE-POX



702 250ml 12

+i Cola-laca brillante ideal para superficies porosas.
Glue-laque gloss ideal for porous surfaces.
Colle-laque brillante idéal pour surfaces poreuses.



SUPER-POX



705 250ml 12

+i Cola-laca brillante ideal para superficies no porosas.
Ignífuga, aplicación en velas.
Glue-laque gloss ideal for nonporous surfaces. Flame retardant, application in candles.
Colle-laque brillante idéal pour surfaces non poreuses. Ignifuge, application dans les bougies.



Tubo Gel Rapid Glue
Rapid Glue Gel Tube
Tube Gel Rapid Glue



110005

3gr 24

Adhesivo pincel Rapid Glue
Rapid Glue Brush
Colle Rapid Glue Pinceau



110006

8gr 24

Adhesivo Epoxy 2 componentes
2 component Epoxy glue
Adhésif Epoxy 2 composants



110015

12ml 12



GLUGOT® Rapid Glue es Cianoacrilato líquido, de secaje rápido y fuerte.

GLUGOT® Rapid Glue is a cyanoacrylate in the liquid state. Extremely rapid and strong adherent.

GLUGOT® Rapid Glue est cyanoacrylate liquide qui sèche rapidement et très fort.

Cola base agua secado transparente. Adherencia total sobre papel, tela, plástico, metal, fotos e incluso textil.

Water-based transparent glue. Total adhesion on paper, fabrics, plastic, metal, photos and even textiles.

Colle à base de l'eau de séchage transparent. Adhérence totale sur papier, tissu, plastique, métal, photos inclut le textile.

COLA ESPECIAL CAMAFEOS
ESPECIAL GLUE FOR CAMEOS
COLLE SPÉCIALE POUR CAMÉES



110040

29ml 5

GLUE GEMS
GLUE GEMS
GLUE GEMS



2005015

29ml 5





COLAS SILICONA Y PISTOLAS COLA · SILICONE GLUES AND GLUE GUNS
COLLES DE SILICONE ET PISTOLETS DE COLLE

PISTOLA COLA MINI
MINI GLUE GUN
PISTOLET A COLLE MINI



Con cable
 10-60w
 incluye 2 barras de cola
 Avec câble
 10-60w
 comprend 2 barres de colle
 With cable
 10-60w
 contain 2 glue sticks

4071

Ø7mm 🗑️ 1

PISTOLA COLA SIN CABLE
CORDLESS GLUE GUN
PISTOLET A COLLE SANS FIL



Con base de carga y cable
 15-80w
 Incluye 2 barras de cola
 Avec base de charge et câble
 15-80w
 Comprend 2 barres de colle
 With base load and cable
 15-80w
 Contain 2 glue sticks

4090

Ø11mm 🗑️ 1



BARRAS COLA
BÂTONS DE COLLE
GLUE STICKS



Compatible con 4071
 Compatible avec 4071
 Compatible with 4071

4070

Ø 0,7x10cm 🗑️ 12 🗑️ 12



Compatible con 4090
 Compatible avec 4090
 Compatible with 4090

4075

Ø 1,1x10cm 🗑️ 6 🗑️ 12



Compatible con 4090
 Compatible avec 4090
 Compatible with 4090

4091

Ø 1,1x15cm 🗑️ 6 🗑️ 12

122x10cm 1 6



16154	16155	16156	16157	16158
oro	plata	verde	rojo	azul
gold	silver	green	red	blue
or	argent	vert	rouge	bleu

ADHESIVO FOIL
ADHÉSIF FOIL
FOIL ADHESIVE



16153

100mm 6



Utilidades: Especial para dorar, platear y colorear sobre cualquier superficie.

Uses: Specially to gold, silver and colour on any surface.

Utilités: Spécial pour dorer, argenter et colorier sur toute surface.



MODO DE EMPLEO · INSTRUCTIONS FOR USE
MODE D'UTILISATION:

Limpiar correctamente la superficie. Aplicar el adhesivo especial para foil, ref.16153, sobre la superficie, utilizando un pincel. Esperar hasta que el adhesivo sea transparente, aplicar sobre el adhesivo la parte mate del foil, presionar con los dedos hasta que se adhiera y retirar. Se puede repetir tantas veces como requiera el proyecto.

Clean the surface properly. Apply the adhesive for foil, ref.16153 on the surfaces using the brush.

Wait until the adhesive is transparent, apply the dull part of the foil on the adhesive, press with the fingers until it adheres, and draw back. Repeat as many times as the project need.

Nettoyer correctement la surface. Appliquer l'adhésif spécial pour feuilles d'aluminium ref. 16153 sur la surface utilisant un pinceau. Attendre jusqu'à ce que l'adhésif soit transparent, appliquer sur l'adhésif et enlever. Peut se faire toutes les fois que le demande le projet.

BARNIZ BRILLANTE · BRIGHT VARNISH · VERNIS BRILLANT

12



16404 100ml
16405 250ml

BARNIZ SATINADO · MATT VARNISH · VERNIS MAT

12



16406 100ml
16407 250ml



Barniz base de agua. Excepcional durabilidad. Excelente adhesión. No amarillean.

Water Base Varnish Exceptional durability. Excellent adhesion. Never goes to yellow.

Vernis Base eau. Exceptionnelle durée. Excellente adhésion. Ne jaunit jamais.



González, enjoy. Za
ndia recién... for
España: Pa...
lité davant la inf...
... ..

...
la com...
es a un intere...
... total de...
hemisferi...
... nta nom...
... les an...
... okers
with
... un-
ear
... n

... favo...
... treats, the
... glances are
... wateringly se...
... ticks!

CE
A
M

SCRAPBOOK ADHESIVES

ADHESIVOS

ADHESIVES

ADHESIVES

DISEÑADO PARA QUE TU CREATIVIDAD PERDURE

CARACTERÍSTICAS:

- No contienen ácido, lo que asegura la durabilidad de los proyectos.
- Adhesivos con base acrílica, no traspasa el papel.
- Adhesivos con base de caucho, alta flexibilidad.
- Sin lignina, el papel no amarillea.
- ISO 18916 - PAT - Ensayo de actividad fotográfica, testado y aprobado.
- ISO 18932 - Materiales de formación de imágenes. Sistema de montaje de adhesivos, testado de duración.

PRODUCTOS QUE CUMPLEN TODOS LOS REQUISITOS DE PROTECCIÓN DEL MEDIO AMBIENTE:

- Todos los envases están hechos con un mínimo de un 95% de materiales reutilizados y 100% reciclables
- Todos los envases de cartón están hechos por proveedores certificados en FSC.
- Los residuos son debidamente eliminados y siempre separados de los materiales para el reciclado y su correcta eliminación.
- Se utiliza un promedio del 15% energía eólica en todos nuestros procesos de producción
- Nuestros vendedores y proveedores cumplen con los mismos estándares de eficiencia energética en la producción.

DESIGNED TO MAKE YOUR CREATIVITY LAST™

CARACTERISTICS

- Acid free - no weakening of paper or top-coating of photos.
- Archival safe - No reaction with typical craft materials like photos, paper or cardstock.
- Acrylic based adhesive - No bleeding through paper.
- Rubber based adhesive - High flexibility.
- Ligning free - no yellowing of paper.
- ISO 18916 - PAT - Photographic Activity Test, tested and approved.
- ISO 18932 - Imaging materials - adhesive mounting systems, aging tested adhesive.

ENVIRONMENTAL CONCERNS

- All packaging is made with at least 95% recycled materials and is 100% recyclable.
- All cardboard packaging is made from FSC certified suppliers.
- Production waste properly eliminated by always separating materials for recycling & proper disposal.
- An average of 15% wind power is used in all our production processes.
- Our vendors and suppliers abide by the same energy efficient production standards.
- Our preferred vendors are local to ensure a smaller carbon footprint and enhance sustainability of our environment.



CONÇU POUR DURER VOTRE CRÉATIVITÉ

CARACTERISTIQUES

- Sans acide - aucun affaiblissement de papier ou dégat de la surface de vos photos.
- En acrylique - Sans colorant ni dégorgeement.
- Adhésif sur la base de gomme adhesive - fort et souple.
- Sans Lignine - aucun jaunissement ou décoloration.
- ISO 18916 - PAT - (Sécurité Photo), testé et approuvé.
- ISO 18932 - matériels d'image, systèmes adhésifs de montage, test de vieillissement.

QUESTIONS D'ÉTHIQUE

- Que tous nos emballages contiennent au moins 95% de matériaux recyclés et sont 100% recyclables.
- Que tous nos emballages cartonnés sont produits par des fournisseurs certifiés FSC.
- Que nos déchets industriels sont éliminés proprement puis recyclés.
- Qu'en moyenne 15% d'énergie solaire est employée dans notre processus de fabrication.
- Que nos vendeurs et revendeurs respectent les mêmes normes énergétiques.
- Que nos fournisseurs réduisent au maximum l'emploi de carbone pour se montrer respectueux de l'environnement.



EZ-RUNNER® GRAND

Dispensador recargable de tiras permanentes adhesivas blancas de doble cara, ahora disponible en 45m.

Permanent strips of white double sided adhesive, our most popular adhesive, now available in 45m.

Distributeur rechargeable blanc de bandes adhésives de double-face permanents, disponible en 45m.



El dispensador es muy fácil de manejar por su empuñadura E-Z. Las tiras permanentes son un adhesivo suficientemente versátil para su uso en el hogar, la oficina, la escuela y en artesanía. Recarga fácil de cambiar, no se enrolla ni se enreda. Tira de plástico irrompible (P.E.T). Recargas reciclables.

The dispenser is very easy to handle by its handle E-Z. Permanent adhesive strips are versatile enough for use in the home, office, school and craft. Recharging easy to change, it is not rolled or entangles. Shatterproof plastic strip (P.E.T). Recyclable recharges.

Le distributeur est très facile à manipuler par sa poignée E-Z. Des bandes adhésives permanentes sont suffisamment polyvalent pour une utilisation dans la maison, bureau, école et de l'artisanat. Rechargement facile à changer, il est pas roulé ou empêtre. Bande de plastique incassable (de P.E.T). recharges recyclables. Plus threding, enrroulement, se demander ou gaspiller! Doublure en PET Mylar incassable. Les recharges sont recyclables.

Dispensador
Dispenser
Distributeur

Tiras pre-cortadas para curvas, largo recorrido y pequeños espacios.

Pre-cut Strips for curves, long runs, and small spaces.

Bande prédécoupée pour les courbes, les grandes lignes et les petits espaces.



L01250
45m
2

Recarga
Refil
Recharge



L01251
45m
4



EZ-RUNNER® RECARGABLE · REFILLABLE · RECHARGABLE

Económico, recargas a precios razonables, fáciles de cambiar, usar y fáciles de aplicar con la nueva forma ergonómica del dispensador. Respetuoso con el medio ambiente, con muy pocos residuos y con cartuchos de repuestos. Mezclar y combinar, un dispensador puede contener cualquier recambio. Se puede cambiar el recambio en la mitad del uso, sin que se enrosque o enred. No necesita encajes.

¡La próxima generación de E-Z Runner® adhesivos ya ha llegado!

Economical, value priced refills are easy to change, use, and easy to dispense with the new ergonomic shape of the dispenser. Environmentally friendly with low waste and recyclable Refill cartridges. Mix & Match, one dispenser holds any refill. The refills can even be switched mid-use - no winding, threading or tangling! No paper based liners that snap!

Truly the next generation of E-Z Runner® adhesives has arrived!

Économique, les avantageuses recharges sont faciles à changer, à utiliser, et simples à appliquer avec la nouvelle forme ergonomique du distributeur. Respectueux de l'environnement avec peu de déchets et des cartouches de recharge recyclables. Combinez-les entre eux, un distributeur peut accueillir n'importe quelle recharge. Les recharges peuvent même être changées à mi-usage sans enroulement, enfilage ou enchevêtrement possible ! Pas de base en papier pouvant se casser !

Véritablement la prochaine génération de E-Z Runner® est arrivée !



EZ-RUNNER® tiras permanentes · Permanent strips · Bandes permanentes

Tiras pre-cortadas para curvas, largo recorrido y pequeños espacios.

Pre-cut strips for curves, long runs, and small spaces.

Bande prédécoupée pour les courbes, les grandes lignes et les petits espaces.

Dispensador tira pre-cortada

Dispenser strip-precut
Distributeur bande prédécoupée

Recarga pre-cortada

Refill strip-precut
Recharge bandes prédécoupée



L01200

15m

🛒 6



L01201

15m

🛒 6

Pack Ahorro 1 dispensador y 2 recargas

Value Pack 1 dispenser and 2 refills

Format économique 1 distributeur et 2 recharges

3 Pre-cortada 15m

Refill 15m strip-precut

Recharge bandes prédécoupée 15m



L01231

🛒 8



L01232

🛒 8



Se puede utilizar el adhesivo por la parte exterior y decorarlo con purpurina o arenas. Incluso se pueden aplicar polvos emboss.

You can use the adhesive on the outside and decorate with glitter or sand. Even emboss can be applied dusts.

Vous pouvez utiliser l'adhésif sur l'extérieur et décorer avec des paillettes ou du sable. Même gaufrage peut être appliqué poussières.



E-Z DOTS® permanentes · Permanent · Permanent

+i Puntos para troquelados, curvas, largo recorrido y pequeños espacios.
Dots for die-cuts, curves, long runs, and small spaces.
Pois pour les découpes, les courbes, les grandes lignes et les petits espaces.

Dispensador
Dispenser
Distributeur

Recarga 15m 
Refill
Recharge



L01202



L01203

E-Z DOTS® reposicionables · Repositionable · Repositionnable

+i Adhesivo reposicionable y removible. Ideal para principiantes.
Repositionable and removable adhesive. Great for beginners.
Adhésif repositionnable et amovible. Idéal pour les débutants.

Dispensador
Dispenser
Distributeur

Recarga 15m 
Refill
Recharge



L01204

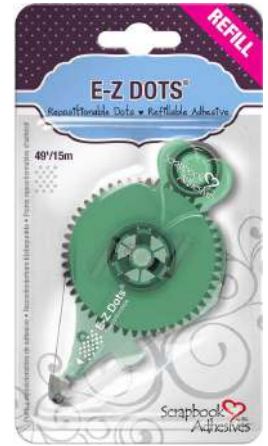

L01205

E-Z Squares® permanentes, lengüetas blancas · Permanent, white tabs · Bande permanente, étiquettes adhésives blanches

+i Lengüetas para fotos, elementos de papel y embellecedores.
Squares for photos, paper elements and embellishments.
Étiquettes pour les photos, les papiers et les embellissements.

Dispensador
Dispenser
Distributeur

Recarga 0,8x1,2cm 
Refill
Recharge



L01206



L01207

E-Z Runner® Transparente, ultra fuerte · Transparent, ultra strong · Transparent, ultra solide

Dispensador
Dispenser
Distributeur

Recarga 13m 
Refill
Recharge



L01234



L01235

E-Z Dots® permanente, 3 recargas · Permanent, 3 refill · Bande permanente, 3 recharge



L01233

- +i** Incluye:
- 2 recargas mini puntos permanentes.
 - 1 recarga mini puntos removible
- It includes:
- 2 mini recharging points permanent.
 - 1 mini recharge points removable.
- Il comprend:
- 2 mini points de recharge permanent.
 - 1 mini-points de recharge amovible.



EZ-RUNNER® ORIGINAL

Diferentes necesidades requieren diferentes herramientas. Con nuestros dispensadores E-Z darás la opción a tus clientes de cubrir todas sus necesidades de adhesivos para la artesanía del papel o scrapbooking. Fácil y precisa aplicación en cualquier superficie, desde pequeños troquelados y fotos hasta vitela y cartulina.

Different needs require different tools. With our E-Z Dispensers, you can give your customers the choice that will fulfill all their scrapbooking and paper crafting adhesive needs. Precise application is a breeze on anything from tiny letter die-cuts and photos to vellum and cardstock.

Des besoins différents nécessitent des outils différents. Avec nos distributeurs E-Z, vous pouvez donner à vos clients le choix qui saura combler tous leurs besoins créatifs. L'application précise est un jeu d'enfant que ce soit sur des petites lettres découpées, des photos, du vélu ou du cartone.

+i **Tiras de plástico irrompible (P.E.T). Utiliza el adhesivo en la parte exterior y decóralo con purpurina o arenas. Incluso puede realizar emboss aplicando calor!**

Unbreakable PET-liner. Wear your adhesive on the outside and decorate the adhesive with foils or glitter. Can be heat-embossed!

Bande en plastique incassable (P.E.T). Utilisez votre adhésif à décourez le de film ou de pailletes. It peut même être.

E-Z RUNNER® Tiras Permanentes · Permanent Strips · Bandes Permanentes

Tiras pre-cortadas blancas para curvas, largo recorrido y pequeños espacios

Pre-cut white Strips for curves, long runs, and small spaces

Bandes blanches prédécoupées pour les courbes, les grandes lignes et les petits espaces

Dispensador Pack Ahorro

Dispenser Value Pack
Distributeur Format Économique

2 Runner

Dispensador Pack Ahorro

Dispenser Value Pack
Distributeur Format Économique

Runner + Squares

Puntos para troquelados, curvas, largo recorrido y pequeños espacios

Dots for die-cuts, curves, long runs, and small spaces

Pois pour les découpes, les courbes, les grandes lignes et les petits espaces



L01644

10m 6



L01646

8,5m 10



L01648

8,5m 10



L01663

15m 6

E-Z RUNNER® Fino · Fine · Fin

Tiras pre-cortadas blancas para curvas, largo recorrido y pequeños espacios

Pre-cut white Strips for curves, long runs, and small spaces

Bandes blanches prédécoupées pour les courbes, les grandes lignes et les petits espaces

15m 6



L01643

E-Z DOTS® Reposicionable · Repositionable · Repositionnable

Puntos de adhesivos reposicionables y removibles. Ideal para principiantes.

Repositionable and removable adhesive dots. Great for beginners.

Adhésif repositionnable et amovible. Idéal pour les débutants.

15m 6



L01640



E-Z RUNNER® Dispensadores pequeños · Small dispenser · Petit Distributeur

Un dispensador pequeño manejable y valioso. Ideal para viajes y convenciones. Incluye un protector para el adhesivo, para asegurar de que ninguna fibra, polvo o purpurinas puedan adherirse en el adhesivo cuando esté cerrado. También disponible en un económico pack.

A small and handy dispenser at a great value. Perfect for traveling and conventions. Includes an adhesive protector, ensuring that no fibers, dust or glitter can come in contact with the adhesive when closed. Also available in a Value Pack.

Un petit distributeur pratique et avantageux. Idéal pour les déplacements et les conventions. Inclut une protection de l'adhésif, vous assurant qu'aucune fibre, poussière ou paillette ne peut entrer en contact avec l'adhésif lorsqu'il est fermé. Également vendu en pack économique.

Mini Reposicionable

Mini Repositionable
Mini Repositionnables

Reposicionable y removable. Para re-diseñar elementos en cualquier momento, tan resistente que puede durar permanentemente. Ideal para principiantes.

Dots for die-cuts, curves, long runs, and small spaces.

Pois pour les découpes, les courbes, les grandes lignes et les petits espaces.



L01671

8m 6



- Fácil de aplicar en curvas, círculos y troquelados complicados.
- Aplicador pequeño, ideal para niños
- Decorar el adhesivo con purpurina, arenas, y más...
- Puede ser en relieve con calor
- Protector del adhesivo integrado
- Tiras de plástico irrompible (P.E.T)
- Easily applied in curves, circles, and on intricate die cuts
- Small sized applicator, great for kids
- Decorate adhesive with glitter, foils and more.
- Can be heat-embossed
- Built-in adhesive protector
- Unbreakable plastic liner (PET)
- S'applique facilement sur les courbes, les cercles et les découpes étroites.
- Applicateur de petite taille, idéal pour les enfants.
- Décorez l'adhésif avec des paillettes, du film et plus encore peut être embossé.
- Protection adhésif intégrée.
- Bande en plastique incassable (P.E.T).

Mini Permanente

Mini Permanent
Mini Permanente



L01670

8m 6

Mini Permanente

PACK AHORRO
Mini Permanent
Value PACK
Mini Permanente
PACK ÉCONOMIQUE



L01672

8x3m 6



El adhesivo favorito de los artesanos del papel. Puedes personalizar el dispensador con fotos e insertar tu diseño, siendo una extensión de ti y tu estilo. MyStik™ ofrece un sistema patentado de recambios intercambiables para cada dispensador. El sistema más fácil de recargar del mercado. Simplemente alinea las flechas y encaja dentro y fuera. Ningún rebobinado, roscado o enredo. No necesita encajes ¡Y es reciclable!

A paper crafter's favorite adhesives. Customize it with photos or other inserts you design and make it an extension of you and your style. MyStik™ offers a patented interchangeable refill system for each dispenser. The easiest refill on the market. Simply line up the arrows and snap in or out. No winding, threading or tangling. No paper based liners that snap. And it's recyclable!

L'adhésif préféré des personnes créatives. Vous pouvez les personnaliser avec des photos ou d'autres insertions que vous créez, reflétant la continuation de votre personnalité de même que votre style. MyStik™ offre un système de recharge brevetée interchangeable pour chaque distributeur. La recharge la plus simple sur le marché. Alignez simplement les flèches et fermez d'un coup sec ou pressez pour faire sortir. Pas d'enroulement, d'enfilage ou d'enchevêtrement. Pas de bandes sur base papier qui se cassent. Et c'est recyclable!

MyStik™ Puntos Reposicionables · Repositionable dots · Pois repositionnables

15m  6

Dispensador
Dispenser
Distributeur

Recarga
Refill
Recharge

Dispensador + 2 recargas
Dispenser + 2 refills
Distributeur + 2 recharges

3 Recarga
3 Refill
3 Recharge

 8

 10



L01653



L01658



L01631



L01632

+i Adhesivo repositionable y removable. Para re-diseñar elementos en cualquier momento y tan resistente que puede durar permanentemente. Ideal para principiantes.

Repositionable and removable adhesive. Reposition design elements at any time, yet strong enough to hold permanently. Great for beginners.

Adhésif repositionnable et amovible. Repositionner vos éléments à tous moments. Il reste suffisamment résistant pour fixer de façon permanente. Idéal pour les débutants.



Empuñadura protectora y ajustable
Protective and adjustable grip
Poignée de protection réglable



Personalizar y decorar con plantilla incluida
Customize and decorate with template included
Personnaliser et décorer avec modèle Inclus



Mezclar y combinar
Mix and match
Mélanger et combiner





CINTAS CRAFTY POWER · CRAFTY POWER TAPES · ADHÉSIVE CRAFTY POWER

Una cinta de super adherencia, translúcida y de alta calidad. Nuestra cinta Crafty Power Tape es muy simple de aplicar en cualquier elemento de artesanía, desde papel, lienzo, tela, madera, metal, fotos y adornos gran de tela. Decorar con purpurina, arenas, y más para un efecto divertido. También se puede realizar embossing.

A super-high tack, translucent crafting tape. Our Crafty Power Tape makes it easy to apply any papercrafting item from paper, canvas, wood, metal, photos and heavy embellishments. Crafty Power Tape is the perfect size for ribbon too! Decorate adhesive with glitter, foils, and more for a fun effect. Can even be heat embossed.

Ruban translucide de super-haute adhérence. Notre Crafty Power Tape est facile d'appliquer sur n'importe quel papier, toile, ruban, bois, métal, photos et embellissements lourds. Crafty Power Tape a également une taille parfaite pour les rubans! Décorez votre adhésif avec des paillettes, du film et plus encore pour un superbe effet. Peut aussi être embossé.

Dispensador cintas recargable
Refillable tape dispenser
Distributeur ruban rechargeable

Recarga. Se adapta a la mayoría de dispensadores
Refill. Fits most tape dispensers
Recharge. S'adapte à la plupart des distributeurs de ruban adhésif

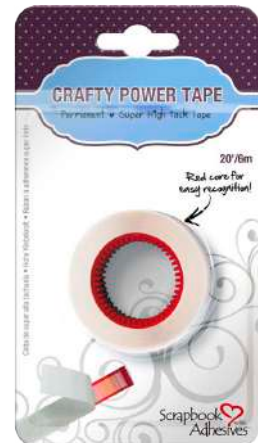

L01638

L01637

L01636

25mx6mm 🛒 12

6mx6mm 🛒 24

🛒 30

KIT INICIACIÓN DE ADHESIVOS · ADHESIVE STARTER KIT · PAQUET ADHÉSIVE DU DÉBUTANT

CONTENIDO

- 1x1 E-Z Runner® Tiras Permanentes (8m)
- 1 caja de Pastillas Adhesivas (250 unidades permanentes blancas)
- 3D Foam Squares - Regulares (11x12x2mm)
- Esquinas para fotos creativas (36 blanco - 36 negro)
- Crafty Power tape (6m)

CONTENS

- 1x1 E-Z Runner® Permanent Strips (8M)
- 1 box of Mounting Squares (250 tabs permanent white)
- 3D Foam Squares - Regular (63 White 11x12x2mm)
- Creative Photo Corners (36 white - 36 black)
- Crafty Power Tape (6m)

CONTENU

- 1x1 E-Z Runner® bande permanente (8m)
- 1 boîte de Carrés de Montages (250 languettes blanches permanentes)
- Feuille de Carrés 3D en Mousse (11x12x2mm)
- Coins de Papier Photo (36 blancs, 36 noirs)
- Crafty Power Tape (6m)

CONTENIDO

- 1x1 E-Z Runner® Tiras Permanentes, Dispensador recargable
- 1x1 E-Z Dots® Reposicionable Recargable
- Crafty Power Tape
- 3D Foam Squares - Pequeños (blanco y negro)
- 3D Foam Squares - Regulares (blanco)
- DodZ™ - Medio
- Hoja de adhesivos
- Corazones de espuma 3D - blanco
- Esquinas para fotos creativas
- Sobres de clasificación

CONTENS

- 1x1 E-Z Runner® Permanent Strips Refillable Dispenser
- 1x1 E-Z Dots® Repositionable Refill Crafty Power Tape
- 3D Foam Squares - Small (white and black)
- 3D Foam Squares - Regular (white)
- DodZ™ - Medium Adhesive Sheet
- 3D Foam Hearts - White
- Creative Photo Corners
- Keepsake Envelopes

CONTENU

- 1x1 E-Z Runner® à bande permanente, distributeur
- 1x1 E-Z Dots® repositionnable, recharge
- Bande Adhésive Artistique
- Carrés adhésifs en mousse 3D - Petit modèle (blanc et noir)
- Carrés adhésifs en mousse 3D - Modèle standard (blanc)
- DodZ™ - Moyen
- Feuille adhésive
- Coeur en mousse 3D - Blanc
- Coins pour photos créatifs
- Enveloppes souvenir



L01697

L01290

🛒 1

🛒 1

Crea adornos de espuma 3D para tarjetería, páginas de scrapbooking y mix media mediante la combinación de nuestros diseños de formas con purpurina, arenas, polvos emboss, polvos pigmento, y más. Las piezas múltiples de cada paquete te dan valiosas y ilimitadas opciones creativas. Mezcla y combina las formas de cada paquete para más diversión y versatilidad.

Create 3D foam embellishments for cards, scrapbook pages and mixed media, by combining our designer shapes with glitter, foil, embossing powder, pigment powder and more! Multiple pieces in each package provide endless creative options at a great value. Mix and match the shapes in each set for even more fun and versatility.

Créez des embellissements en mousse 3D pour vos cartes, pages de scrapbooking et mixed media, en combinant nos designer shapes avec des paillettes, du film, de la poudre d'embossage, des pigments et plus encore! Les multiples unités de chaque paquet vous procurent d'infinies options créatives de façon économique. Combinez les formes de chaque set pour plus de fun et de créativité.

+i

- Espuma de alta densidad, alta resistencia y de doble cara. Hojas de 1mm y 2mm.
 - Revestimiento fácil de quitar.
 - Ideal para dimensiones en p .e. tarjetas, scrapbooking y mix media.
 - También ideal para proyectos escolares.
 - Utiliza tu adhesivo en la parte exterior y decora con purpurina, flocado, arenas, polvos que repuljan etc....Tambien se puede realizar emboss aplicando calor.
-
- High density high-tack double-sided foam.
 - Sheets of 1mm and 2mm.
 - Easy release liner effect for dimension on e.g. cards, scrapbooks and mixed media, great for school projects too!
 - Wear your adhesive on the outside and decorate with glitter flocking, foils, embossing powder, etc. Can even be heat embossed!
-
- Mousse double-face à forte adhérence de haute densité.
 - Feuille de 1mm et 2mm.
 - Film protecteur facile à enlever.
 - Parfait pour donner de la dimension sur vos cartes, projets de scrapbooking etc...mixed. media, également idéal pour les projets d'école.
 - Utilisez votre adhésif à découvert et décidez le de film ou de paillettes. Il peut même être embossé !

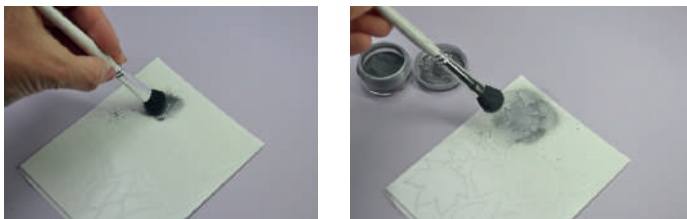
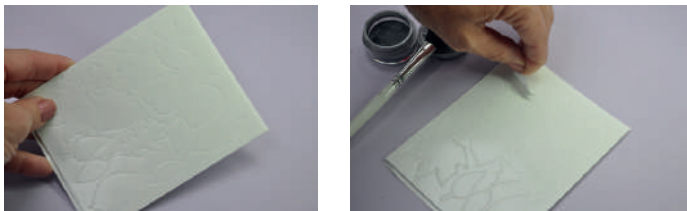



DISEÑOS DE FORMAS EN ESPUMA 3D · DESIGNER SHAPES IN 3D FOAM · DESIGNER SHAPES EN MOUSEE 3D

10

Corazones
Hearts
Coeurs



L01208
48mix

Árboles
Trees
Arbres



L01210
20mix

Estrella
Star
Etoile



L01211
48mix

Marcos
Frames
Cadres



L01212
20mix

Banderines
Pennants
Bannières



L01213
100mix

Alas
Wings
Ailes d'ange



L01214
32mix

Hojas
Leaves
Feuilles



L01215
28mix

Copos de nieve
Snowflakes
Flocons de neige



L01216
58mix

Formas de navidad
Christmas shapes
Formes de Noël



L01217
54mix

Formas del jardín
Garden shapes
Dessin de jardin



L01218
58mix

Magdalenas
Cupcakes
Cupcakes



L01219
48mix

Pascua
Easter
Pâques



L01220
32mix

Fiesta
Party
Fête



L01221
48mix

Mariposas
Butterflies
Papillons



L01222
26mix

Hojas creativas
Creative sheets
Plaques créatives



L01223
2mix

Dodz™ son adhesivos transparentes y de doble cara, fáciles de usar. Tienen un fuerte adhesivo que los hace perfectos para superficies complejas, objetos y decoración. También son perfectos para objetos pequeños, tanto para adherirse al papel como cartulina. Los Dodz™ son unos adhesivos fuertes y flexibles, con fuerte fijación a superficies complejas/objetos. La aplicación se hace fácil con el dispensador de puntos simples, únicos y patentado, sin necesidad de tocarlos.

Dodz™ is a double-sided, clear adhesive easy to use. They have a strong bond making them perfect for intricate surfaces, objects and decorating. They can be used for smaller objects as well as to adhere paper or cardstock. The Dodz™ are a strong and flexible adhesive with a strong bond to intricate surfaces/objects. Application is made easy with the unique and patented single-dot dispenser without touching the adhesive dots.

Dodz™ est un adhésif double face, transparent facile à utiliser. Ils possèdent une forte fixation qui les rendent parfaits pour une utilisation dans des surfaces plus difficiles, en décoration ou sur des objets. Ils peuvent être utilisés pour des objets plus petits ou même pour coller du papier ou du carton. Les Dodz sont des adhésifs forts et flexibles avec une forte fixation pour les surfaces plus difficiles. L'application est facile avec un distributeur à point unique breveté sans contact avec les points de colle.



10

Dodz™ Pequeño
Small
Petit

Dodz™ Mediano
Medium
Moyen



L01300
6mm



L01301
8mm

Dodz™ 3D

Dodz™ Mini



L01302
12mmx2mm



L01304
5mm

Puntos adhesivos de goma INNINSPIRO
Adhesive dots INNINSPIRO
Points adhésifs INNINSPIRO



Ø 12mm. ± 0,40mm.

4096

5 36

+i

Puntos transparentes autoadhesivos. Ideal para adornos y papel. Fuerte y flexible fijación en la mayoría de las superficies. Aplicación fácil, sin necesidad de tocar. Transparente, plano y invisible bajo tus adornos.

Clear self-adhesive dots. Great for embellishments and paper. Strong and flexible bond on most surfaces. Easy, touch free application. Clear, flat and invisible under your embellishments.

Points autocollants transparents. Idéal pour les embellissements et le papier. Fixation forte et flexible sur la plupart des surfaces. Facile application facile sans contact direct. Transparent, plat et invisible sous vos embellissements.





Puntos adhesivos de espuma 3D de alta densidad que aseguran una fuerte permanencia, facilidad de uso y gran volumen para cualquier página de scrapbooking o artesanía. Disponibles en blanco y negro, usar espuma blanca sobre un fondo claro y espuma negra sobre un fondo oscuro. En 2 tamaños, normal o pequeño, que ofrecen una manera fácil de hacer sobresalir los adornos de la página sin problemas, incluso los más pequeños y estrechos.

High-density 3D Foam Squares will ensure strong permanence, ease-of-use, and great dimension for any scrapbook page or papercraft project. Available in black and white colors, use white foam on light backgrounds and black foam on dark backgrounds. Regular or small sizes, which offer a way to make even tiny or narrow embellishments pop off the page without any hassle!

Pastilles d'adhésif mousse 3D d'haute densité qui assurent une forte permanence, facilité d'utilisation et grand volume pour n'importe quelle page de scrapbooking ou papercraft. Disponible en blanc et noir, utilisez le mousse blanche sur un fond clair et le mousse noire sur un fond sombre. En 2 tailles, standard et petit, qui offrent un moyen de faire même minuscules ou étroites embellissements pop hors de la page sans aucun tracas!

10

Regular blanco
Regular white
Standard blanc



L01610
11x12x2mm 126

Pequeño blanco
Small white
Petit blanc



L01612
6,35x6,35x2mm 308

Pequeño negro
Small black
Petit noir



L01613
6,35x6,35x2mm 308

Mixto blanco
Mixed white
Mixte blanc



L01614
63 regular + 154 pequeñas

Mixto negro
Mixed black
Mixte noir



L01615

Adhesivo espuma 3D INNSPIRO
3D Foam Square INNSPIRO
Adhésif mousse 3D INNSPIRO



5x5mm. 2mm.

4092

400 10

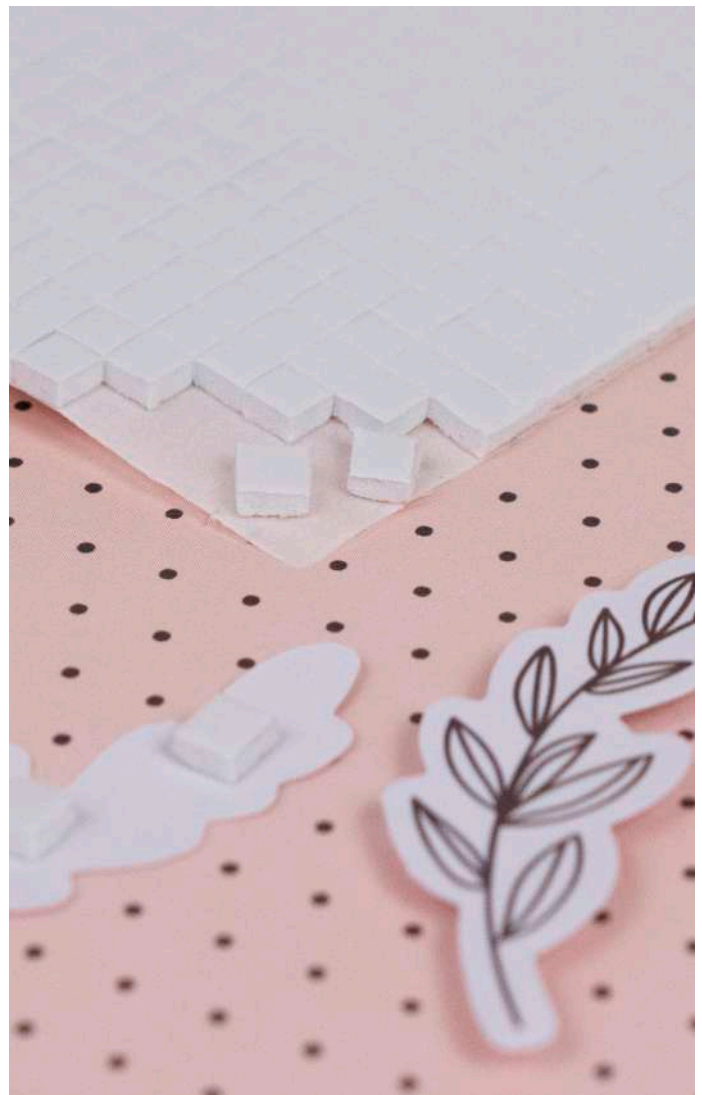

Ideal para tarjetería, envíos y álbumes, permitiendo dimensión sin volumen. Ideal para dimensión discreta en p.e. adornos y botones. Disfruta de ambos colores de nuestros puntos de espuma delgadas, en tamaño mediano o pequeño, que ofrecen una manera fácil de hacer sobresalir los adornos más pequeños y estrechos de la página sin problemas.

Great for cards mailings and albums allowing dimension without bulkiness. Perfect for discreet dimensioning in e.g. embellishments and with buttons. Enjoy both colors of our Thin 3D Foam Squares in regular or small sizes, which offer a way to make even tiny or narrow embellishments pop off the page without hassle!

Ces carrés adhésifs, parfaits pour des cartes, lettres et albums photo, apporteront du relief sans faire de renflement. Parfaits pour donner du relief aux petits embellissements comme par exemple des boutons. Ces carrés adhésifs 3D haute densité vous assureront une fixité solide, une utilisation facile ainsi qu'une protection facile à ôter. Disponibles en 2 couleurs (blanc ou noir) et 2 tailles (normales ou petites), les carrés mousses mettront en valeur même les plus petits embellissements de vos réalisations, sans aucune difficulté!

10

Blanco
63u mediano + 154u pequeño
White
Regular + small
Blanc
Standard + petit

Negro
63u mediano + 154u pequeño
Black
Regular + small
Noir
Standard + petit



L01616



L01617

CRAFTY FOAM TAPE

Una cinta de espuma permanente, resistente y de doble cara. Ideal para aluminio, madera, canvas, etc. Esta cinta de espuma asegura una adherencia fuerte y no se aplasta ni derrite al aplicar emboss. Ideal para añadir dimensión en tarjetas, scrapbooking y mix media. Fácil revestimiento. Ideal para hacer capas. Decorar el adhesivo con purpurina, arenas y más.

A strong permanent double-sided foam tape. Great for metal, wood, canvas, etc. This high-density foam, will ensure strong permanence and will not crush or melt when heat embossing. Perfect for adding dimension to cards, scrapbooks, and mixed media. Easy to peel from liner. Great for layering and stacking. Decorate adhesive with glitter, foils, and more.

Un adhésif haute densité à double face en mousse. Parfait pour le métal, le bois, la toile, etc. Cette mousse à haute densité, assurant une adhésion forte et permanente ne fondra pas lors de l'embossage à chaud. Parfait pour donner du relief à vos cartes, projets de scrapbooking et mixed media. Protection facile à enlever. Parfait pour les couches et les superpositions. Décorez l'adhésif avec des paillettes, du film et plus encore.

10x2mm x 4mm 10

Cintas de Espuma Blanco
Crafty Foam Tape-White
Ruban adhésif en mousse-blanc

Cintas de Espuma Negro
Crafty Foam Tape-Black
Ruban adhésif en mousse-noir



L01618



L01619

Cinta adhesiva espuma INN SpiRO

Crafty foam tape INN SpiRO
Ruban adhésif en mousse INN SpiRO



@ 19mmx228cm. -| 2mm.

4095

12

+

Usar espuma blanca sobre fondos claros y espuma negra sobre fondos oscuros. Ideal para proyectos grandes y para pegar bandas alrededor de bordes. Fácil revestimiento.

Use white foam on light backgrounds and black foam on dark backgrounds. Perfect for larger projects and great for layering borders and ribbons even around edges. Easy release liner.

Utilisez des carrés 3D minces blancs sur un fond clair et des carrés noirs sur un fond sombre. Parfait pour de grands projets et idéal pour les bords, les rubans et les coins. Protection facile à enlever.

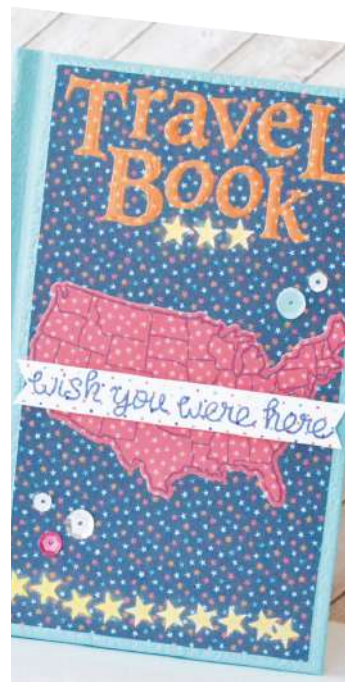



ESQUINAS PARA FOTOS, POLIPROPILENO · PHOTO CORNERS, POLYPROPYLENE · COINS PHOTOS, POLYPROPYLÈNE

La evolución de un clásico. Nuestras esquinas para fotos son autoadhesivas y convenientemente empaquetadas en un rollo y en una caja de 250 unidades. Están libres de PVC, son autoadhesivas y fáciles de usar. Pueden modificarse con tinta permanente o alcohol. Haz capas y decora para un efecto divertido.

20 250

Negro
Black
Noir

Transparente
Transparent
Transparent



L01669



L01674

An evolution of a classic! Our Polypropylene Photo Corners are self-adhesive, and conveniently packaged on a roll in a box of 250u. They are PVC free, self-adhesive and easy to use. Can be altered with permanent or alcohol ink. Stack, layer and decorate for fun effects.

Une évolution du modèle classique! Nos Coins Photos Polypropylène sont auto-adhésifs, et correctement emballés sur un rouleau dans une boîte de 250u. Ils sont sans PVC, auto-adhésif, simple d'utilisation. Ils peuvent être décorés avec des encres permanentes ou à l'alcool. A empiler ou superposer et décorer pour un effet plus fun.

ESQUINAS PARA FOTOS · PHOTO CORNERS · COINS PHOTOS

¿Recuerdas las esquinas tradicionales para fotos que se tenían que mojar y pegar? Ahora hay una manera más fácil de resaltar tus fotos utilizando esquinas para fotos autoadhesivas. Convenientemente empaquetadas en hojas, estas esquinas para fotos no se quedan pegadas unas con otras en el paquete. Sin lignina, no dejarán marcas en tus fotos. Autoadhesivas y fáciles de usar. Se creativo/a y úsalas como adornos o bandas. Personaliza con tinta, tiza y más. Haz capas y decora para un efecto divertido.

Remember the traditional photo corners you had to lick and stick? Now there's an easier way to accent photos by using our self-adhesive, paper Creative Photo Corners! Conveniently packaged on sheets, these Photo Corners won't get stuck to each other in the package! Lignin free, will not stain your photos. Self-adhesive and easy to use. Be creative and use them as embellishments or pennant banners. Customize with ink, chalk, and more. Stack, layer and decorate for fun effects.

Une évolution du modèle classique! Nos Coins Photos Polypropylène sont auto-adhésifs, et correctement emballés sur un rouleau dans une boîte de 250. Ils sont sans PVC, auto-adhésif, simple d'utilisation. Ils peuvent être décorés avec des encres permanentes ou à l'alcool. A empiler ou superposer et décorer pour un effet plus fun.

10 108

Oro
Gold
Or



L01625

Negro
Black
Noir



L01626

Plata
Silver
Argent



L01627

Blanco
White
Blanc



L01628

Marfil
Ivory
Ivoire



L01629

Natural
Craft
Marron



L01630

Mixto
Mixed
Mixte

18u negro · black · 3 noir
8u blanco · white · blanc
12u plata · silver · argent
12u oro · gold · or
6u natural · craft · marron
6u marfil · ivory · ivoire



L01633



Con nuestros puntos adhesivos podrás disfrutar de una aplicación simple, limpia, sin necesidad de tocar. No dejan residuos o manchas, como ocurre con otros productos de caucho a base de pegamento. Son ideales para el montaje de fotos y una amplia variedad de otros materiales para scrapbooking.

When using our Mounting Squares, you'll enjoy a no-mess, touch free application that won't leave any residue or staining behind like other rubber based glue products can! They are perfect for mounting pictures and for a variety of other scrapbooking materials.

En utilisant nos pastilles adhésives, vous apprécierez une application simple ne laissant aucun résidu ou coloration derrière comme d'autres colles à base de caoutchouc peuvent le faire! Ils sont parfaits pour les montages photos et pour toute une variété d'autres matériels de scrapbooking.

20

Pequeño
Small
Petit



L01602

6x13mm 500

Mediano
Medium
Moyen



L01603

12x13mm 250

Mediano
Medium
Moyen



L01604

12x13mm 500

TEMPORALMENTE REPOSICIONABLES 500 Y 1000 UNIDADES

INITIALLY REPOSITIONABLE 500 TABS OR 1000 TABS

TEMPORAIREMENT REPOSITIONNABLES 500 UNITÉS OU 1000 UNITÉS

Nuestros Puntos Adhesivos Temporalmente Reposicionables son una solución extraordinaria para esos momentos "sólo en caso de". Puedes reposicionar tu adhesivo durante los primeros 5 minutos de la aplicación de los puntos adhesivos. Pasados 5 minutos el adhesivo tendrá una fuerte adhesión.

Our initially repositionable Mounting Squares are a remarkable solution for those "just-in-case" moments. For 5 minutes after application, the square of adhesive can be repositioned. After the 5 minutes is up, a strong bond is left behind.

Nos Pastilles Adhésives Temporairement Repositionnables sont une solution remarquable pour ces moments «juste au cas où». Pendant les 5 minutes qui suivent l'application, le Pastille d'adhésif peut être repositionné. Après ces 5 minutes, le pastille adhère fortement à son support.

Puntos adhesivos mediano
Mounting squares regular
Pastilles adhésives standard



L01605

12x13mm 500

20



+i

Adhesivo permanente, blanco y de doble cara. Temporalmente reposicionable durante los primeros 5 minutos.

White permanent, double-sided adhesive. Temporarily repositionable for first 5 minutes.

Adhésif double face, permanent. Repositionnable pendant les premières 5 minutes.



PUNTOS ADHESIVOS CLICK N'STICK · MOUNTING SQUARES CLICK N'STICK · CARRÉES ADHÉSIVES CLICK N'STICK

Puntos Adhesivos de Click n´Stick™ Blanco (500 y 100u.) o Transparente (500u.). Para scrapbookers y artistas de artesanía del papel que quieren una aplicación limpia, el sistema patentado Mounting Squares es una solución perfecta. ¡Con su propio distribuidor integrado y 500/1000 unidades de adhesivo blanco o transparente, las pastillas adhesivas Click n´Stick™ son muy valoradas!

Adhesives points Click n´Stick™ White (500 and 1000u.) or Transparent (500u.). For scrapbookers and paper craft artists who want a clean application, the patented Mounting Squares are a perfect solution. With its own built-in applicator and 500/1000 tabs of permanent white or clear adhesive, Click ´n Stick™ Mounting Squares are a great value!

Adhésifs points Cliquez n´Stick™ Blanc (500 et 1000u.) ou transparents (500u.). Pour scrapbookers et artistes d´artisanat en papier qui veulent une application propre, les équerres de montage breveté sont une solution parfaite. Avec son propre applicateur intégré et 500/1000 onglets de colle blanche ou claire permanente, cliquez sur ´n bâton Carrés de montage™ sont une grande valeur!

Blanco
White
Blanche



L01600
10x13mm 500
20



L01609
10x13mm 1000
6

SOBRES RECUERDO SURTIDOS KEEPSAKE · KEEPSAKE ENVELOPES ASSORTED · ENVELOPPES SOUVENIR ASSORTIMENT

Ya se trate de un mechón de pelo, de un boleto o monedas especiales, nuestros Keepsake Envelopes te garantizan un almacenamiento seguro para los próximos años. Ideal para almacenar recuerdos en tarjetas y scrapbooking. Solapa con cierre. Para uso continuado. La parte posterior es autoadhesiva y permanente. Pueden ser decorados con tinta acrílica y mucho más.

Whether it be a lock of hair, a ticket stub or special coins, our Keepsake Envelopes will ensure safe storage for years to come. Perfect for storing keepsakes to cards and scrapbooks. Re-sealable flap for continuous use. Permanent self-adhesive back. Can be decorated with acrylic paint and much more.

Que ce soit une mèche de cheveux, un talon de billet ou des pièces spéciales, nos Enveloppes souvenir vous assureront un rangement sûr pour les années à venir. Parfait pour conserver des souvenirs dans vos cartes et vos réalisations de scrapbooking. Rabat refermable pour une utilisation continue. Dos auto-adhésif permanent. Peut être décoré avec de la peinture acrylique et bien plus encore.

- 4 pequeño - 4 small- 4 petit 52x51mm**
- 3 mediano - 3 regular - 3 moyen 105x54mm**
- 2 grande - 2 large - 2 grande 105x92mm**
- 1 jumbo 127x117mm**



L01662
6



Creadas específicamente para el uso del troquelador, no se adhieren a los elementos troquelados. Las hojas adhesivas proporcionan una aplicación muy resistente, con cobertura transparente, de borde a borde, sin fibras. Úsalas para crear tus propias pegatinas o para agregar un toque extra a tus diseños con purpurina, flocado, arenas, microperlas, etc. Queda transparente con acrílica y vitela ligera. Queda transparente al pegar.

Specifically created for die-cutting machines and punches and will not gum up the cutting elements, Adhesive Sheets give you incredibly strong, clear edge-to-edge coverage without stringy application. Use them to create your own stickers or to add extra flair to your designs with glitter, flocking, foil, microbeads, anything! Becomes invisible with acrylics and light weight vellum, keeps it clear when you adhere!

Spécialement créées pour les machines de découpes et les perforatrices sans abîmer les éléments de coupe, les Feuilles Adhésives vous offre une couverture totale, nette et résistante, facile à appliquer! Utilisez-les pour faire vos propres autocollants ou ajouter une épaisseur à vos créations avec une couverture totale de paillettes, papier aluminium, petites perles, ou ce que vous voulez! Devient invisible avec de la peinture acrylique et du véllum de faible grammage - maintenez le transparent lors de la fixation!



6



L01680

10x15mm 🍷 10



L01682

15x30,5mm 🍷 5



L01679

30,5x30,5mm 🍷 25 🛒 1



L01683

30,5x30,5mm 🍷 5 🛒 1



Utilice las láminas autoplastificables en cualquier lugar para proteger sus documentos de la lluvia, las heladas, la humedad y la suciedad. Las láminas autoplastificables son especialmente adecuadas para plastificar fotos, collages, dibujos de niños, manteles individuales, recetas, horarios de la escuela etc. ¡Sin necesidad de máquinas!

- Libres de ácido
- Seguras con sus documentos
- Seguras con sus fotos

Use self-laminating sheets anywhere to protect your documents from rain, frost, moisture and dirt. Self-laminating sheets are especially suitable for laminating photos, collages, children's drawings, individual tablecloths, recipes, school schedules, etc. No need for machines!

- Acid free
- Secure with your documents
- Secure with your photos

Utilisez les feuilles de autoplastificables partout pour protéger vos documents de pluie, le gel, l'humidité et la saleté. Les feuilles de autoplastificables sont particulièrement appropriés pour les photos de plastification, collages, dessins d'enfants, des napperons, des recettes, des horaires scolaires, etc. Pas besoin de machines!

- Acide libre
- En toute sécurité avec des documents.
- En toute sécurité avec vos photos

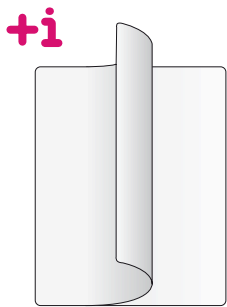

Láminas autoplastificables ideales para fotos, puntos de libro, etiquetas para el jardín y otros productos, billetes, felicitaciones, etc.

Self-laminating foils ideal for photos, bookmarks, garden tags and other products, banknotes, congratulations, etc.

Feuilles autoplastificables idéal pour les photos, signets, étiquettes pour le jardin et d'autres produits, billets, cartes, etc.

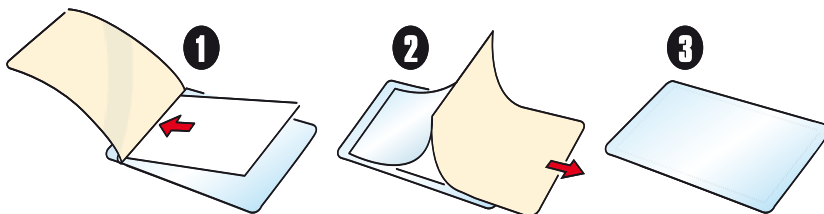

Sitúe la lámina autoplastificable con el lado transparente hacia arriba. Abra la hoja transparente y sitúe su foto, tarjeta u proyecto con la imagen boca arriba bajo la hoja transparente. Cierre la lámina autoplastificable sobre el documento.

Place the self-laminating sheet with the transparent side facing up. Open the transparent sheet and place your photo, card or project with the image face up under the transparent sheet. Close the self-laminating sheet on the document.

Placez la feuille avec transparente autoplastificable vers le haut. Ouvrez la feuille transparente et placez votre photo, carte ou projet avec le visage d'image sous la feuille transparente. Fermez la feuille autoplastificable sur le document.

A3



L01849

297x420mm 1



A4



L01850

210x297mm 3



A5



L01851

148x210mm 3



PHOTO



L01852

150x148mm 3





SELLOS ACRÍLICOS

—
ACRYLIC STAMPS

—
TAMPONS ACRYLIQUES

BLOQUES ACRÍLICOS · ACRYLIC BLOCK · BLOC ACRYLIQUE

Bloque acrílico con mango intercambiable

—
Acrylic block with interchangeable grip

—
Bloc acrylique avec manche interchangeable

Set 3 bloques acrílicos con mango intercambiable

—
Kit 3 acrylic block with interchangeable grip

—
Kit 3 bloc acrylique avec manche interchangeable



17300
6x10cm
🛒 5



17301
10x15cm
🛒 5



17302
5x5cm · 6x10cm · 10x15cm
🛒 3

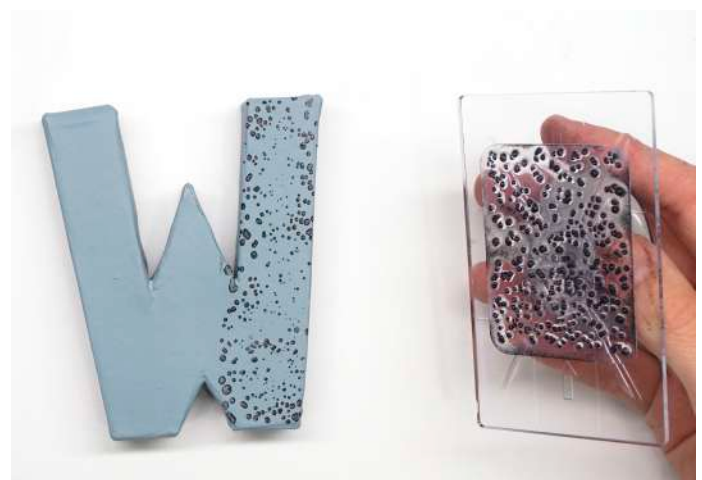

El bloque acrílico al ser transparente facilita la visualización del estampado. Gracias al “asa” podremos hacer una presión uniforme.

—
The transparency of the acrylic block allows seeing the stamping and thanks to the holder, we can press evenly.

—
Le bloque acrylique, comme il est transparent, il facilite la visualisation de l'estampage et, grâce au manche, on peut faire une pression uniforme.



SELLOS ACRÍLICOS · ACRYLIC STAMPS · TAMPONS ACRYLIQUE

Alta calidad. Formas muy definidas que hacen posible una estampación perfecta. Reposicionables, siempre se adhieren. Fáciles de aplicar y almacenar.

High quality. Well defined shapes that allow perfect stamping. Repositionable, they always stick. Easy to use and store.

Haute qualité. Formes très définies qui font possible un estampage parfait. Repositionnables, ils se collent toujours. Faciles à appliquer et à ranger.



Packaging en forma de carpeta que facilita su almacenamiento.

Folder shape package, easy to open and store.

Package en forme de pochette, facile à ouvrir et à ranger.

ABECEDARIOS · ALPHABET · ALPHABET

14x18cm 1



17337



17338



17339

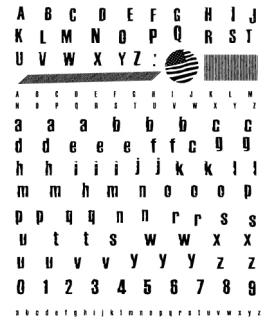

17340

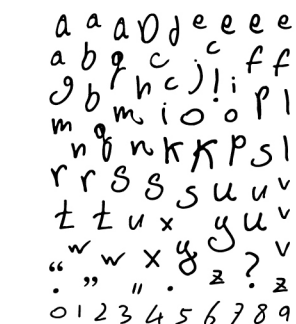

17341



COSTURA · SEWING · COUTURE

14x18cm 1



17358



17359



VIAJE · TRAVEL · VOYAGE



17320
9,5x14,5cm



17321
9,5x14,5cm



17330
14x18cm



17333
14x18cm

FIESTA · PARTY · FÊTE

AMOR · LOVE · AMOUR



17334
14x18cm



17303
5,3x6cm



17336
14x18cm



17352
14x18cm

FLORES Y PLANTAS · FLOWERS AND PLANTS · FLEURS ET PLANTES



17316
5,3x6cm



17326
9,5x14,5cm



17353
14x18cm



17354
14x18cm





ANIMALES · ANIMALS · ANIMAUX

14x18cm 1

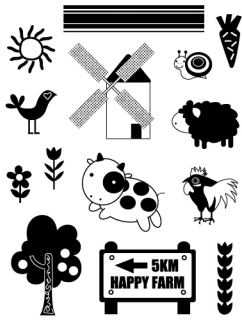

17357



17364

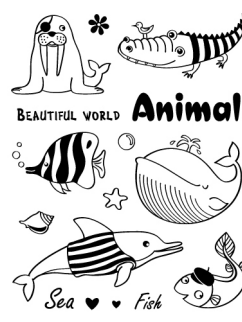

17365



17366

COMIDA · FOOD · ALIMENTS

14x18cm 1



17367

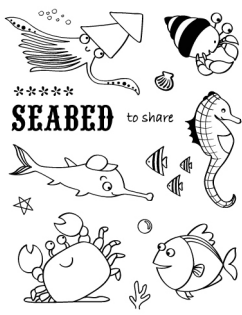

17368



17331



17332

ETIQUETAS Y MARCOS · LABELS AND FRAMES · LABELS ET CADRES

14x18cm 1



17346



17347

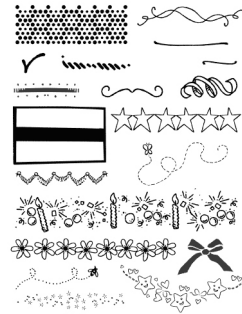

17348

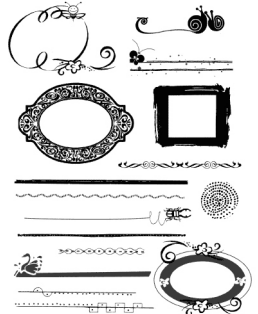

17349

BEBÉ · BABY · BÉBÉ

1

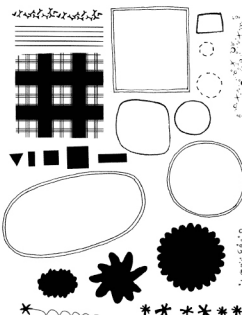

17350



17325

9,5x14,5cm



17342

14x18cm



17343

14x18cm



ESTACIÓN DEL AÑO · SEASONS · SAISON DE L'ANNÉE

14x18cm 1



17360



17361



17362



17363

NAVIDAD · CHRISTMAS · NOËL

1



17322

9,5x14,5cm



17323

9,5x14,5cm



17324

9,5x14,5cm



17335

14x18cm

TEXTURAS · TEXTURES · TEXTURES

9,5x14,5cm 1

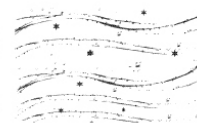
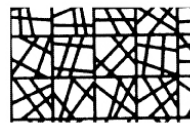
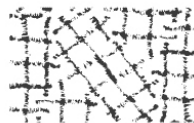
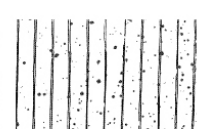
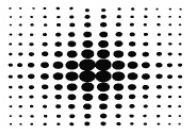
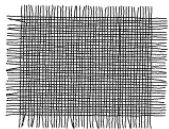

17317

17318

17319

NIÑOS Y NIÑAS · BOYS AND GIRLS · GARÇONS ET FILLES

14x18cm 1



17344



17345

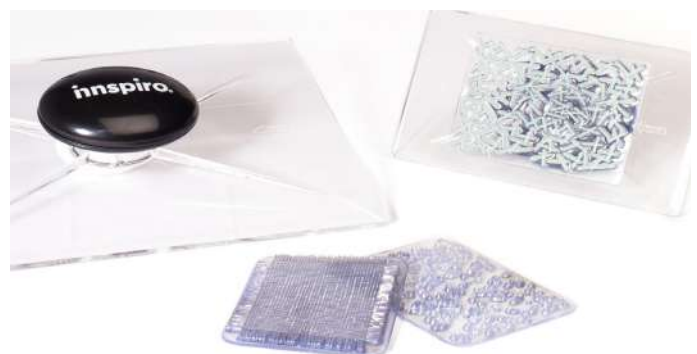



DECORACIÓN · DECOR · DECORATION

14x18cm 1



17327

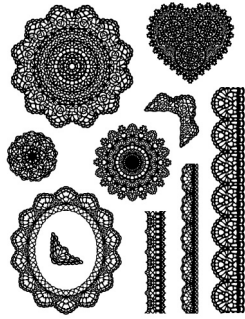

17328



17329

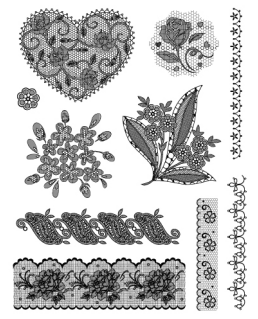

17351

CACHEMIR · CASHMERE · CACHEMIRE

14x18cm 1



17355



17356





5,3x6cm  3



17304



17305



17306



17307



17308



17309



17310



17311



17312



17313



17314



17315







STAZON PIGMENT

Almohadilla tinta opaca
Opac ink pad
Éponge d'encre opaque



TSZ-PIG-...

76x35mm



La tinta especial StazOn Pigment es una tinta con una gran versatilidad y resistencia. Ideal para todo tipo de superficies como plástico, metal, cristal, cerámica, celofán, papel aluminio o metalizado, fotografías, piel y acrílicos, etc. Libre de ácido, esto significa que no dañará nuestros trabajos en papel ni tampoco nuestras fotografías. No hace falta fijarla. Su alta definición y opacidad permitirá realizar un estampado perfecto. Se puede utilizar con todo tipo de sellos acrílicos, de caucho o de goma. Su almohadilla está hecha de fieltro para que la tinta penetre bien en el sello y no se seque con el tiempo.

The special StazOn Pigment ink is an ink with great versatility and strength. It is ideal for all types of surfaces such as plastic, metal, glass, ceramics, cellophane, aluminium or metallic paper, photographs, leather and acrylics, etc. Acid free, this means that it will not damage our paper work or our photographs. No need to fix it. Its high definition and opacity will allow a perfect print. It can be used with all types of acrylic, rubber or rubber stamps. Its pad is made of felt so that the ink penetrates well into the stamp and does not dry out over time.

L'encre spéciale StazOn Pigment est une encre très versatile et résistante. Parfaite pour tout genre de surfaces comme le plastique, le métal, cristal, céramique, cellophane, papier d'aluminium ou métallisé, photographies, cuir et acryliques, etc. Libre en acide, ce qui signifie que votre travail ne sera pas endommagé ni pour le papier ni pour les photographies. Il n'est pas nécessaire de fixer. Son haute définition et opacité permet de pouvoir réaliser un estampillé parfait. Peut s'utiliser avec tout genre de tampons acryliques, en liège ou en gomme. Son coussinet est fait en feutre de laine afin que l'encre puisse bien pénétrer le tampon sans se sécher avec le temps.



TINTA DISOLVENTE
SOLVENT INK
ENCRE DILUANT

SECADO RÁPIDO
QUICK DRY
SÉCHAGE RAPIDE

SECADO AIRE
AIR INK
SÉCHAGE AIR

OPACA
OPAQUE
OPAQUE



TSZ-PIG-001
SNOWFLAKE



TSZ-PIG-011
GRAPE CANDY



TSZ-PIG-021
PASSION RED



TSZ-PIG-031
PIANO BLACK



TSZ-PIG-032
KOALA GREY



TSZ-PIG-041
CHOCOLATE BROWN



TSZ-PIG-051
SHAMROCK GREEN



TSZ-PIG-061
MARINER BLUE



TSZ-PIG-062
PEACOCK FEATHERS



TSZ-PIG-071
ORANGE PEEL



TSZ-PIG-081
PINK COSMOS



TSZ-PIG-091
LEMON DROP



EXPOSITOR · DISPLAY · PRESENTOIR



CONTENIDO · CONTENT · CONTENU

12 COLORES
COLOURS
COULEURS

TSZ-PIG-...
001/011/021/031/032/041
051/061/062/071/081/091

6 UNIDADES POR COLOR
UNITÉS POR COULEUR
UNITS PER COLOUR



42,5x38,5x20,5cm

DIS715



STAZON

La almohadilla original de tinta disolvente multisuperficies.

The original dry solvent ink pad for every surface.

L'originale éponge d'encre diluant pour toutes les surfaces.



TSZ-...

95x65mm

6



TRZ-...

Refill

15ml

3



TINTA DISOLVENTE
SOLVENT INK
ENCRE DILUANT

SECADO RÁPIDO
QUICK DRY
SÉCHAGE RAPIDE

SECADO AIRE
AIR INK
SÉCHAGE AIR

TRANSLÚCIDA
TRANSLUCENT
TRANSLUCIDE

APLICACIÓN: Plástico, metal, plástico shrink, caucho, cuero, arcilla polimérica, papel plastificado, papel liso, papel texturizado, papel foto, vidrio, porcelana, terracota, celofán.

APPLICATION: Plastic, metal, shrink plastic, rubber, leather, polymer clay, laminated paper, coated paper, uncoated paper, photo, glass, porcelain, terracotta, cellophane.

APPLICATION: Plastique, metal, plastique fou, papier lisse, papier texturé, papier photo, verre, porcelaine, terre cuite, cellophane.

 TSZ-11 TRZ-11 Iris	 TSZ-12 TRZ-12 Vibrant violet	 TSZ-21 TRZ-21 Blazing red	 TSZ-22 TRZ-22 Black cherry
 TSZ-31 TRZ-31 Jet Black	 TSZ-32 TRZ-32 Stone Gray	 TSZ-33 TRZ-33 Dove Gray	 TSZ-41 TRZ-41 Timber Brown
 TSZ-42 TRZ-42 Rusty Brown	 TSZ-43 TRZ-43 Saddle Brown	 TSZ-51 TRZ-51 Olive green	 TSZ-52 TRZ-52 Cactus Green
 TSZ-53 TRZ-53 Eden Green	 TSZ-61 TRZ-61 Ultramarine	 TSZ-62 TRZ-62 Midnight Blue	 TSZ-63 TRZ-63 Teal Blue
 TSZ-64 TRZ-64 Hydrangea Blue	 TSZ-81 TRZ-81 Cherry Pink	 TSZ-82 TRZ-82 Fuchsia Pink	 TSZ-91 TRZ-91 Mustard
 TSZ-92 TRZ-92 Pumpkin	 TSZ-93 TRZ-93 Sunflower yellow	 TSZ-95 TRZ-95 Azure	 TSZ-99 TRZ-99 Forest Green
 TSZ-101 TRZ-101 Royal Purple			



Uso con esponja
Use with sponge
Usage avec éponge



Aplicación con sellos
Application with stamps
Application avec tampons



Aplicación con Fantastix
Application with Fantastix pen
Application avec Fantastix



El tiempo de secado es de 3 segundos (superficies porosas), 5 minutos (superficies no porosas). Varía según el material, humedad, etc...

The drying time is 3 seconds (porous surfaces) - 5 minutes (non porous surfaces). Varies based on surface / material, humidity, etc...

Le temps de séchage est de 3 secondes, (superficie poreuse), 5 minutes (superficie non poreuse). Varie en fonction du matériel, de l'humidité, etc...

EXPOSITOR · DISPLAY · PRESENTOIR

1

CONTENIDO · CONTENT · CONTENU

12 COLORES
COLOURS
COULEURS
TSZ-...
11/21/31/32/42/43
51/62/81/82/99/101

6 UNIDADES POR COLOR
UNITÉS POR COULEUR
UNITS PER COULEUR



42,5x38,5x20,5cm

DIS701-A



STAZON MIDI

La almohadilla original de tinta disolvente multisuperficies en pequeño formato.
The original dry solvent ink pad for every surface in a small format.
L'originale éponge d'encre diluante pour toutes les surfaces en petit format.



TSZ-MID-...

58x58mm

3



TRZ-...

Refill

15ml

3



TINTA DISOLVENTE
SOLVENT INK
ENCRE DILUANT

SECADO RÁPIDO
QUICK DRY
SÉCHAGE RAPIDE

SECADO AIRE
AIR INK
SÉCHAGE AIR

TRANSLÚCIDA
TRANSLUCENT
TRANSLUCIDE



APLICACIÓN: Plástico, metal, plástico shrink, caucho, cuero, arcilla polimérica, papel plastificado, papel liso, papel texturizado, papel foto, vidrio, porcelana, terracota, celofán.

APPLICATION: Plastic, metal, shrink plastic, rubber, leather, polymer clay, laminated paper, coated paper, uncoated paper, photo, glass, porcelain, terracotta, cellophan.

APPLICATION: Plastique, metal, plastique fou, papier lisse, papier texturé, papier photo, verre, porcelaine, terre cuite, cellophane.

EXPOSITOR · DISPLAY · PRESENTOIR

1



CONTENIDO
CONTENT
CONTENU

9 COLORES
COLOURS
COULEURS

TSZ-MID-...
12/13/23/31/45
51/54/71/81

6 UNIDADES POR COLOR
UNITÉS POR COULEUR
UNITS PER COLOUR

22,5x38,5x20,5cm

DIS751





STAZON METALLIC

La almohadilla original de tinta disolvente multisuperficies.

The original dry solvent ink pad for every surface.

L'originale éponge d'encre diluant pour toutes les surfaces.



TSZ-...

50gr



TRZ-...



Refill

15ml



TINTA DISOLVENTE
SOLVENT INK
ENCRE DILUANT

SECADO RÁPIDO
QUICK DRY
SÉCHAGE RAPIDE

SECADO AIRE
AIR INK
SÉCHAGE AIR

TRANSLÚCIDA
TRANSLUCENT
TRANSLUCIDE



TSZ-191
Gold



TRZ-191



TSZ-192
Silver



TRZ-192



TSZ-193
Copper



TRZ-193



TSZ-195
Platinum



TRZ-195

APLICACIÓN: Plástico, metal, plástico shrink, caucho, cuero, arcilla polimérica, papel plastificado, papel liso, papel texturizado, papel foto, vidrio, porcelana, terracota, celofán.

APPLICATION: Plastic, metal, shrink plastic, rubber, leather, polymer clay, laminated paper, coated paper, uncoated paper, photo, glass, porcelain, terracotta, cellophan.

APPLICATION: Plastique, metal, plastique fou, papier lisse, papier texturé, papier photo, verre, porcelaine, terre cuite, cellophane.



Agitar bien antes de usar la tinta. Deje caer 5 ó 8 gotas de tinta sobre la almohadilla. Utilice la mini paletina de goma incluida para esparcir la tinta de manera uniforme sobre la almohadilla.

Shake ink well before use. Apply 5 to 8 drops of ink onto the pad. Use the included mini squeegee to spread the ink evenly over the pad.

Bien agiter avant d'utiliser l'encre. Mettre 5 ou 8 gouttes d'encre sur l'éponge. Utiliser la mini palette en gomme inclus pour répandre l'encre d'une façon uniforme sur l'éponge.



Agitar bien la tinta antes de usar. Aplicar cuidadosamente los sellos entintados en superficies no porosas. Las imágenes se pueden borrar de algunas superficies no porosas con el limpiador StazOn.

Limpie los sellos inmediatamente después de su uso con el limpiador StazOn y pruebe antes de usar.

La opacidad se puede ver afectada por la superficie de sellado (la tinta es más opaca sobre superficies no porosas.) Vuelva a colocar la cubierta interior de plástico y tape inmediatamente después de su uso. La exposición al aire hará que la tinta en la almohadilla se seque.



El tiempo de secado es de 3 segundos (superficies porosas) y 5 minutos (superficies no porosas). Varía según el material, humedad, etc...

Shake ink well before use. Carefully apply inked stamps to non-porous surfaces. Images may be able to be erased from some non-porous surfaces with StazOn Cleaner. Clean stamps immediately after use with StazOn Cleaner. StazOn Metallic may be transformed clear stamps. Test before using. Opacity may be affected by stamped surface (ink is more opaque on non-porous surfaces.) Replace inner plastic cover and cover immediately after use. Exposure to air will cause the ink in the pad to dry out.

The drying time is 3 seconds (porous surfaces) - 5 minutes (non porous surfaces). Varies based on surface / material, humidity, etc...

Bien remuer avant d'utiliser l'encreur. Appliquer avec précaution les tampons encrés sur les surfaces non poreuses. Les images peuvent être effacées d'une surface non poreuse avec l'effaceur Stazon. Nettoyer de suite les tampons après leur utilisation avec l'effaceur Stazon et faire un essai avant l'utilisation. L'opacité peut variée dépendant de la surface choisie (l'encre est plus opaque sur une surface non poreuse). L'exposition à l'air fera que l'encre de l'éponge se sèche.

Le temps de séchage est de 3 secondes (superficie poreuse) et 5 minutes (superficie non poreuse). Varie en fonction du matériel, de l'humidité, etc...



STAZON OPAQUE

La almohadilla original de tinta disolvente multisuperficies.

The original dry solvent ink pad for every surface.

L'originale éponge d'encre diluant pour toutes les surfaces.



TSZ-...

50gr



1

TRZ-...



Refill

15ml



1



TINTA DISOLVENTE
SOLVENT INK
ENCRE DILUANT

SECADO RÁPIDO
QUICK DRY
SÉCHAGE RAPIDE

SECADO AIRE
AIR INK
SÉCHAGE AIR

TRANSLÚCIDA
TRANSLUCENT
TRANSLUCIDE



TSZ-105 TRZ-105
Butter Cream



TSZ-106 TRZ-106
Blush Pink



TSZ-107 TRZ-107
Soft Lilac



TSZ-108 TRZ-108
Baby Blue



TSZ-109 TRZ-109
Mellow Mint



TSZ-110 TRZ-110
Cotton White



TSZ-111 TRZ-111
Napoli Yellow



TSZ-140 TRZ-140
Fava Green

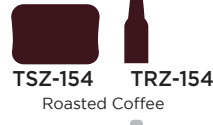

TSZ-154 TRZ-154
Roasted Coffee



TSZ-156 TRZ-156
Bordeaux



TSZ-158 TRZ-158
Abyssal Blue



TSZ-161 TRZ-161
Cypress Green



TSZ-181 TRZ-181
Mist Gray

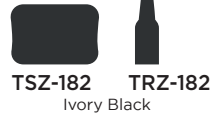

TSZ-182 TRZ-182
Ivory Black

APLICACIÓN: Plástico, metal, plástico shrink, caucho, cuero, arcilla polimérica, papel plastificado, papel liso, papel texturizado, papel foto, vidrio, porcelana, terracota, celofán.

APPLICATION: Plastic, metal, shrink plastic, rubber, leather, polymer clay, laminated paper, coated paper, uncoated paper, photo, glass, porcelain, terracotta, cellophane.

APPLICATION: Plastique, metal, plastique fou, papier lisse, papier texturé, papier photo, verre, porcelaine, terre cuite, cellophane.



Agitar bien antes de usar la tinta. Deje caer 5 ó 8 gotas de tinta sobre la almohadilla. Utilice la mini paletina de goma incluida para esparcir la tinta de manera uniforme sobre la almohadilla.

Shake ink well before use. Apply 5 to 8 drops of ink onto the pad. Use the included mini squeegee to spread the ink evenly over the pad.

Bien agiter avant d'utiliser l'encre. Mettre 5 ou 8 gouttes d'encre sur l'éponge. Utiliser la mini palette en gomme inclus pour répandre l'encre d'une façon uniforme sur l'éponge.



Aplicar cuidadosamente los sellos entintados en superficies no porosas. Las imágenes se pueden borrar de algunas superficies no porosas con el limpiador StazOn. Limpie los sellos inmediatamente después de su uso con el limpiador StazOn.

Pruebe antes de usar. La opacidad se puede ver afectada por la superficie de sellado (la tinta es más opaca sobre superficies no porosas.) Vuelva a colocar la cubierta interior de plástico y tape inmediatamente después de su uso.

La exposición al aire hará que la tinta en la almohadilla se seque.



El tiempo de secado es de 3 segundos (superficies porosas) y 5 minutos (superficies no porosas). Varía según el material, humedad, etc...

The drying time is 3 seconds (porous surfaces) - 5 minutes (non porous surfaces). Varies based on surface / material, humidity, etc...

Le temps de séchage est de 3 secondes (surface poreuse) et 5 minutes (surface non poreuse). Varie en fonction du matériel, de l'humidité, etc...

Carefully apply inked stamps to non-porous surfaces. Images may be able to be erased from some non-porous surfaces with StazOn Cleaner. Clean stamps immediately after use with StazOn Cleaner. StazOn Metallic may be transformed clear stamps. Test before using. Opacity may be affected by stamped surface (ink is more opaque on non-porous surfaces). Replace inner plastic cover and cover immediately after use. Exposure to air will cause the ink in the pad to dry out.

Appliquer avec précaution les tampons encrés sur les surfaces non poreuses. Les images peuvent être effacées d'une surface non poreuse avec l'effaceur Stazon. Nettoyer de suite les tampons après leur utilisation avec l'effaceur Stazon. Faire un essai avant l'utilisation. L'opacité peut varieré dépendant de la surface choisie (l'encre est plus opaque sur une surface non poreuse). L'exposition à l'environnement fera que l'encre de l'éponge se sèche.





STAZON STUDIO GLAZE

Tinta ideal para crear efecto vital.
Ideal ink to create stained glass effects.
Encre idéal pour créer des effets de vitraux.



TSZ-STG-...

25ml

3



TINTA PIGMENTO
PIGMENT INK
ENCRE PIGMENT

TINTA BASE AGUA
WATER BASED
À BASE D'EAU

SECADO AIRE
AIR INK
SÉCHAGE AIR

MULTI-SUPERFICIES
EVERY SURFACE
TOUTES LES SURFACES



TSZ-STG-110
Cotton white



TSZ-STG-13
Gothic purple



TSZ-STG-191
Gold



TSZ-STG-192
Silver



TSZ-STG-23
Claret



TSZ-STG-24
St Valentine



TSZ-STG-31
Jey black



TSZ-STG-34
Cloudy sky



TSZ-STG-44
Ganache



TSZ-STG-45
Spiced chai



TSZ-STG-52
Cactus green



TSZ-STG-54
Emerald city



TSZ-STG-62
Midnight blue



TSZ-STG-65
Blue Hawaii



TSZ-STG-71
Orange Zest

APLICACIÓN: Apta para vidrio, acrílico, metal, papel, madera y otras superficies no porosas.

APPLICATION: Works on glass, acrylic, metal, paper, wood and other non-porous surfaces.

APPLICATION: Apte pour verre, acrylique, métal, papier, bois, et d'autres surfaces non poreuses.



Aplicar directamente del bote para realizar trazados o un dibujo dimensional a mano alzada.

Apply directly from the bottle to trace or free-hand draw a dimensional image.

Appliquer directement de la bouteille pour réaliser des tracés ou un dessin à main levée.



No se requiere cocción. Se puede combinar con StazOn Midi y StazOn Metallic "oro" / "plata" y StazOn Opaque "Cotton white".

Does not require oven baking. Can match it with the StazOn Midi line along with StazOn Metallic Gold / Silver and StazOn Opaque Cotton White.

Il ne faut pas de cuisson au four. Combinables avec la ligne d'encres StazOn Midi, StazOn Metallic couleurs «or» / «argent» et StazOn Opaque «cotton white».



Aplicación con plantillas directo del bote gracias a la cánula de precisión.

Application with stencils directly from the bottle thanks to its precision nozzle.

Application au pochoir directement de la bouteille grâce à la canule de précision.

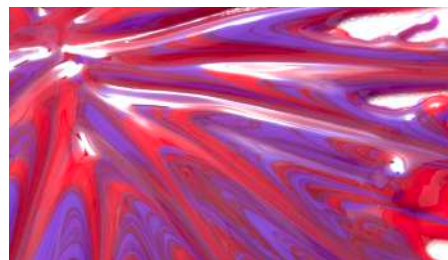

Se pueden mezclar los colores entre sí para crear un efecto de marmoleado.

Colors can be partially or totally mixed in order to create a marble effect.

On peut mélanger les couleurs partiellement ou totalement pour créer un effet marbre.



Uso acuarelado, aplicando con un pincel.

Dilute it with water to apply it with a paint brush.

Diluez-le dans de l'eau pour l'appliquer avec un pinceau.



MEMENTO

Tinta de color brillante y transparente.

Transparent and brilliant sparkling Ink.

Encre de couleur brillante et transparente.



TME-...

95x65mm

6



TMD-...

32x50mm

6



TRM-...

Refill

15ml

3



TINTA BASE AGUA
WATER BASED INK
ENCRE BASE EAU

SECADO RÁPIDO
QUICK DRY
SÉCHAGE RAPIDE

TRANSLÚCIDA
TRANSLUCENT
TRANSLUCIDE

APLICACIÓN: Papel liso, papel vegetal, papel texturizado, papel impreso.

APPLICATION: Papier lisse, parchemin, papier texturé, papier imprimé.

APPLICATION: Papier lisse, parchemin, papier texturé, papier imprimé.



El tiempo de secado es de 3 a 5 segundos sobre papel texturizado. Prácticamente instantáneo sobre papel liso. Varía según el material, humedad, etc...

The drying time is 3 to 5 seconds on coated paper. Virtually instant on uncoated papers. Varies based on surface / material, humidity, etc...

Le temps de séchage est de 3 à 5 secondes sur papier couché. Virtuellement instantané sur papier non couché. Varie en fonction du matériel, de l'humidité, etc...

			TME-100	TMD-100	TRM-100	Dandelion
			TME-103	TMD-103	TRM-103	Cantaloupe
			TME-200	TMD-200	TRM-200	Tangelo
			TME-201	TMD-201	TRM-201	Morocco
			TME-300	TMD-300	TRM-300	Lady Bug
			TME-301	TMD-301	TRM-301	Rhubarb Stalk
			TME-302	TMD-302	TRM-302	Love letter
			TME-400	TMD-400	TRM-400	Rose Bud
			TME-404	TMD-404	TRM-404	Angel Pink
			TME-500	TMD-500	TRM-500	Grape Jelly
			TME-501	TMD-501	TRM-501	Lilac Posies
			TME-504	TMD-504	TRM-504	Lulu
			TME-506	TMD-506	TRM-506	lavenderSweet Plum
			TME-507	TMD-507	TRM-507	Elderberry
			TME-600	TMD-600	TRM-600	Danube Blue
			TME-601	TMD-601	TRM-601	Bahama Blue
			TME-602	TMD-602	TRM-602	Teal Zeal
			TME-604	TMD-604	TRM-604	Summer Sky
			TME-607	TMD-607	TRM-607	Nautical Blue
			TME-608	TMD-608	TRM-608	Paris Dusk
			TME-701	TMD-701	TRM-701	Cottage Ivy
			TME-703	TMD-703	TRM-703	Pear Tart
			TME-704	TMD-704	TRM-704	New Sprout
			TME-706	TMD-706	TRM-706	Pistachio
			TME-707	TMD-707	TRM-707	Bamboo Leaves
			TME-708	TMD-708	TRM-708	Olive Grove
			TME-709	TMD-709	TRM-709	Northern Pine
			TME-800	TMD-800	TRM-800	Rich Cocoa
			TME-801	TMD-801	TRM-801	Potter's Clay
			TME-802	TMD-802	TRM-802	Peanut Brittle
			TME-804	TMD-804	TRM-804	Desert Sand
			TME-805	TMD-805	TRM-805	Toffee Crunch
			TME-808	TMD-808	TRM-808	Espresso Truffle
			TME-900	TMD-900	TRM-900	Tuxedo Black
			TME-901	TMD-901	TRM-901	London Fog
			TME-902	TMD-902	TRM-902	Gray Flannel

EXPOSITOR · DISPLAY · PRESENTOIR

1



42,5x38,5x20,5cm

DIS702-A

CONTENIDO
CONTENT
CONTENU

12 COLORES
COLOURS
COULEURS
6 UNIDADES POR COLOR
UNITS PER COULEUR
UNITS PER COLOUR

TME-...
300/103/404/504/507/604
704/707/800/802/900/808



22,5x38,5x20,5cm

DIS761

CONTENIDO
CONTENT
CONTENU

18 COLORES
COLOURS
COULEURS
6 UNIDADES POR COLOR
UNITS PER COULEUR
UNITS PER COLOUR

TMD-...
100/201/300/400/404/501
504/601/607/701/703/706
708/801/802/808/900/901



MEMENTO

Draw Drop Sets



TMD-100-...

32x50mm



TMD-012-...

32x50mm



TMD-100-001 Campfire 300 200 103 100	TMD-100-002 Greenhouse 701 707 703 704	TMD-100-003 Juicy purples 500 501 506 504	TMD-012-100 Gum drops 300 200 103 100 703 701 601 600 501 500 800 900
TMD-100-004 Tinta ocean 600 608 601 604	TMD-100-005 Arizona canyons 800 301 801 804	TMD-100-006 Girl's night out 400 404 901 900	
TMD-100-007 Meadowland 801 707 301 200	TMD-100-008 Jelly beans 200 707 900 500	TMD-100-009 Gotta have 900 300 701 800	TMD-012-200 Sorbet scoops 301 400 404 506 504 604 608 707 704 804 801 901
TMD-100-010 Stone mountain 900 901 800 804	TMD-100-011 Prime time 600 701 300 100	TMD-100-012 Beach party 400 703 601 100	
TMD-100-013 Farmer's market 103 506 703 301	TMD-100-014 Oh baby! 604 504 704 404	TMD-100-015 Rainy daze 500 501 600 901	TMD-012-300 Snow cones 805 201 302 802 706 708 709 808 507 602 607 902
TMD-100-016 Golden sunset 805 201 302 802	TMD-100-017 Central park 706 708 709 808	TMD-100-018 Dolphin play 507 602 607 902	



Aplicación directa al sello.
Direct application to stamp.
Application directe sur le tampon.



Aplicación emboss frío.
Application cold emboss.
Application emboss froid.



Estampación.
Stamping.
Tamponer.



MEMENTO

Rotulador DUAL: Punta pincel - Punta escritura

Dual pen: Tip Brush - Tip writing

Feutre dual: pointe de brosse - pointe d'écriture



TPM...

6

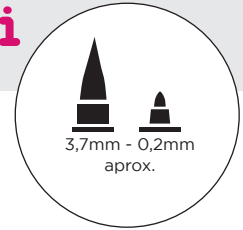

TINTA BASE AGUA
WATER BASED INK
ENCRE BASE EAU

SECADO RÁPIDO
QUICK DRY
SÉCHAGE RAPIDE

TRANSLÚCIDA
TRANSLUCENT
TRANSLUCIDE

APLICACIÓN: Papel liso, papel vegetal, papel texturizado, papel impreso.

APPLICATION: Papier lisse, parchemin, papier texturé, papier imprimé.

APPLICATION: Papier lisse, parchemin, papier texturé, papier imprimé.



TPM-100
Dandelion



TPM-103
Cantaloupe



TPM-200
Tangelo



TPM-201
Morocco



TPM-300
Lady Bug

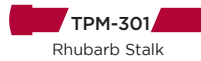

TPM-301
Rhubarb Stalk



TPM-302
Love letter



TPM-400
Rose Bud



TPM-404
Angel Pink



TPM-500
Grape Jelly



TPM-501
Lilac Posies



TPM-504
Lulu lavender



TPM-506
Sweet Plum

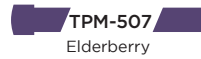

TPM-507
Elderberry



TPM-600
Danube Blue



TPM-601
Bahama Blue



TPM-602
Teal Zeal



TPM-604
Summer Sky



TPM-607
Nautical Blue

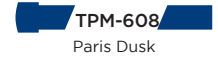

TPM-608
Paris Dusk



TPM-701
Cottage Ivy

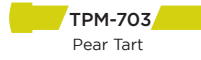

TPM-703
Pear Tart



TPM-704
New Sprout



TPM-706
Pistachio



TPM-707
Bamboo Leaves



TPM-708
Olive Grove



TPM-709
Northern Pine



TPM-800
Rich Cocoa



TPM-801
Potter's Clay

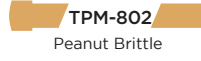

TPM-802
Peanut Brittle



TPM-804
Desert Sand

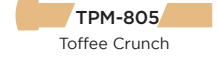

TPM-805
Toffee Crunch

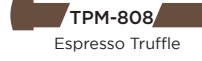

TPM-808
Espresso Truffle



TPM-900
Tuxedo Black



TPM-901
London Fog



TPM-902
Gray Flannel

MEMENTO (solo contenido)

MEMENTO MARKER RANGE (Contents only)

GAMME FEUTRES MEMENTO (Seulement le contenu)

89310
24 COLORES
COLOURS
COULEURS

6 UNIDADES POR COLOR
UNITÉS POR COULEUR
UNITS PER COLOUR

89320
*NO PHOTO

12 COLORES
COLOURS
COULEURS

6 UNIDADES POR COLOR
UNITÉS POR COULEUR
UNITS PER COLOUR





MEMENTO

Set rotulador dual

Dual pen memento sets

Set feutres dual memento



TPM-100-...



TPM-100-001 Camp Fire



TPM-100-002 Greenhouse

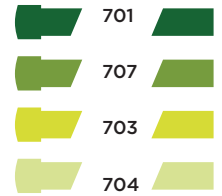

TPM-100-003 Juicy Purples

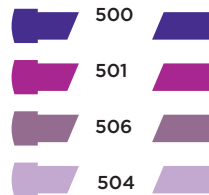

TPM-100-004 Ocean

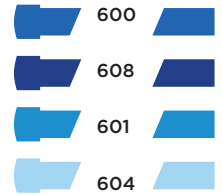

TPM-100-005 Arizona Canyons

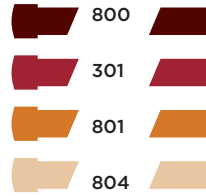

TPM-100-006 Girls'Night Out

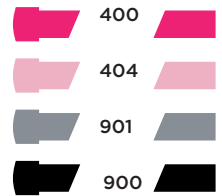

Pintar, ilustrar y lettering.
Paint, illustrate and lettering.
Dessiner, peindre et lettering.



Estampar varios colores con sellos.
Stamping various colors with stamps.
Tamponner plusieurs couleurs avec tampons.



MEMENTO DE LUXE

Tinta opaca técnicas mixtas
Mix Media opac ink
Encre opaque techniques mixtes



TML-...

96x63mm



6



TRL-...

Refill
15ml



3



TINTA BASE AGUA
WATER BASED INK
ENCRE BASE EAU

TINTA OPACA
OPAC
OPAQUE

PERMITE REPUJADO
SUITABLE FOR EMBOSS
PERMET EMBOSSER

APLICACIÓN: Papel liso, papel vegetal, papel texturizado, papel impreso.

APPLICATION: Papier lisse, parchemin, papier texturé, papier imprimé.

APPLICATION: Papier lisse, parchemin, papier texturé, papier imprimé.

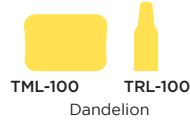

TML-100 TRL-100
Dandelion



TML-201 TRL-201
Morocco

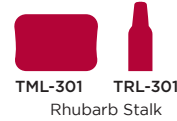

TML-301 TRL-301
Rhubarb Stalk



TML-302 TRL-302
Love Letter

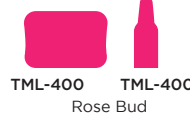

TML-400 TRL-400
Rose Bud



TML-404 TRL-404
Angel Pink



TML-501 TRL-501
Lilac Posies



TML-506 TRL-506
Sweet Plum



TML-507 TRL-507
Elderberry



TML-600 TRL-600
Danube Blue



TML-601 TRL-601
Bahama Blue



TML-602 TRL-602
Teal Zeal



TML-607 TRL-607
Nautical Blue



TML-703 TRL-703
Pear Tart



TML-706 TRL-706
Pistachio

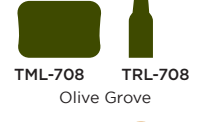

TML-708 TRL-708
Olive Grove

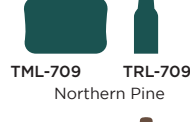

TML-709 TRL-709
Northern Pine

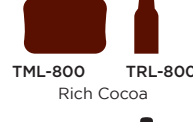

TML-800 TRL-800
Rich Cocoa

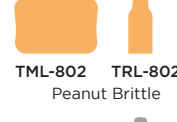

TML-802 TRL-802
Peanut Brittle

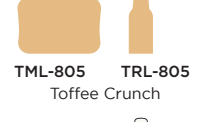

TML-805 TRL-805
Toffee Crunch

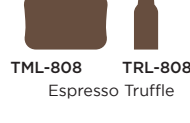

TML-808 TRL-808
Espresso Truffle



TML-900 TRL-900
Tuxedo Black



TML-902 TRL-902
Gray Flannel



TML-910 TRL-910
Wedding Dress



De secado relativamente rápido, tratándose de una tinta de pigmento. Muy resistente a la decoloración.

Relatively fast drying for a pigment ink and highly fade resistant.

Séchage relativement rapide, même étant une encre de pigment. Très résistante à la décoloration.



Estampación sobre madera.
Stamp on wood.
Tamponer sur bois.



Estampación en cuero.
Stamp on leather.
Tamponer sur cuir.



Estampación en textiles, fijación plancha 5 minutos.
Stamp on fabric, iron fixation 5 min.
Tampons on fabric, fixation au fer 5min.

EXPOSITOR · DISPLAY · PRESENTOIRS



1

CONTENIDO · CONTENT · CONTENU

12 COLORES
COLOURS
COULEURS

TML-...
100/201/302/506/601/607
703/708/805/808/900/910

6 UNIDADES POR COLOR
UNITÉS POR COULEUR
UNITS PER COLOUR



42,5x38,5x20,5cm

DIS703-A



RADIANT NEON

Atractiva tinta de pigmentos radiantes.

Luscious pigment ink with eye-popping color.

Attrayant encre de pigment en couleurs radiants.



TNR-...

96x63mm

6



TRN-...

Refill

20ml

3



TINTA BASE AGUA
WATER BASED INK
ENCRE BASE EAU

TINTA OPACA
OPAC
OPAQUE

PERMITE REPUJADO
SUITABLE FOR EMBOSS
PERMET EMBOSSER



TNR-71 TRN-71
Electric Yellow



TNR-72 TRN-72
Electric Orange



TNR-73 TRN-73
Electric Coral



TNR-74 TRN-74
Electric Pink



TNR-75 TRN-75
Electric Purple



TNR-76 TRN-76
Electric Blue



TNR-77 TRN-77
Electric Green



Atractiva tinta de pigmentos con colores llamativos. Disponible en 7 colores dinámicos que resaltan tanto en cartulinas claras como oscuras. Muy resistente a la decoloración.

Luscious pigment ink with eye-popping color. 7 dynamic colors that are striking on both light and dark colored cardstock. Highly fade resistant, blendable archival ink.

Attrayant encre de pigment en couleurs vives. Disponible en 7 couleurs dynamiques qui ressortent sur des bostols clairs et foncés. Très résistante à la décoloration.

SET RADIANT NEON 4

COLORES CÁLIDOS
WARM COLOURS
COULEURS CHAUDES



TNR-QTT-091



Sets de 4 colores eléctricos, fáciles de transportar y almacenar. Resalta tanto en cartulinas claras como oscuras. Muy resistente a la decoloración y fácil de combinar. Ideal para embossing. Se puede utilizar sobre una gran variedad de superficies porosas.

Sets of 4 electric colors for portability and easy storage. Striking on both light and dark colored cardstock. Highly fade resistant, blendable. Great for embossing. May be used on a variety of porous surfaces.

Sets de 4 couleurs électriques faciles à transporter et stocker. Il ressorte sur des bostols clairs et foncés. Hautement résistant à la décoloration et facile à combiner. Idéale pour embosser. On peut l'utiliser sur une grande variété de surfaces non poreuses.



Set dedales esponja 3pc
Set of sponge thimbles 3 pcs
Eponge set 3 dés



TSP-SB

Pincel sintético ECO plano
Flat synthetic brush ECO
Pinceau synthétique éco. plat



T486 - 10

Pincel sintético ECO plano
Round synthetic brush ECO
Pinceau synthétique éco. rond



T485 - 10



Aplicar con esponja.
Apply with a sponge.
Appliquer avec une éponge.



Aplicar en acuarela.
Apply in watercolor.
Appliquer en aquarelle.



NEON AMPLIFY

Tinta de pigmento con base de agua
Water based pigment ink
Encre avec pigment à base d'eau



TNR-AMP-...

25ml

3



TINTA BASE AGUA
WATER BASED INK
ENCRE BASE EAU

TINTA OPACA
OPAC
OPAQUE

REPUJAR
EMBOSS
EMBOSSER

SECADO LENTO
DRY SLOW
SECHAGE LENT



TNR-AMP-71
Amarillo eléctrico



TNR-AMP-72
Naranja eléctrico



TNR-AMP-73
Coral eléctrico



TNR-AMP-74
Rosa eléctrico



TNR-AMP-75
Morado eléctrico



TNR-AMP-76
Azul eléctrico



TNR-AMP-77
Verde eléctrico



TNR-AMP-80
Banco



TNR-AMP-82
Negro



Da vida a los proyectos con un suave y ligero efecto 3D. Colores que combinan con las tintas Radiant Neón. El color blanco puede ser coloreado después del secado, con tintes colorantes. Apto para multisuperficies. Al aplicar calor crearemos un relieve. Resultados impresionantes tanto en papeles claros como oscuros.

Brings project to life with a soft, airy 3D effect. Colors coordinate with Radiant Neon inks. Also available in Black and White. White can be colored after heating with dye inks. Use on a variety of surfaces. Apply directly from the bottle, then use a heat tool to create dimension. Dramatic results on both light and dark papers.

Donne vie aux projets avec un doux et légère effet 3D. Couleurs qui combinent avec les encres Radiant Neon. Aussi disponible en blanc et noir. La couleur blanche peut être colorée après le séchage avec des encres à colorants. On peut l'utiliser sur une grande variété de surfaces. Appliquer directement de la bouteille, après utiliser un outil de chaleur pour créer relief. Résultats impressionnants sur des papiers clairs et foncés.

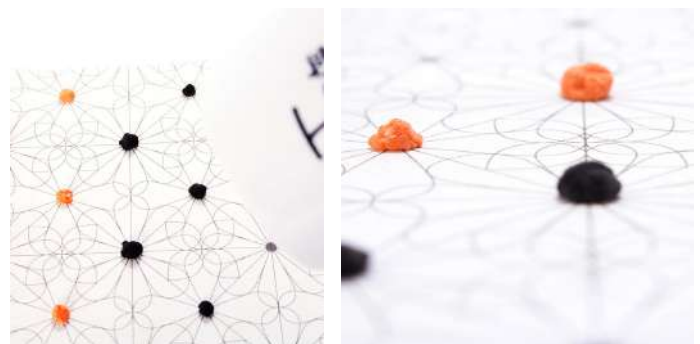

Se puede aplicar directamente del bote y sin aplicar calor, queda un efecto relieve suave y brillante.

It can be applied directly from the bottle with no need to apply heat resulting in a soft and bright relief effect.

On peut l'appliquer directement de la bouteille et, sans appliquer de la chaleur, le résultat est un doux et brillant effet relief.

Para un efecto "amplify" aplicar calor, se volverá mate y con un volumen increíble.

Apply heat for an "amplify" effect, it will turn matte and with a stunning relief.

Pour un effet «amplify», appliquez de la chaleur, il se deviendra mat et avec un incroyable volume.

ENCORE

Colores metálicos brillantes.
Bright metallic colors.
Couleurs métalliques et brillants.



TUM-...

95x65mm

6



TUMR-...

Refill

15ml

3



TINTA BASE ACEITE
OIL BASED INK
ENCRE BASE HUILE

SUPERFICIES POROSAS
POROUS SURFACE
SURFACE POREUSES

SECAJE LENTO
DRY SLOW
SÉCHAGE LENT

REPUJAR
EMBOSS
EMBOSSER



TUM-02



TUMR-02

Pink



TUM-04



TUMR-04

Purple



TUM-06



TUMR-06

Blue



TUM-08



TUMR-08

Green



TUM-14



TUMR-14

Satin Rose



TUM-16



TUMR-16

Teal



TUM-18



TUMR-18

Honeydew



TUM-20



TUMR-20

Champagne



TUM-22



TUMR-22

Copper



TUM-24



TUMR-24

Bronze



APLICACIÓN: Papel liso.

—
APPLICATION: Uncoated paper.

—
APPLICATION: Papier lisse.

Las tintas metálicas Encore proporcionan resultados maravillosos en los papeles claros y oscuros. El color metálico pulido añade un toque de elegancia a la artesanía en papel. El polvo metálico de Encore crea un efecto más “brillante”.

—
Encore metallic inks provide marvelous results on both light and dark papers. Polished metallic colors add an elegant touch to paper crafts. The metallic powder in Encore creates a more “glittery” effect.

—
Les encres métalliques Encore apportent des résultats excellents sur des papiers clairs et sombres. La couleur métallique polie apporte une touche d’élégance concernant le travail sur papier. La poudre métallique de Encore donne un effet plus “brillant”.



El tiempo de secado es de 7 a 10 minutos sobre papel liso. Variará según el material, humedad, etc...

—
The drying time is 7 to 10 minutes on uncoated papers. Varies based on weight / type of paper, humidity, etc.

—
Le temps de séchage es de 7 à 10 minutes sur papier lisse. Varie en fonction du matériel, humidité, etc...

4 colores almohadilla · 4 colors pad · Éponge 4 couleurs



TUM4-02

Sweet Dreams

95x65mm - 50gr 1



Aplicado en papeles oscuros.
Apply on dark papers.
Applée sur papiers sombres.

Aplicado en papeles claros.
Apply on light papers.
Applée sur papiers claires.

Tinta para emboss.
Suitable ink for emboss.
Encre recommande par embosser.



DELICATA

Elegante tinta metálica. No se deslustra ni pierde el brillo.

Exquisite metallic ink. Does not tarnish or lose its luster.

Élégante encre métallique. Elle ne ternit pas ni perd son éclat.



TDE-...

95x65mm

6



TDE-SML...

32x50mm

10



TRC-...

Refill 15ml

3

Oro glitz · Golden glitz · Éclat dorée



TDE-191



TDE-SML-191



TRC-191



TDE-192



TDE-SML-192



TRC-192



TDE-193



TDE-SML-193



TRC-193

Marrón oscuro · Dark brown · Marron foncé



TDE-354



TDE-SML-354



TRC-354



TDE-380



TDE-SML-380



TRC-380



TDE-382



TDE-SML-382



TRC-382

Champan · Champagne · Champagne



TDE-196



TDE-SML-196

Azul zafiro · Sapphire blue · Bleu saphir



TDE-318



TDE-SML-318

Verde esmeralda · Emerald green · Vert émeraude



TDE-321



TDE-SML-321

Rojo rubí · Ruby red · Rouge rubis



TDE-325



TDE-SML-325

Rosa · Pink · Rose



TDE-333



TDE-SML-333

Oro rosado · Rose gold · Or rose



TDE-357



TDE-SML-357

+i La gama Delicata Oro Glitz es de secado más rápido que las tintas metálicas tradicionales.
Delicata Golden Glitz is faster drying than traditional metallic inks.
La gamme Delicata Éclat Dorée est de séchage plus rapide que les encres métalliques traditionnelles.

SETS 4 DELICATA

3



TDE-QTT-001

EXPOSITOR · DISPLAY · PRESENTOIR

1

CONTENIDO
CONTENT
CONTENU

12 COLORES
COLOURS
COULEURS
6 UNIDADES POR COLOR
UNITÉS POR COULEUR
UNITS PER COLOUR

TDE-...
382/380/354/193/192/191
318/196/357/333/325/321

42,5x38,5x20,5cm

DIS705



CONTENIDO
CONTENT
CONTENU

12 COLORES
COLOURS
COULEURS
10 UNIDADES POR COLOR
UNITÉS POR COULEUR
UNITS PER COLOUR

TDE-SML-...
191/192/193/196/318/321
325/333/354/357/380/382

22,5x38,5x20,5cm

DIS771





BRILLANCE

Tinta de pigmento mate, colores perlados y metálicos.
 Pigment ink matt pearl and metallic.
 Encre pigmentmat, couleurs nacrées et métalliques.



TBR-...

95x65mm



6



TBD-...

32x50mm



6



TRB-...

20ml



3



TINTA BASE AGUA
 WATER BASED INK
 ENCRE BASE EAU

TINTA OPACA
 OPAC
 OPAQUE

REPUJAR
 EMBOSS
 EMBOSSE

SECADO LENTO
 DRY SLOW
 SECHAGE LENT

MULTISUPERFICIES
 EVERY SURFACES
 TOUTES SURFACES

APLICACIÓN: Papel liso, papel texturizado, piel, pergamino, papel foto, cuero, celofán, madera natural, pasta polimérica, plástico shrink, terracota.

APPLICATION: Uncoated paper, coated paper, vellum, photo, leather(tanned leather), cellophane, unpainted wood, polymer clay, shrink plastic, terracotta.

APPLICATION: Papier lisse, papier texturé, cuir, parchemin, papier photo, cellophane, bois naturel, pâte polymérique, plastique shrink, terre cuite.



El tiempo de secado es de 10 a 15 minutos sobre papel liso. Se incrementará en papeles texturizados. Variará según el material, humedad, etc.

The drying time is 10 - 15 minutes on uncoated paper. It will increase on coated papers. Varies based on surface / material, humidity, etc.

Temps de séchage de 10 à 15 minutes sur le papier lisse. Il augmentera sur les papiers texturés. Varie en fonction du matériel, de l'humidité, etc.

			TBR-11	TBD-11	TRB-11	Sunflower Yellow				TBR-17	TRB-17	Victorian Violet				TBR-18	TBD-18	TRB-18	Mediterranean Blue				TBR-21	TBD-21	TRB-21	Gamma Green	
			TBR-23	TBD-23	TRB-23	Rocket Red				TBR-30	TRB-30	Pearlescent Yellow				TBR-31	TRB-31	Pearlescent Orange				TBR-32	TRB-32	Pearlescent Coral			
			TBR-34	TBD-34	TRB-34	Pearlescent Orchid				TBR-36	TBD-36	TRB-36	Pearlescent Purple				TBR-37	TBD-37	TRB-37	Pearlescent Lavender				TBR-38	TBD-38	TRB-38	Pearlescent Sky Blue
			TBR-41	TRB-41	Pearlescent Jade				TBR-42	TBD-42	TRB-42	Pearlescent Lime				TBR-53	TBD-53	TRB-53	Pearlescent Olive				TBR-54	TBD-54	TRB-54	Coffee Bean	
			TBR-55	TBD-55	TRB-55	Pearlescent Beige				TBR-61	TBD-61	TRB-61	Pearlescent Rust				TBR-62	TBD-62	TRB-62	Pearlescent Crimson				TBR-63	TRB-63	Pearlescent Poppy	
			TBR-64	TBD-64	TRB-64	Pearlescent Ivy				TBR-74	TRB-74	Pearlescent Ice Blue				TBR-75	TBD-75	TRB-75	Pearlescent Thyme				TBR-76	TBD-76	TRB-76	Pearlescent Chocolate	
			TBR-80	TBD-80	TRB-80	Moonlight White				TBR-82	TBD-82	TRB-82	Graphite Black				TBR-90	TRB-90	Starlite Black				TBR-91	TBD-91	TRB-91	Galaxy Gold	
			TBR-92	TBD-92	TRB-92	Platinum Planet				TBR-93	TBD-93	TRB-93	Starlite Silver				TBR-94	TBD-94	TRB-94	Cosmic Copper				TBR-95	TBD-95	TRB-95	Lightning Black
			TBR-96	TBD-96	TRB-96	Rocket Red Gold				TBR-97	TBD-97	TRB-97	Crimson Coppe														





EXPOSITORES · DISPLAYS · PRESENTOIRS

1

CONTENIDO
CONTENT
CONTENU

12 COLORES
COLOURS
COULEURS
6 UNIDADES POR COLOR
UNITÉS POR COULEUR
UNITS PER COULEUR

TBR-...

11/17/21/23/34/38
54/61/80/82/91/92

42,5x38,5x20,5cm

DIS706-A



CONTENIDO
CONTENT
CONTENU

18 COLORES
COLOURS
COULEURS
6 UNIDADES POR COLOR
UNITÉS POR COULEUR
UNITS PER COULEUR

TBD-...

11/18/23/34/37/38
42/61/62/75/76/80
82/91/92/93/96/97

22,5x38,5x20,5cm

DIS762



SETS TINTA BRILLANCE

TBD-100-...

32x50mm

1



TBD-100-001
Basics



011 018 023 082

TBD-100-002
Jewel tone



034 036 037 038

TBD-100-003
Earth tone



053 054 064 080

TBD-100-005
Two tone



090 095 096 097

TBD-100-006
Planetary

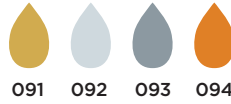

091 092 093 094

TBD-100-007
Tree house



042 021 075 076



Ideal sobre superficies oscuras.
Suitable for dark surfaces.
Idéal sur les surfaces sombres.

Utilización como pintura.
Use as paint.
Utiliser en tant que peinture.

Estampar sobre pasta polimérica.
Stamp on polymer clay.
Tamponer sur argile polymère.

+i

Tinta de alta opacidad que funciona muy bien en papel oscuro. Es fácil de extender y puede ser utilizada como pintura. También se puede mezclar con arcilla. Use la tinta con el aplicador difuminador o esponja para crear fondos con diferentes efectos. No permita que la almohadilla se seque por completo. Vuelva a colocar la tapa interior de plástico y tapar después de su uso. Las tapas interiores no son necesarias en las Dew Drops.

High opacity ink, works wonderfully on dark paper. Ink (from inker) is easy to spread and can be used as paint. Ink can also be mixed into clay. Use ink with the Squeegee or Sponge Daubers to create different background effects. Do not allow pad to dry out completely. Replace inner plastic cover and cover after use. Exposure to air will cause the inkpad to dry out. (Inner covers not required for Dew Drop pads.)

Encre de haute opacité qui fonctionne très bien sur le papier sombre. Facile d'étendre et peut être utilisé comme peinture. On peut également le mélanger avec de l'argile. Utilisez l'encre avec l'applicateur barbouilleur ou éponge pour créer des fonds ayant des effets différents. Ne laissez pas l'éponge se sécher complètement. Remettez le couvercle intérieur en plastique et fermez après usage. L'exposition à l'environnement fera que l'encre de l'éponge se sèche. Les couvercles intérieurs ne sont pas nécessaires pour les Dew Drops.



VERSAMAGIC

Tinta pigmento efecto tiza.
Pigment chalk ink.
Encre effect chalk,



TVG-...

95x65mm

6



TGD-...

32x50mm

6



TRG-...

Refill
20ml

3



TINTA BASE AGUA
WATER BASED INK
ENCRE BASE EAU

TINTA PIGMENTO
PIGMENT INK
ENCRE PIGMENT

REPUJAR
EMBOSS
EMBOSSER

SECADO AIRE
AIR INK
SECHAGE AIR

APLICACIÓN: Papel liso, papel texturizado, piel, pergamino, papel foto, cuero, celofán, madera natural, pasta polimérica, plástico shrink, terracota.

APPLICATION: Uncoated paper, coated paper, vellum, photo, leather(tanned leather), cellophane, unpainted wood, polymer clay, shrink plastic, terracotta.

APPLICATION: Papier lisse, papier texturé, cuir, parchemin, papier photo, cellophane, bois naturel, pâte polymérique, plastique shrink, terre cuite.



El tiempo de secado es de 10 a 15 minutos sobre papel liso. Se incrementará en papeles texturizados. Variará según el material, humedad, etc.

The drying time is 10 - 15 minutes on uncoated paper. It will increase on coated papers. Varies based on surface / material, humidity, etc.

Temps de séchage de 10 à 15 minutes sur le papier lisse. Il augmentera sur les papiers texturés. Varie en fonction du matériel, de l'humidité, etc.

EXPOSITORES
DISPLAYS
PRESENTOIRS

1

TVG-11	TGD-11	TRG-11	TVG-12	TGD-12	TRG-12	TVG-14	TRG-14	TVG-15	TGD-15	TRG-15	
Mango Madness	Red Magic	Concord Grape	Turquoise gem	Thatched Straw	Magnolia Bud	Persimmon	Pixie Dust	Spring Pansy	Pretty Petunia	Sea Breeze	Aquatic Splash
Key Lime	Cornucopia	Jumbo Java	Red Brick	Perfect Plumeria	Purple Hydrangea	Night Sky	Ocean Depth	Hint of Pesto	Spanish olive	Tea Leaves	Pumpkin Spice
Gingerbread	Eggplant	Sugarcane	Sahara Sand	Sierra Vista	Pink Grapefruit	Pink Petunia	Malted Mauve	Aspen Mist	Aegean Blue	Oasis Green	Aloe Vera
Niagara Mist	Wheat	Sage	Midnight Black	Cloud White							

12

COLORES
COLOURS
COULEURS

6

UNIDADES POR COLOR
UNITÉS POR COULEUR
UNITS PER COLOUR

TVG-...
12/15/31/36/37/52
59/54/61/78/91/92

42,5x38,5x20,5cm

DIS707-A

18

COLORES
COLOURS
COULEURS

6

UNIDADES POR COLOR
UNITÉS POR COULEUR
UNITS PER COLOUR

TGD-...
11/12/33/34/35/36
37/39/56/57/58/59
60/63/81/82/91/92

22,5x38,5x20,5cm

DIS763



SETS VERSAMAGIC

Para superficies claras y oscuras.
For light and dark surfaces.
Pour surfaces claires et obscures.



TGD-100-...

32x50mm

1

TGD-100-001
Pretty pastel



TGD-100-002
Jewel box



TGD-100-003
Fruit cocktail



TGD-100-004
Southwest



TGD-100-005
Seashore



TGD-100-006
Four corners



TGD-100-007
Flower pot



TGD-100-008
Harvest



TGD-100-009
Clowning around



Tinta acuarelabe.
Use as a watercolor ink.
Utiliser l'encre comme aquarelle.



Tinta para emboss.
Suitable ink for emboss.
Encre recommande par embosser.



**Para superficies
claras y oscuras.**
For light and dark surfaces.
Pour surfaces claires
et obscures.





VERSACOLOR

Tinta translúcida.
Translucent ink.
Encre translucide.



TVC1-...

95x65mm

6



TVS-...

33x33mm

10



TRV-...

Refill
15ml

3



TINTA BASE AGUA
WATER BASED INK
ENCRE BASE EAU

SUPERFICIES POROSAS
POROUS SURFACE
SURFACE POREUSES

REPUJAR
EMBOSS
EMBOSSER

APLICACIÓN: Papel liso.

APPLICATION: Uncoated paper.

APPLICATION: Papier lisse.



Tinta pigmento tradicional,
resistente a la luz.

Los colores metálicos tienen
base de aceite. El color de la
imagen estampada puede variar,
sobre todo en material ligero
como el papel liso.

Fade resistant, traditional pigment
ink.

Metallic colors are oil based.
Stamped image color may vary,
especially on light weight,
uncoated (ie. printer) paper.

Encre pigmentée traditionnelle,
qui résiste à la lumière.

Les couleurs métalliques ont
une base d'huile. La couleur de
l'image imprimée peut varier,
surtout pour le matériel léger
comme le papier lisse.



El tiempo de secado es de 10
a 15 minutos sobre papel liso.
Se incrementará en papeles
texturizados. Variará según el
material, humedad, etc...

The drying time is 10 to 15 minutes
on uncoated papers. Varies based
on weight / type of paper,
humidity, etc.

Le temps de séchage es de 10 à
15 minutes sur papier lisse. Varies
en fonction du matériel, humidité,
etc...

TVC1-11	TVS-11 Canary	TRV-11	TVC1-12	TVS-12 Marigold	TRV-12	TVC1-13	TVS-13 Orange	TRV-13	TVC1-14	TVS-14 Scarlet	TRV-14
TVC1-15	TVS-15 Magenta	TRV-15	TVC1-16	TVS-16 Peony	TRV-16	TVC1-17	TVS-17 Violet	TRV-17	TVC1-18	TVS-18 Royal Blue	TRV-18
TVC1-19	TVS-19 Cyan	TRV-19	TVC1-20	TVS-20 Turquoise	TRV-20	TVC1-21	TVS-21 Green	TRV-21	TVC1-22	TVS-22 Fresh Green	TRV-22
TVC1-23	TVS-23 Rose Red	TRV-23	TVC1-24	TVS-24 Opera Pink	TRV-24	TVC1-25	TVS-25 Cardinal	TRV-25	TVC1-26	TVS-26 Boysenberry	TRV-26
TVC1-27	TVS-27 Indigo	TRV-27	TVC1-28	TVS-28 Pacific	TRV-28	TVC1-29	TVS-29 Evergreen	TRV-29	TVC1-33	TVS-33 Pink	TRV-33
TVC1-34	TVS-34 Orchid	TRV-34	TVC1-35	TVS-35 Lilac	TRV-35	TVC1-36	TVS-36 Heliotrope	TRV-36	TVC1-37	TVS-37 Lavender	TRV-37
TVC1-38	TVS-38 Sky blue	TRV-38	TVC1-40	TVS-40 Mint	TRV-40	TVC1-42	TVS-42 Lime	TRV-42	TVC1-52	TVS-52 Topaz	TRV-52
TVC1-53	TVS-53 Cocoa	TRV-53	TVC1-54	TVS-54 Brown	TRV-54	TVC1-55	TVS-55 Umber	TRV-55	TVC1-56	TVS-56 Cinnamon	TRV-56
TVC1-57	TVS-57 Old Rose	TRV-57	TVC1-58	TVS-58 Smoke Blue	TRV-58	TVC1-60	TVS-60 Celadon	TRV-60	TVC1-61	TVS-61 Olive	TRV-61
TVC1-63	TVS-63 Split Pea	TRV-63	TVC1-64	TVS-64 Khaki	TRV-64	TVC1-66	TVS-66 Burgundy	TRV-66	TVC1-68	TVS-68 Atlantic	TRV-68
TVC1-69	TVS-69 Bumboo	TRV-69	TVC1-80	TVS-80 White	TRV-80	TVC1-81	TVS-81 Sky Gray	TRV-81	TVC1-82	TVS-82 Black	TRV-82
TVC1-83	TVS-83 Chateau Gray	TRV-83	TVC1-101	TVS-101 Camellia	TRV-101	TVC1-103	TVS-103 Imperial Blue	TRV-103	TVC1-104	TVS-104 Lagoon Blue	TRV-104



TVC1-... 🛒 6 TVS-... 🛒 10 TRV-... 🛒 3



La almohadilla de 5 colores puede ser utilizada DTP (pintura directa papel) para obtener un degradado y también para un repujado.

5 color pad could be used DTP (direct painting) for gradation effect as well as embossing.

L'éponge de 5 couleurs peut être utilisée DTP (peinture directe sur papier) afin de pouvoir obtenir un dégradé et aussi un gaufrage.

REPUJADO: Muy apropiado porque seca lentamente. (Se recomienda utilizar polvo transparente de repujado).

EMBOSSING: Very suitable since it dries slowly (recommended to use transparent embossing powder).

GAUFRAGE: Très pratique car il sèche lentement. (Il est conseillé d'utiliser de la poudre transparente de gaufrage).



TVC1-105	TVS-105	TRV-105	TVC1-131	TVS-131	TRV-131	TVC1-133	TRV-133	TVC1-134	TVS-134	TRV-134	
Tropical Green			Narcissus			Seashell		Petal Pink			
TVC1-135	TVS-135	TRV-135	TVC1-136	TVS-136	TRV-136	TVC1-138	TVS-138	TRV-138	TVC1-151	TVS-151	TRV-151
Hyacinth			Baby Blue			Seafoam		Sand Beige			
TVC1-152	TVS-152	TRV-152	TVC1-154	TVS-154	TRV-154	TVC1-155	TVS-155	TRV-155	TVC1-156	TVS-156	TRV-156
Ash Rose			Bark			Paprika		Raspberry			
TVC1-157	TVS-157	TRV-157	TVC1-158	TVS-158	TRV-158	TVC1-159	TVS-159	TRV-159	TVC1-160	TVS-160	TRV-160
Amethyst			Lapislazuli			Mountain Lake		Winter Green			
TVC-161	TVS-161	TRV-161	TVC-171	TVS-171	TRV-171	TVC-172	TVS-172	TRV-172	TVC-173	TVS-173	TRV-173
Green Tea			Pinecone			Grape		Neptune			
TVC1-174	TVS-174	TRV-174	TVC1-181	TVS-181	TRV-181	TVC1-182	TRV-182	TVC1-183	TVS-183	TRV-183	
Charcoal			Vanilla			Bisque		Cement			
TVC1-184	TVS-184	TRV-184	TVC1-185	TVS-185	TRV-185	TVC1-186	TVS-186	TRV-186	TVC1-187	TVS-187	TRV-187
Misty Mauve			Polar Blue			Lurel Leaf		Sage			



Tinta para emboss.
Suitable ink for emboss.
Encre recommandée par embosser.



Directo al papel o estampado.
Direct to paper or stamp.
Directe sur papier ou tamponer.



Tinta acuarelabé.
Use as a watercolor ink.
Utiliser l'encre comme aquarelle.

EXPOSITORES · DISPLAYS · PRESENTOIRS



CONTENIDO
CONTENT
CONTENU

12 COLORES
COLOURS
COULEURS
6 UNIDADES POR COLOR
UNITS PER COULEUR
UNITS PER COLOUR

TVC1-...
12/14/33/42/54/60
61/64/80/82/152/156



42,5x38,5x20,5cm

DIS708-A

CONTENIDO
CONTENT
CONTENU

24 COLORES
COLOURS
COULEURS
5 UNIDADES POR COLOR
UNITS PER COULEUR
UNITS PER COLOUR

TVS-...
11/12/14/15/17/34
35/36/37/38/53/54
56/63/80/82/136/151/171
173/174/181/183/187



22,5x38,5x20,5cm

DIS772

MULTI-COLOR almohadilla · pad · éponge

🛒 1

3 colores · 3 colors · 3 couleurs



TVC3 - ...

95x65mm - 50gr



TVC3-301
Noel



TVC3-302
Velveteen



TVC3-303
Cotton Candy



TVC3-305
Luster



TVC3-306
Indian Corn



TVC3-307
Firecracker



TVC3-308
Soft Petals



TVC3-309
Lullaby



TVC3-310
Contempo



TVC3-311
Antique

5 colores · 5 colors · 5 couleurs



TVC5 - ...

95x65mm - 50gr



TVC5-501
Fiesta



TVC5-502
Passion Fruit



TVC5-503
Limone



TVC5-504
Lollipop



TVC5-505
Icicle



TVC5-506
Rainforest



TVC5-507
Wild Berries



TVC5-508
Mocha Truffle



VERSAFINE

Tinta de colores vintage.
Vintage colors ink.
Encre de couleurs vintage,



TVFS-...

33x33mm

🛒 10



TRF-...

Refill
15ml

🛒 3



TINTA BASE ACEITE
OIL BASED INK
ENCRE BASE HUILLE

SUPERFICIES POROSAS
POROUS SURFACE
SURFACE POREUSES

SECAJE RÁPIDO
FAST DRYING
SECHAGE RAPIDE

TRANSLÚCIDA
TRASLUCENT
TRASLUCIDE



TVFS-11
Crimson Red



TVFS-18
Majestic Blue



TVFS-19
Deep Lagoon



TVFS-37
Imperial Purple



TVFS-83
Smoky Grey



TVFS-61
Olympia Green



TVFS-62
Spanish Moss



TVFS-82 TRF-082
Onyx Black



TVFS-54 TRF-054
Sepia Vintage



VERSAFINE CLAIR

Colores vivos.
Vibrant shades.
Couleurs vives.



TVF-CLA-...

76x35mm

3

La almohadilla de tinta tiene una tapa elevada que facilita su utilización. Mayor control en la aplicación con sellos. La caja es hermética y resulta más fácil de manejar, el diseño es más contemporáneo. La tinta tiene la misma calidad que la Versafine tradicional pero el pigmento es más profundo y más fuerte. Colores vivos. Apta para la técnica del embossing.

The ink pad has a lift off lid providing easier access. Increased control when inking stamps. The container is easier to handle and air tight. More contemporary label designs. It is the same ink quality but the pigment is deeper/stronger than in original Versafine. Vibrant shades. Embossable.

Le tampon encreur a un couvercle de décharge permettant un accès plus facile. Augmentation du contrôle lors de l’empreinte des timbres. Le récipient plus mince est plus facile à manipuler et étanche. Les dessins des étiquettes du couvercle ont un style plus contemporain. C’est la même qualité d’encre que celle de Versafine traditionnel, mais le pigment est plus profond/plus fort. Couleurs vives.

+i

Tinta más adecuada para los sellos actuales ya que permite que las líneas sólidas de las imágenes aparezcan mucho más nítidas.

More suitable ink for current stamps, the solid lines in images now appear much sharper.

Encre plus adapté pour les timbres actuels, les lignes solides des images semblent plus nettes.



TVF-CLA-101

delicia púrpura - purple delight
délícies pourpes



TVF-CLA-102

fantasía - fantasia - fantasia



TVF-CLA-151

chianti



TVF-CLA-152

monarca - monarch - monarque



TVF-CLA-201

glamuroso - glamorous
glamour



TVF-CLA-351

nocturno - nocturne
nocturne



TVF-CLA-352

bruma matinal - morning mist
brume du matin



TVF-CLA-451

hojas caídas - fallen leaves
feuilles mortes



TVF-CLA-452
piña de pino - pinecone
pomme de pin



TVF-CLA-453
bellota - acorn - gland



TVF-CLA-501
oasis verde - green oasis
oasis verte



TVF-CLA-502
frondoso - verdant - verdoyant



TVF-CLA-551
selva tropical - rain forest
forêt tropicale



TVF-CLA-552
senda umbrosa - shady lane
chemin ombragé



TVF-CLA-601
belle azul - blue belle
belle bleue



TVF-CLA-602
paraíso - paradise - paradis



TVF-CLA-603
brisa cálida - warm breeze
brise chaude



TVF-CLA-651
azul medieval - medieval blue
blue médiéval



TVF-CLA-652
crepúsculo - twilight - crépuscule



TVF-CLA-701
verano - summertime - été



TVF-CLA-702
rojo tulipán - tulip red
tulipe rouge



TVF-CLA-801
rosa fascinante - charming pink
rose charmant



TVF-CLA-901
alegre - cheerful - joyeux



TVF-CLA-951
prado dorado - golden meadow
prairie d'or

EXPOSITOR · DISPLAY · PRESENTOIR



12 COLORES
COULEURS
6 UNIDADES POR COLOR
UNITÉS POR COULEUR
UNITS PER COLOUR

CONTENIDO · CONTENT · CONTENU
42,5x38,5x20,5cm

TVF-CLA-...
101/102/151/152/351/452
453/501/502/601/701/951

DIS712-A





VERSACRAFT

Tinta para tela.
Fabric ink.
Encre pour tissu.



TVK-...

95x65mm

6



TVKS-...

33x33mm

10



TRVK-...

Refill
15ml

3



TINTA BASE AGUA
WATER BASED INK
ENCRE BASE EAU

SUPERFICIES POROSAS
POROUS SURFACE
SURFACE POREUSES

SECAJE AIRE
AIR INK
SÉCHAGE AIR

TERMOFIJACIÓN
HEAT SET
THERMO FIXÉ

REPUJAR
EMBOSS
EMBOSSER

APLICACIÓN: Tela, madera natural, papel liso, papeles japoneses, cuero, cerámica no esmaltada.

APPLICATION: Fabric, unpainted wood, uncoated paper, japanese papers, leather (tanned leather), unglazed pottery.

APPLICATION: Tissu, bois naturel, papier lisse, papier japonais, cuir, céramique non émaillée.

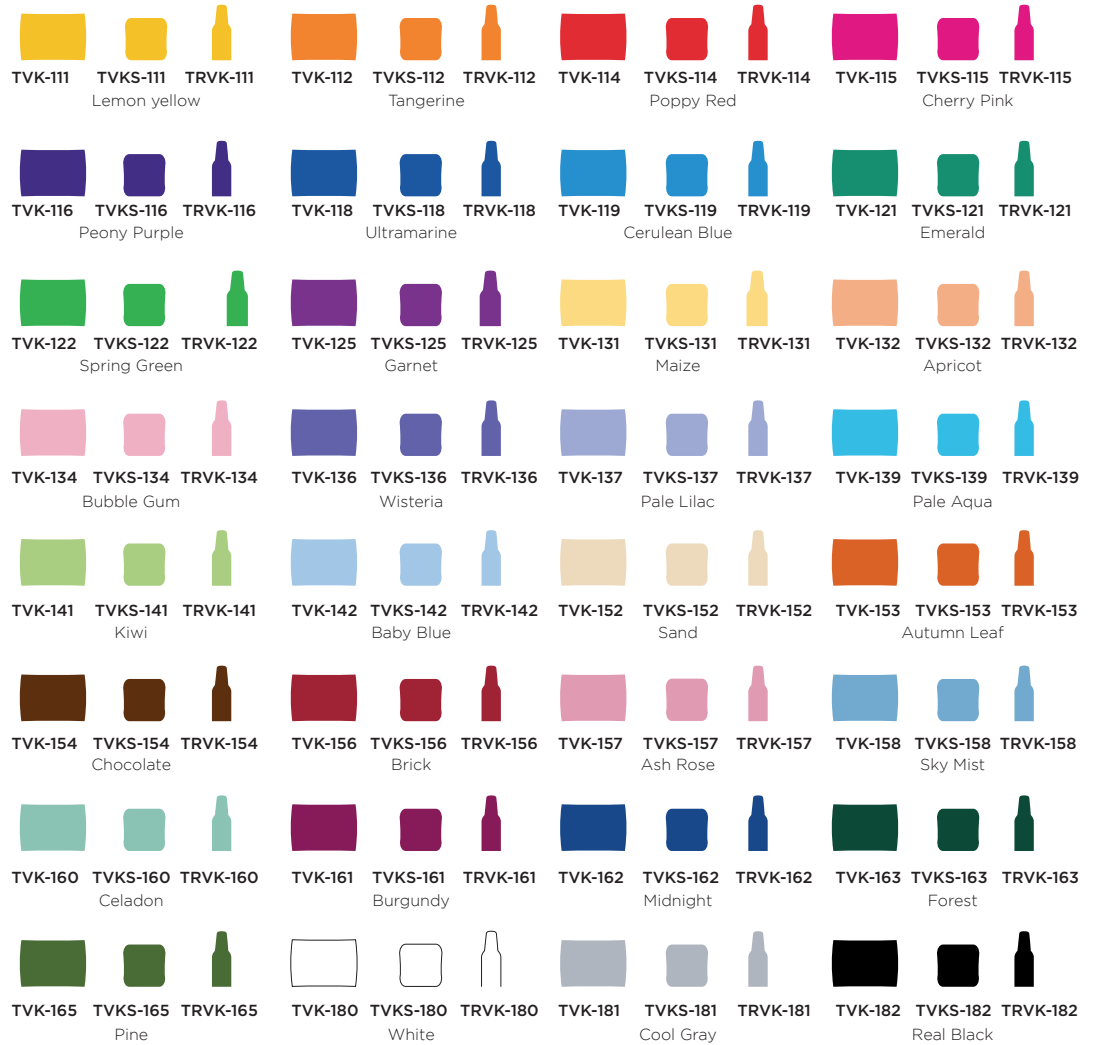

EXPOSITORES · DISPLAYS · PRENTOIRS

1



CONTENIDO · CONTENT · CONTENU

12
6

COLORES
COLOURS
COULEURS

UNIDADES POR COLOR
UNITÉS POR COULEUR
UNITS PER COLOUR

TVK-...

154/153/141/139/134/131
116/114/112/156/180/182

42,5x38,5x20,5cm

DIS711-A



CONTENIDO · CONTENT · CONTENU

24
5

COLORES
COLOURS
COULEURS

UNIDADES POR COLOR
UNITÉS POR COULEUR
UNITS PER COLOUR

TVKS-...

112/114/115/116/118/119
121/122/125/131/132/134
137/142/153/156/158/160
161/162/163/180/181/182

22,5x38,5x20,5cm

DIS773



Fijación con plancha.
Iron fixation.
Fixation à fer.

Tabla de compatibilidades - Compatibility chart
Tableau de compatibilités

Apropiado Appropriate Approprié	ALGODÓN Cotton Coton	LINO Linen Lin	SEDA Silk Soie	RAYÓN Rayon Rayon	POLIESTER Polyester Polyester
Estampar Stamping Timbrer	XXX	XXX	XXX	XX	XX
Lavado a mano Hand washing Laver à main	XXX	XXX	XXX	XXX	XXX
Lavado máquina Washing machine Lavage machine	XXX	XXX	XX	X	

Estampado con sellos.
Stamp.
Estamper avec tampons.

ERRASABLE FABRIC INK

Tinta soluble al agua..
Water soluble ink.
Encre soluble à l'eau.



TER-000

95x65mm

3



TINTA BASE AGUA
WATER BASED INK
ENCRE BASE EAU

DESAPARECE AL LAVAR
DISAPPEAR WHEN
CLEANING
DISPARAÎTRE LORS DU
NETTOYAGE

SECADO AIRE
AIR INK
SÉCHAGE AIR

APLICACIÓN: Sobre tela
—
APPLICATION: Fabric
—
APPLICATION: Tissu



Tinta fantasma para marcar imágenes en textiles y convertirlas en proyectos de bordado.

Probar siempre en un trozo de material antes de usar en el proyecto final.

La tinta se puede lavar con agua o borrar con un paño húmedo.

Aplicar la almohadilla sobre la superficie a estampar para entintar la imagen de manera uniforme.

Los sellos se pueden limpiar. Para el uso en telas de color claro (no se verá en telas de colores oscuros.)



Se seca en segundos sobre el algodón. Varía según el material, humedad, etc...

Dries in seconds on cotton. Varies based on material, humidity, etc...

Se sèche en quelques secondes sur le coton. Varie dépendant du matériel, de l'humidité, etc...

For stamping images onto textiles for embroidery projects. Always test on a scrap piece of material before using on final project.
Ink can be washed off with water or blotted off with a wet cloth.

Tap the pad onto the stamp surface to ink the image evenly. Stamps can be wiped clean. For use with light colored fabrics (will not show on dark colored fabrics.)

Pour marquer des images sur textile et les transformer en des projets de broderie.

Essayez toujours sur un morceau de matériel avant de l'utiliser sur le projet final.

L'encre peut se laver avec de l'eau ou s'effacer avec un chiffon humide.

Appliquez l'éponge sur la surface à timbrer pour encre l'image de façon uniforme.

Les timbres peuvent se laver. Pour l'utilisation sur tissu de couleur claire (ne se verra pas sur tissu de couleurs sombres).



Estampado del proyecto.
Project stamping.
Tamponner le projet.



Bordado del proyecto.
Embroidery project.
Projet de broderie.



FABRICO

Rotulador para tela dual.
Dual fabric marker pen.
Feutre dual pour tissu.

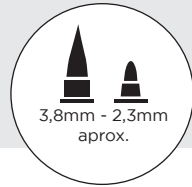

3,8mm - 2,3mm
aprox.



TFAM-...
6



TPF-...
1



Diseñar sobre tela.
Fabric design.
Dessin sur tissu.



Fijar con plancha , 15 min.
Iron fixation, 15 min.
Fixer avec fer, 15 min.

TFAM-111 Lemon yellow	TFAM-112 Tangerine	TFAM-114 Poppy Red	TFAM-115 Cherry Pink
TFAM-116 Peony Purple	TFAM-118 Ultramarine	TFAM-119 Cerulean Blue	TFAM-120 Tropical Lagoon
TFAM-121 Emerald	TFAM-122 Spring Green	TFAM-125 Garnet	TFAM-132 Apricot
TFAM-134 Bubble Gum	TFAM-136 Wisteria	TFAM-137 Pale Lilac	TFAM-139 Pale Aqua
TFAM-141 Kiwi	TFAM-142 Baby Blue	TFAM-152 Sand	TFAM-153 Autumn Leaf
TFAM-154 Chocolate	TFAM-155 Truffle	TFAM-156 Brick	TFAM-157 Ash Rose
TFAM-158 Sky Mist	TFAM-160 Celadon	TFAM-161 Burgundy	TFAM-162 Midnight
TFAM-163 Forest	TFAM-165 Pine	TFAM-167 Pea Pod	TFAM-181 Cold Gray
TFAM-182 Real Black			

Sets de 6 rotuladores para tela 2 puntas

Sets 6 fabric pens 2 tips · Sets 6 feutres pour tissu 2 pointes

GAMA ROTULADORES FABRICO

(solo contenido)
FABRIC MARKER RANGE
(Contents only)
GAMME FEUTRES FABRICO
(Seulement le contenu)



89311

24 colores x 6 = 144u

89321

12 colores x 6 = 72u
*no photo

TPF-100-007 - STANDARD

	114	
	112	
	111	
	121	
	118	
	182	

TPF-200-007 - PASTEL

	157	
	160	
	158	
	136	
	152	
	181	

TPF-300-007 - SORBET

	131	
	132	
	134	
	141	
	142	
	137	

TPF-400-007 - LANDSCAPE

	156	
	162	
	154	
	125	
	153	
	165	

TPF-500-007 - GEMSTONES

	115	
	110	
	167	
	120	
	119	
	116	

TPF-600-007 - ARBORETUM

	155	
	161	
	106	
	139	
	122	
	163	



VERSAMARK

Tinta transparente.
Transparent ink.
Encre transparent.



TVM-001

95x65mm



6



TVM-500

33x33mm



10



TVMR

Refill

15ml



3



TINTA BASE ACEITE
OIL BASED INK
ENCRE BASE HUILE

REPUJAR
EMBOSS
EMBOSSER

APLICACIÓN: Papel texturizado, papel satinado (para técnicas de reserva).

APPLICATION: Uncoated paper, glossy paper (for resist techniques).

APPLICATION: Papier texturé, papier satin (pour des techniques de réserve).



El tiempo de secado es de 5 a 10 minutos sobre papeles lisos.

The drying time is 5 to 10 minutes on uncoated papers.

Le temps de séchage est de 5 à 10 minutes sur papier lisse.

Rotulador Dual • Dual marker pen • Feutre dual



3,8/2,3mm. aprox.

TVMP



6



Estampe en cartulina de color de alta calidad para lograr un efecto duotono. Estampe en papel blanco extra ligero para crear una marca de agua. Para conseguir un efecto degradado, utilice pinceles para aplicar tiza o polvo perlado a las imágenes estampadas. Utilice VersaMark en papel estucado con tintas teñidas para conseguir efectos reserva. Limpie los sellos inmediatamente después de usar con el sello Cleaner. Si la superficie de la almohadilla se ve sucia, limpie con una toalla de papel y vuelva a entintar con el entintador.

Stamp onto high quality colored cardstock to achieve a two toned effect. Stamp onto extra light weight white paper to create a watermark. For a gradient effect, use brushes to apply chalk or pearl powders to stamped images. Powders adhere well to this high viscosity ink. Use VersaMark on coated paper with dye inks for resist effects. Clean stamps immediately after use with Stamp Cleaner. If the surface of the pad appears dirty, wipe clean with a paper towel and re-ink.

Timbrez sur du carton de couleur de haute qualité pour obtenir un effet duotons. Timbrez sur du papier blanc extra léger pour obtenir une marque d'eau. Pour obtenir un effet dégradé, utilisez les pinceaux pour appliquer la craie ou la poudre perlée aux images timbrées. La poudre s'adhère parfaitement à cette encre de haute viscosité. Nettoyez les timbres immédiatement après utilisation avec le timbre Cleaner. Si la surface de l'éponge se voit sale, nettoyez avec une serviette de papier et mettez à nouveau de l'encre avec l'encreur.



Tiza o polvos perlados.
Chalk or embossing powder.
Chalk ou poudre a embosser.



Efecto duotono.
Two tone effect.
Effet duo tons.



Especial emboss
Special emboss
Gaufrage spécial

VERSAMARK DAZZLE

Tinta brillante o glaseados • Shimmer or frost Ink • Encre brillante ou vitrée



TVM-002

95x65mm - 50gr



6



TRM-002

15ml



3



TVM-003

95x65mm - 50gr



6



TRM-003

15ml



3



Para un resultado resplandeciente, aplicar la tinta Memento en papel estucado de color claro con un pincel. Una vez que la imagen está seca, estampar con VersaMark Dazzle y repujar con polvos transparentes. La purpurina puede borrarse si se toca en exceso una vez acabado.

For an especially glimmering image, apply Memento ink to light colored coated paper with a brush. Once dry, stamp image with VersaMark Dazzle and emboss with clear powder. Glitter may rub off when touched.

Pour une image spécialement resplendissante, appliquer l'encre Memento sur papier enduit de couleur clair avec un pinceau. Une fois l'image sèche, timbrez avec VersaMark Dazzle et repoussez avec de la poudre transparente. Le glitter peut s'effacer quand on le touche.



EMBOSS

POLVO DE REPUJADO
EMBOSS POWDER
POUDRE EMBOSSER

CALOR
HEAT
CHALEUR

REPUJAR
EMBOSS
EMBOSSER

TINTA BASE AGUA
WATER BASED INK
ENCRE BASE EAU

TINTA PIGMENTO
PIGMENT INK
ENCRE PIGMENT

REPUJAR
EMBOSS
EMBOSSER



TIPO OPACO - OPAQUE TYPES - TYPE OPAQUE



TEP-301
Gold



TEP-302
Silver



TEP-303
Copper



TEP-304
White



TIPO TRANSPARENTE - CLEAR TYPES - TYPE TRANSPARENT



TEP-305
Clear



TEP-306
Sparkle



TEP-307
Bridal



TEP-308
Pearl

TEP-...
30ml



TEM-103
CLEAR (transparente)

TEM-104
TINTED PINK

95x65mm - 50gr



TEM-403
CLEAR (transparente)

TEM-404
TINTED PINK

15ml

APLICACIÓN: Papeles lisos y texturizados, pergamino.

APPLICATION: Coated paper, uncoated paper, vellum.

APPLICATION: Papier lisse et texturé, parchemin.



Calentar el polvo de relieve hasta que se derrita. Tardará unos 20 - 30 segundos aprox. usando una pistola de aire caliente. El tiempo de disolución variará de acuerdo con la cantidad de polvo.

Heat embossing powder until it melts. It will take approximate 20 - 30 seconds using an embossing heat gun.) Melting time will vary according to the amount of powder.

Chauffer la poudre à embosser jusqu'à ce qu'il fonde. Il faut 20-30 secondes approx. en utilisant un pistolet à air chaud. Le temps de dissolution varie en fonction de la quantité de poudre.



Espolvoree el polvo de relieve sobre la imagen estampada o dibujada. Una vez calentado, el polvo se funde y la superficie se repujará.

Se recomienda el uso de polvos de relieve transparentes cuando se utilizan tintas de color. Recomendamos el uso de tintas transparentes, VersaMark o Emboss Pen Clear al usar polvos de relieve opacos.

Usar mucho polvo cuando se repuje. Limpiar el polvo sobrante con un cepillo y verter el exceso en el bote para su uso futuro.

Las imágenes estampadas en superficies no porosas pueden borrarse si se manipula en varias ocasiones. Se recomienda utilizar pistola de calor cuando se usan polvos de relieve.

No se recomienda para repujar tejidos. No usar secador del pelo como fuente de calor.

Sprinkle embossing powder over stamped or drawn image. Once heated, the powder will melt and the surface will rise. We recommend using transparent embossing powders when using colored inks.

We recommend using clear inks (such as Emboss, VersaMark or Emboss Pen Clear) when using opaque embossing powders.

When embossing use plenty of powder. Dust off stray powder with a brush and pour the excess into bottle for future use. Stamped images on non-porous surfaces may rub off if handled repeatedly.

An embossing heat gun is the recommended heat source for use with Emboss powders. It is not recommended to emboss on textiles.

Please do not use a hair dryer as the heat source.

Saupoudrer la poudre de relief sur l'image timbrée ou dessinée.

Une fois chauffée, la poudre se fond et la surface sera embossée. Il est conseillé l'usage d'encres transparentes quand on utilise des encres de couleur. Il est conseillé l'usage d'encres transparentes VersaMark ou Emboss Pen Clear quand on utilise les poudres de relief opaques.

Utilisez beaucoup de poudre au moment de repousser. Nettoyez la poudre restante avec une brosse et versez l'excès dans la bouteille pour une future utilisation.

Les images timbrées sur des surfaces non poreuses peuvent s'effacer si on les manipule plusieurs fois. Il est conseillé d'utiliser le pistolet de chaleur lorsqu'on utilise des poudres de relief.

Non conseillé pour repousser les tissus. Ne pas utiliser le séchoir à cheveux comme source de chaleur.



Estampar con sellos con la tinta emboss stamp pad.
 Stamping with the emboss stamp pad.
 Tamponner avec le emboss stamp pad.



Espolvorear inmediatamente polvo sobre la imagen estampada. Aplicar generosamente para que el polvo se adhiera de manera uniforme. Retire el exceso de polvo. Devolver el exceso de polvo a la botella.

Immediately sprinkle powder onto stamped image. Apply liberally so that powder adheres evenly. Return excess powder to bottle. Saupoudrez immédiatement la poudre sur l'image timbrée. Appliquez généreusement afin que la poudre s'adhère de façon uniforme. Remettre l'excès de poudre dans la bouteille.



Utilice una pistola de calor para fundir el polvo. Tenga cuidado al aplicar calor. Las fuentes de calor pueden causar quemaduras.

Use an embossing heat gun to melt powder. Use caution when applying heat. Heat sources can cause burns.

Utilisez un pistolet de chaleur pour fondre la poudre. Faites attention au moment d'appliquer la chaleur. Les sources de chaleur peuvent provoquer des brûlures.



Rotulador dual con tinta repujar caligrafía 1 · Calligraphy embossing pen dual 1 · Feutre dual embosser caligraphie 1



TINTA BASE AGUA
 WATER BASED INK
 ENCRE BASE EAU

TINTA COLORANTE
 DYE INK
 ENCRE TEINTÉE

REPUJAR
 EMBOSS
 EMBOSSER



TEM-...
 3,5mm 6



TEM-2
 Tangerine



TEM-5
 Carmine



TEM-7
 Pansy

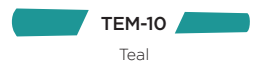

TEM-10
 Teal



TEM-11
 Emerald

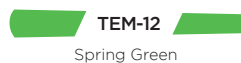

TEM-12
 Spring Green



TEM-32
 Cupid Pink

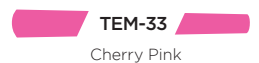

TEM-33
 Cherry Pink



TEM-34
 Lilac



TEM-35
 Wisteria



TEM-36
 Lavender



TEM-38
 Pale Aqua



TEM-39
 Nile Green



TEM-53
 Garnet



TEM-55
 Indigo Blue



TEM-56
 Bottle Green

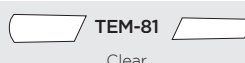

TEM-81
 Clear

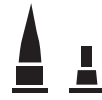

TEM2-...
2mm 6

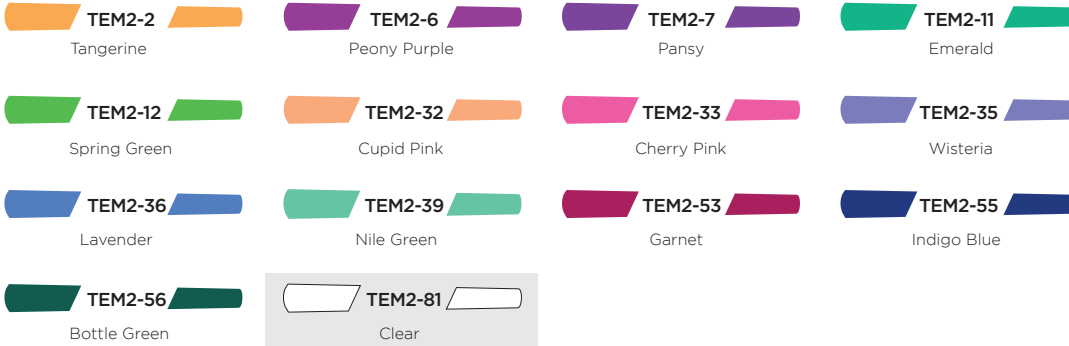

Usando tinta transparente resalta el color de fondo del rotulador utilizado.

Using transparent ink highlights the background color of the pen used.

En utilisant l'encre transparent met en évidence la couleur du feutre utilisé au fond.



Utilizar varios colores.

Use various colors.

Utiliser différentes couleurs.



Aplicación de polvo transparente.

Apply transparent powder.

Application de poudres transparent.





GLUE PAD

Almohadilla de cola
Glue Pad
Éponge à colle

🛒 1



TGP-002

50gr - 15ml

Cola en almohadilla para embellecer sus diseños estampados con hojas, hoja de metal, polvo y purpurina de grano fino. Transparente cuando seca. No se requiere aplicar calor.

For embellishing your stamped designs with foils, lamé, powders and (fine grain) glitter. Dries clear. No heat required.

Pour embellir vos dessins timbrés avec des feuilles, feuille de métal, poudre et purpurine de grain fin. Transparent une fois sec. Aucun besoin de chaleur.



TRP-002

15ml



Si el pegamento se seca en la almohadilla, lavar el pegamento seco, dejar secar la almohadilla y retintar con el entintador Glue Pad.

If glue dries on pad, wash off the dried glue and allow pad to dry. Re-ink pad with Glue Pad ink.

Si la colle se sèche sur l'éponge, lavez la colle sèche et laissez sécher l'éponge. Remettre de l'encre avec l'encrier Glue Pad.

APLICACIÓN CON SELLO - APPLICATION WITH STAMPS - APPLICATION AVEC TAMPONS



Aplicar la cola glue pad.
Apply glue to pad.
Appliquer la colle.



Estampar con el sello.
Stamping with stamp.
Tamponer avec le tampon.



Presionar el pan de oro.
Press the gold foil.
Pressée la feuille d'or.



Retirar el exceso de cola.
Removing excess glue.
Enlever l'excès de colle.

TACK'N PEEL

Goma transparente reutilizable diseñada para pegar sellos de estampación. Para restaurar la adherencia de la goma enjuagar con agua.

Tack 'n Peel reusable clear sheet is a unique, product designed for creating a stamping block. The adhesive layer can be easily preserved by simply rinsing the surface with water and then air drying, stickiness restores over and over again.

Gomme transparente réutilisable conçue pour coller les timbres de l'estampage. La couche adhésive peut être facilement gardée en rinçant la surface avec de l'eau puis en séchant naturellement, l'adhérence réapparaît une et une autre fois.

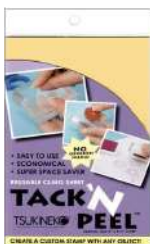

TTP-001

🛒 6

SET DEDALES-ESPONJA 3PC SPONGE DAUBER 3PC SET SET ÉPONGE-APPLICATEUR 3PC

Paquete de 3 dedales aplicadores con capucha con suave esponja redondeada en la punta para crear suaves efectos de aerógrafo en papel.

These unique applicators have a rounded sponge tip for creating soft airbrush effects on paper. Try them for stenciling and rubber stamping or use them to apply ink directly to the paper.

Paquet de 3 de applicateurs avec capuchon et suave éponge arrondie sur la pointe afin de pouvoir créer de suaves effets de aérographe sur papier.



TSP-SB

🛒 6

LIMPIADOR STAZON STAZON CLEANER NETTOYEUR SPRAY STAZON

Cuenta con aplicador y es perfecto para limpiar tus sellos tras usarlos con tintas. Libre de ácidos.

StazOn All-Purpose Cleaner is acid-free, safe and reliable on all your stamps, including acrylic! uninked pad and the Tsukineko inkers.

Nettoyeur multiples utilisations, libre d'acide, pour utiliser de façon sûre sur tous les estampa-ges, inclus les acryliques.



56ml

TSZL-56

🛒 6

FANTASTIX BRUSH

Difuminador punta cónica
Smudger conical tip
Pour estomper, pointe conique



TFX-BR

🛒 10

FANTASTIX BULLET

Difuminador punta redonda
Smudger round tip
Pour estomper, pointe arrondie



TFX-BL

🛒 10



FIREWORKS

Tinta de manualidades en spray para crear efecto brillo y destellos de color.

Craft ink spray that creates colored shimmer and sparkle effects.

Encre de l'artisanat en spray pour créer des effets éclat et chatolement des couleurs.



FW-000-...
15ml 🛒 6

FW-000-100	FW-000-601
FW-000-103	FW-000-604
FW-000-200	FW-000-608
FW-000-300	FW-000-701
FW-000-301	FW-000-703
FW-000-400	FW-000-704
FW-000-404	FW-000-707
FW-000-500	FW-000-800
FW-000-501	FW-000-801
FW-000-504	FW-000-804
FW-000-506	FW-000-900
FW-000-600	FW-000-901

Set 3 sprays



FW-003 001	FW-003 003	FW-003 005
100	500	804
200	501	801
300	504	800
FW-003 002	FW-003 004	FW-003 006
703	604	404
707	601	400
701	608	901

FW-003-...
15ml 🛒 1

Set 72 sprays + display

🛒 1
12 colores
(6 sprays de 15ml de cada color)
413 x 254 x 305 mm

6 each of 12 colors
16.25"w x 10"d x 12"h

12 couleurs
(6 sprays 15ml de chaque couleur)
413 x 254 x 305 mm

300	601	301	608
200	600	400	707
103	501	404	704
100	500	506	804
703	800	504	801
701	900	604	901
FW-100-072	FW-200-072		



Con plantillas y espátula.
With stencils and palette knife.
Avec pochoirs et spatule.



Aplicación con spray directo.
Direct application from spray.
Application directe avec spray.



Pintar directamente con pincel.
Paint with brush.
Peindre directement avec la brosse.



GLĀZON

Tinta ideal para técnicas mixtas y superficies no porosas.

Perfect ink for mixed media objects and non-porous surfaces.

Tinte idéal pour des travaux de techniques mixtes et des surfaces non poreuses.



 **GZ-000-001**
GlazOn Original

 **GZ-000-003**
GlazOn Matte

 **GZ-000-007**
GlazOn Vintage

15ml  3



Realiza múltiples capas de tintas StazOn con una capa de GlazOn después de la aplicación de cada color para prevenir la migración del color. Ideal para trabajos de técnicas mixtas y superficies no porosas como metal, acrílico y mucho más.

Se seca rápidamente.

“Set” multiple layers of StazOn inks with a layer of GlazOn after each color application to prevent color migration. Great for mixed media objects and non-porous surfaces like metal, acrylic and more. Dries quickly.

Réalisez plusieurs couches d'encre StazOn avec une couche de GlazOn après l'application de chaque couleur pour prévenir la migration de couleur. Il est idéal pour des travaux de techniques mixtes et des surfaces non poreuses comme métal, acrylique et plus.

De séchage rapide.

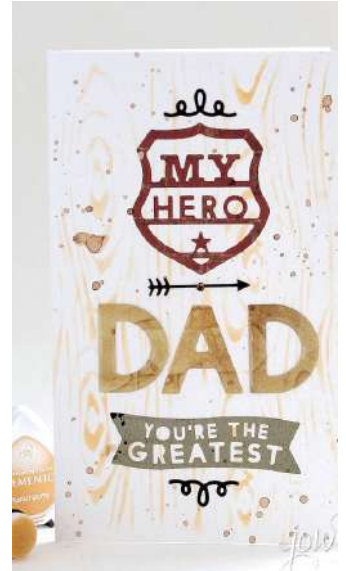

Aplicar tinta en superficie porosa.

Applying ink on porous surface.

Application d'encre sur la surface poreuse.



Con esponja aplicar una capa fina. Secaje 10 minutos.

Apply GlazOn with a sponge, a thin layer. Dry in 10 minutes.

Appliquer une mince couche de GlazOn avec l'éponge. Sèche en 10 minutes.



Estampamos encima.

Stamp above.

Estamper au dessus.



Aplicamos otra capa de GlazOn y queda totalmente protegido.

Apply another layer of GlazOn and is fully protected.

Appliquer une autre couche de GlazOn et est entièrement protégée.

GOOSEBUMPS

Para un acabado con relieve único.
For a unique textured finish.
Pour une finition texturée unique.



TS-000-...

15ml



TS-DAU-...

Bote punta esponja 15ml
Dauber top bottle 0.5 fl oz
Bouteille dauber top 15ml



GooseBumps Original Transparent
TS-000-001

GooseBumps Matte
TS-000-003

Goose Bumps Shimmer
TS-000-005

Goose Bumps Original Transparent
TS-DAU-001

GooseBumps Matte
TS-DAU-003

Goose Bumps Shimmer
TS-DAU-005

Display Set 54u.

CONTENIDO

- 6 x spray relieve
GooseBumps Original
(transparente, mate y brillante);

- 12 x GlazOn
(transparente, mate y vintage)

413x254x305mm

GZ-100-054



TÉCNICAS CON GOOSEBUMPS - TECHNIQUES WITH GOOSEBUMPS TECHNIQUES AVEC GOOSEBUMPS



Limpiar con un trapo la boquilla y el tapón inmediatamente después de su uso.

Wipe the nozzle and cap immediately after use.

Essuyez le tuyau et le bouchon immédiatement après chaque usage.



Espolvoréalo
Pulveriza a 25-30cm de distancia para una superficie ligeramente texturizada.

Sprinkle
Spray from 10-12 inches for a lightly textured surface.

Aspergez-le
Pulvérisez à 25-30cm de distance pour une surface légèrement texturisée.



Textura
Pulveriza a 10-15cm. de distancia para una textura más intensa.

Texture
Spray from 4-6 inches for a heavier texture.

Texture
Pulvérisez à 10-15cm de distance pour une texture plus intense.



Extiéndelo
Rocía una capa gruesa directamente sobre la superficie o aplícalo con el bote con aplicador esponjita.

Spread It On
Spray a thick layer directly above the surface or apply with a dauber top.

Étendez-le
Pulvérisez une couche épaisse directement sur la surface ou appliquez-le avec une bouteille avec applicateur d'éponge.



TÉCNICA PARA CREAR RESERVAS - RESIST TECHNIQUES - TECHNIQUES DE REHAUT



Aplicar sobre una superficie como papel.
Apply on a surface.
Appliquer sur une surface.



Una vez seca, pintar encima.
Paint above once it's dried.
Une fois sec peindre.



Retirar el sobrante con un papel absorbente.
Remove excess with an absorbent paper.
Retirer l'excédent avec un papier absorbant.



INK POTION n°9

Solución para mezclas con tintas de base agua.

Ink blending solution for water-based inks.

Solution pour des mélanges avec des encres à base de l'eau.

IP-SML-001

Spray
Spray bottle
Bouteille spray

8ml

🛒 5



IP-000-001

Spray
Spray bottle
Bouteille spray

59ml

🛒 6



IP-000-002

Bote recarga
Refill
Bouteille recharge

236ml

🛒 1



Evita que el papel se arrugue una vez seco. Aplicar en proyectos para favorecer la migración de tintas o pulverizar encima de alfombrillas de tinta para efectos acuarela.

Resists paper curling when dried. Spray on projects to encourage migration of inks or spray on inked stamps for watercolor effects.

Elle résiste au froissement du papier quand il est sec. Appliquer sur des projets pour favoriser la migration des encres ou pulvériser sur des éponges d'encre pour des effets aquarelle.

Algunas formas de utilizar Ink Potion n°9 - A few ways to use Ink Potion n°9

Quelques façons d'utiliser Ink Potion n°9



1

Mezcla tintas VersaMagic con IP9 para sombras suaves y naturales.

Blend Versamagic inks with IP9 for soft, natural-looking shading.

Mélangez des encres VersaMagic avec IP9 pour des ombres douces et naturelles.

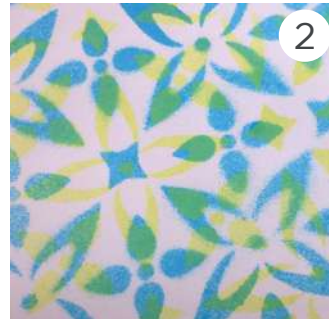

2

Mezcla IP9 con tintas de pigmento para sprays personalizados.

Mix IP9 with pigment inks for custom craft sprays.

Mélangez IP9 avec des encres à pigments pour des sprays personnalisés.



3

Entinta un rodillo, después rocíalo con IP9 para extender el color.

Ink a brayer, then spray with IP9 to extend your color.

Encrez un rouleau, après pulvérisez-le avec IP9 pour étendre la couleur.



TÉCNICAS CON INK POTION N° 9 - TECHNIQUES WITH INK POTION N° 9 - TECHNIQUES AVEC INK POTION N° 9



Para difuminar con tintas VersaMagic.
To blend with Versamagic inks.
Pour mélanger avec des encres Versamagic.



Crema tus colores y sprays con InkPotion y tus tintas.
Create your colors and sprays inks with InkPotion.
Créez votre couleurs et sprays et les encres InkPotion.



Efecto acuarela con irRESISTible.
Watercolor effect with irRESISTible.
Effet d'aquarelle avec irRESISTible.



irRESISTIBLE Texture Spray & irRESISTIBLE Pico Embellisher

Añade fabulosas texturas y resistentes y vibrantes colores. Adds fabulous texture and vibrant, fade-resistant color. Ajoutez des fabuleuses textures et des couleurs résistantes et vibrantes.

ACID FREE



IR-000-...
Spray Relieve
Texture Spray
Spray Texture

59ml
 6



IW-000-...
Bote cánula con punta
Pico Embellisher
Pico Embellisher

30ml
 6

+i

Se puede pulverizar, pintar con pincel, con esponja o utilizando sellos sobre cualquier superficie. Los colores se pueden entremezclar para conseguir tus propias tonalidades. Se puede utilizar con Ink Potion N° 9 para efectos acuarela únicos. Colores complementarios a la línea de tintas Memento. El bote cánula viene con un aplicador punta fina ideal para escribir, garabatear y para otro tipo de decoraciones. Hay una aguja incrustada en el tapón para evitar la obstrucción.

Can be sprayed, brushed, dabbed, or stamped on any surface. Colors are mixable for your own custom hues. Use with Ink Potion N° 9 for a unique watercolor effect. Offered in colors complementary to the Memento ink line. Pico Embellisher comes in a fine tipped applicator great for writing, doodling and other embellishing. Non-clog feature is built right into the cap.

On peut le pulvériser, peindre avec un pinceau, une éponge ou en utilisant des tampons encreurs sur n'importe quelle surface. On peut mélanger les couleurs pour obtenir des teintes personnalisées. On peut les utiliser avec de Ink Potion N° 9 pour des effets aquarelle uniques.

Couleurs complémentaires avec la ligne d'encre Memento. La bouteille canule vient avec un applicateur fin, idéal pour écrire ou gribouiller et pour autres types d'embellissements. Il y a une aiguille incrustée dans le bouchon pour éviter l'obstruction.

100	602	091
200	604	094
201	608	071
300	701	072
302	703	073
400	704	074
404	707	075
500	804	076
501	900	077
504	902	IW-000-001 transparente
506	910	IW-000-005 brillo
600	095	
601	092	



TÉCNICAS CON irRESISTible TEXTURE SPRAY - TECHNIQUES WITH irRESISTible TEXTURE SPRAY

TECHNIQUES AVEC irRESISTible TEXTURE SPRAY



Para crear embellecedores dejar secar la gota de tinta en una alfombrilla. Despegar y utilizar como embellecedor.

To create embellishments, let the drops dry, takes off and decorate.
Pour créer des embellissements, laisser sécher les gouttes, enlever et décorer.



Punta fina para caligrafía o dibujo.

Fine tip for calligraphy or drawing.
Pointe fine pour la calligraphie ou le dessin.



Con el spray creamos color con textura.

With the spray we can create color with texture.
Avec le spray nous créons la couleur avec texture.



SHEER SHIMMER SPRITZ

Spray embellecedor para añadir un toque de elegancia a papeles, cintas y flores. Fácil de aplicar, realiza los trabajos sin sobrecargarlos.

Embellisher spray to add a sheer touch of elegance to paper crafts, ribbons and flowers. Easy to apply and enhances artwork without overpowering your project.

Spray décorateur pour ajoutez une simple touche d'élégance aux papiers, rubans et fleurs. Facile d'appliquer, il rehausse des œuvres sans les accabler.



- Agitar bien para que las partículas metalizadas no queden pegadas al fondo.
- Pulverizar a 30-40cm. de distancia del proyecto (mayor distancia = pulverizado más fino).
- Pulverizar dos veces y dejar que el spray se extienda sobre el proyecto.
- Recargar cuando sea necesario utilizando el bote recarga.
- Shake well so metallic is no longer settled on the bottom.
- Spray at 12 to 16 inches from project (greater distance=finer mist).
- Spritz twice and allow mist to float to the project.
- Spritz again if desired (becomes more visible when dry).
- Refill as needed using the pour spout 2 fl. oz bottle!
- Agitez bien pour éviter que les particules métallisées restent collées au fond.
- Pulvérisez à 30-40cm de distance du projet (plus distance = pulvérisé plus fine).
- Pulvérisez deux fois et attendez que le spray s'étende.
- Rechargez quand vous avez besoin en utilisant la bouteille recharge.



Las pulverizaciones indirectas ofrecen mejores resultados. Utilízalo con moderación; Sheer- Shimmer Spritz aporta brillo con sólo un toque de color (idebe complementar tu trabajo, no sobrecargarlo!). Utilízalo como una capa base o un toque final para cualquier proyecto. Ideal también para cintas y proyectos florales.

Indirect spraying yields the best results. Use sparingly; Sheer Shimmer Spritz provides shimmer with only a hint of color (it should compliment your artwork, not overpower it!). Use a base layer or as a finishing touch for any project. Also great on ribbon and floral projects! Les pulvérisations indirectes offrent meilleurs résultats.

Utilisez-le avec modération; Sheer Shimmer Spritz apporte éclat avec simplement une touche de couleur (il doit compléter vos travaux, pas les maîtriser!) Utilisez-le comme une couche ou touche finale pour n'importe quel projet. Il est idéal aussi sur des rubans et projets de fleurs.

Spray
Spritzer
Spray
7ml



- IA-SML-001
- IA-SML-002
- IA-SML-003
- IA-SML-004
- IA-SML-005
- IA-SML-006

IA-SML-00...



5

Bote recarga
tapón rosca
Screwcap
bottle
refill



- IA-RFL-001
- IA-RFL-002
- IA-RFL-003
- IA-RFL-004
- IA-RFL-005
- IA-RFL-006

IA-RFL-00...



6

Set 96 sprays + DISPLAY

24u color Escarcha - Frost - Givre
24u color Destello - Sparkle - Éclat
12u resto - others - autres

24u color Oro - Gold - Or
24u color Plata - Silver - Argent
12u resto - others - autres



IA-096-001



1



IA-096-002



1



En superficies claras para un toque sutil.
In light surfaces for a subtle touch.
Dans les surfaces claires pour une touche subtile.



En superficies oscuras para un brillo intenso.
In dark surfaces to a high gloss.
Une haute brillance sur les surfaces foncées.





VERTIGO

Láminas de plástico de textura especial.

Special texture plastic sheets.

Feuilles en plastique de texture spécial.



Refleja y refracta la luz, creando deslumbrantes efectos visuales. Fuerte aunque fácil de cortar con tijeras, cizallas o troqueles. Se puede pintar o adornar con sellos y tintas de pigmento. Se puede repujar o troquelar con la mayoría de máquinas de repujado. Los modelos evocan espirales, burbujas, líneas u ondas.

Reflects and refracts light, creating dazzling visual effects. Sturdy yet easily cut with scissors or paper trimmer. Stamp or color with StazOn, Memento Luxe and other pigment inks can be embossed and die cut with most embossing machines. Patterns evoke swirls, bubbles, lines, or ripples.

Il réfléchit et réfracte la lumière, en créant des effets visuels éblouissants. Solide mais facile à découper avec des ciseaux ou des cisailles à papier. On peut le tamponner ou colorer avec StazOn, Memento Luxe et d'autres encres à pigments. Il peut être embossé et découpé avec la plupart des machines à embosser. Les motifs évoquent des spirales, bulles, lignes ou ondulations.



Breeze

VT-100-001

3 hojas 15x15cm - bolsa colgar
6" x 6" Pack of 3 - packaged
3 feuilles 15x15cm - sac accrocher

VT-007-001

1 hoja 30x30cm
12" x 12" Qty of 1
1 feuilles 30x30cm

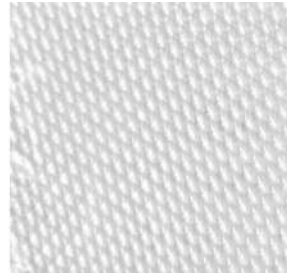

Prism

VT-100-004

3 hojas 15x15cm - bolsa colgar
6" x 6" Pack of 3 - packaged
3 feuilles 15x15cm - sac accrocher

VT-010-001

1 hoja 30x30cm
12" x 12" Qty of 1
1 feuille 30x30cm



Tilted

VT-100-002

3 hojas 15x15cm - bolsa colgar
6" x 6" Pack of 3 - packaged
3 feuilles 15x15cm - sac accrocher

VT-008-001

1 hoja 30x30cm
12" x 12" Qty of 1
1 feuilles 30x30cm



Pebbles

VT-100-005

3 hojas 15x15cm - bolsa colgar
6" x 6" Pack of 3 - packaged
3 feuilles 15x15cm - sac accrocher

VT-011-001

1 hoja 30x30cm
12" x 12" Qty of 1
1 feuille 30x30cm



Rattlesnake

VT-100-003

3 hojas 15x15cm - bolsa colgar
6" x 6" Pack of 3 - packaged
3 feuilles 15x15cm - sac accrocher

VT-009-001

1 hoja 30x30cm
12" x 12" Qty of 1
1 feuilles 30x30cm



Taffeta

VT-012-001

1 hoja 30x30cm
12" x 12" Qty of 1
1 feuille 30x30cm



Cortar con troqueles o tijeras.
Cut with scissors or dies.
Couper. avec des ciseaux ou des matrices.



Entintar con tintas.
Inking die.
Encre avec des encres.



Se puede realzar embossing encima del papel Vertigo.
Embossing can be done with Vertigo papers.
L'embossage peut être fait avec des papiers Vertigo.



SHEET Metal

Chapas de metal
Metal sheets
Feuilles métalliques



Packaging
Ref.

🛒 1



Metal fuerte pero ligero. Sin bordes afilados.

—
Sturdy yet lightweight metal.
No sharp edges.

—
Metal solide mais légère. Sans des bords coupants.



Círculos - Circles - Cercles

Pequeño - Small - Petit **MP-100-001**

25mm (1") - 20u

Grande - Large - Grand **MP-100-002**

32mm (1.25") - 20u



Círculos - Circles - Cercles

Pequeño - Small - Petit **MP-200-001**

25mm (1") - 20u

Grande - Large - Grand **MP-200-002**

32mm (1.25") - 20u



Rombos - Diamonds - Losanges

Pequeño - Small - Petit **MP-300-001**

25mm (1") - 20u

Grande - Large - Grand **MP-300-002**

32mm (1.25") - 20u



Óvalos - Ovals - Ouales

Pequeño - Small - Petit **MP-400-001**

19x29mm (0.75" x 1.125") - 20u

Grande - Large - Grand **MP-400-002**

26x38mm (1" x 1.5") - 20u



Placa identificación - Dog Tags

MP-600-005

Plaque identification

29x48mm (1.125" x 1.875") - 12u



Tarjeta ATC - ATC Cards - Carte ATC

MP-700-005

63x89mm (2.5" x 3.5") - 8u



Permite estampar con StazOn.
Allows stamping with StazOn.
Permet tamponner avec StazOn.



WALNUT INK

Para crear bonitos efectos de papel envejecido.
Creates beautiful aged paper effects.
Elle crée des beaux effets de papier vieilli.



Tonos pastel vintage y tonos tierra, perfectos para envejecer proyectos y dar otros efectos de tonos tierra. Ideal para utilizar con tintas permanentes de secado rápido VersaFine.

Vintage pastels and earth-tones, perfect for antiquing projects and other earth-toned effects. Ideal for use with quick drying, permanent VersaFine inks.

Teintes pastel vintage et teintes terre, parfaits pour vieillir des projets et pour d'autres effets de teintes terre. Elle est idéale pour utiliser avec des encres permanentes de séchage rapide VersaFine.

**Bote spray 59ml
38x38x16mm**
Spray bottle (.2 fl oz)
Pre-packaged size: 1.5" w x 1.5" d x 6.25" h
Bouteille spray 59ml 38x38x16mm



Spray 8ml	nogal	001
Spritzer 27 fl oz	café	002
Spray 8ml	terracota	003
	eucalipto	004
	flor cerezo	005
	envejecido	006
	sauce	007
	lila	008



**Polvo de tinta para disolver
Bote 57gr - Solo disponible en color 001**
Ink powder for dissolving
2 oz jar - Available in 001 color only.
Encre en poudre à dissoudre
Bouteille 57gr - Seulement disponible en couleur 001



WI-000- ...



6

WI-SML- ...



5

WI-INK-001



3

Set 96 sprays tinta + Display
Contiene 12 sprays de 8ml x color
96-piece Walnut Ink Spritzer
Set 12 each of all 8 Walnut Ink Spritzers
Set 96 sprays + Display
12 sprays de 8ml x 8 couleurs



WI-096-001



1



Set 2 sprays 8ml
Spritzer 2-packs 27 fl oz
Set 2 sprays 8ml



1

WI-SML-100

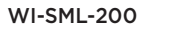

Set 4 botes spray 59ml - 14x35x16mm
4-pack Bottle Sampler 2 fl oz
5.625" w x 1.375" d x 6.25" h
Set 4 bouteilles spray 59ml
14x35x16mm



1



Sampler I
WI-100-004



Sampler II
WI-200-004

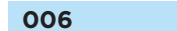

Pintar directamente con pincel.
Paint with brush.
Peindre directement avec la brosse.

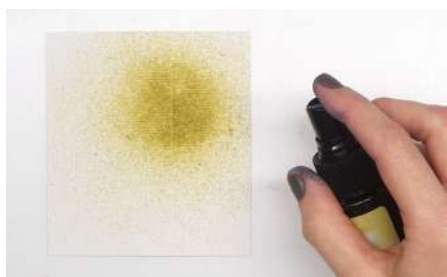

Directo al papel con spray.
Direct to paper with spray.
Directe au papier avec spray.



Spray directo con plantillas.
Direct spray with stencils.
Spray directe avec pochoirs.



DOODLESTIX



Un magnífico set de herramientas complementarias. Moldean, mueven, gravan y eliminan una gran variedad de materiales: Pastas, pinturas, arcillas y más. Se pueden utilizar sobre cualquier superficie. Ideales para añadir detalles personalizados y para aplicar color en zonas finas. Cada set contiene 5 estilos diferentes: Cincel ángulo, cincel taza, cincel redondo, cincel plano y punta cónica. La punta blanda de silicona es resistente a las manchas y se lava fácilmente.

A wonderful companion tool set for the expanding variety of exciting mediums now available. Shape, move, carve and remove a variety of wet materials: Pastes, paints, clays and more. Can be used on any surface (such as Craft Mat, Gelli Plate, and paper). Use to add custom details. Use to place color in fine areas. Each set contains 5 different styles: Angle chisel, Cup chisel, Cup round, Flat chisel, Taper point. Soft silicone tip is easily cleaned and resists staining.

Un magnifique ensemble d'outils complémentaires pour les croissantes et passionnantes techniques disponibles actuellement. Ils modèlent, remuent, taillent et enlèvent une variété de matériaux: Pâtes, peintures, argiles et plus. On peut les utiliser sur n'importe quelle surface. Ils sont idéals pour ajouter détails personnalisés et pour appliquer de la couleur sur des zones fines. Chaque set contient 5 styles différents : "Angle Chisel", "Cup Chisel", "Cup Round" "Flat Chisel" et "Taper Point". La pointe molle de silicone est facilement lavable et résistante au maculage.

CT-DOO-005
DoodleStix 5-pack



BRUSHTIX

Puntas de pincel de gomaespuma firme pero flexible. Utilízalos para aplicar suavemente tintas y técnicas para crear fondos artísticos homogéneos. Disponibles en dos medidas diferentes y 3 tipos de punta distintas. Lavables y reutilizables.

Firm yet flexible foam tip brushes. Use to smoothly apply inks and mediums to create seamless background art seamless background art. Available in two different sizes and three different brush tips. Washable and re-usable.

Pointes de pinceau de mousse firme mais flexible. Utilisez-les pour appliquer doucement des encres et techniques pour créer des fonds artistiques homogènes. Disponible dans deux tailles et 3 types de pointes différents. Lavables et réutilisables.



TÉCNICAS CON DOODLESTIX TECHNIQUES WITH DOODLESTIX TECHNIQUES AVEC DOODLESTIX



Utiliza DoodleStix con pintura o pastas para crear textura.
Use DoodleStix with paint or other wet mediums to create texture.
Utilisez DoodleStix avec des peintures ou pâtes.



Crema diseños sobre la alfombrilla de manualidades de Imagine Crafts.
Create designs on an Imagine Crafts Craft Mat.
Créez des designs sur le tapis d'Imagine Crafts.



Dibuja, escribe o garabatea para dar a los diseños con plantillas un interés extra.
Draw, write, or doodle in wet medium to give to stenciled images an extra interest.
Dessinez, écrivez ou gribouillez pour donner aux dessins au pochoir un interest extra,



Grava textura o diseños sobre pastas poliméricas.
Carve texture or designs in polymer clay.
Taillez des textures ou des dessins dans des pâtes polymériques.

PUNTA PINCEL - BRUSH TIP - POINTE PINCEAU



Punta pincel nº 2 (bolsa colgar)
Brush Tip #2 (packaged)
Pointe pinceau nº 2 (sac accrocher)

BX-100-002

Punta pincel nº 4 (bolsa colgar)
Brush Tip #4 (packaged)
Pointe pinceau nº 4 (sac accrocher)

BX-100-004

PUNTA DOMO - DOME TIP - POINTE DOMO



Punta domo nº 2 (bolsa colgar)
Dome Tip #2 (packaged)
Pointe domo nº 2 (sac accrocher)

BX-100-006

Punta domo nº4 (bolsa colgar)
Dome Tip #4 (packaged)
Pointe domo nº 4 (sac accrocher)

BX-100-008

PUNTA CINCEL - CHISEL TIP - POINTE CISEAU



Punta cincel nº 2 (bolsa colgar)
Chisel Tip #2 (packaged)
Pointe ciseau nº 2 (sac accrocher)

BX-100-010

ALFOMBRILLA MANUALIDADES
 IMAGINE CRAFTS CRAFT MAT
 TAPIS MANUALITÉES



CR-PKG-001

38x46cm



ACCESORIOS PARA TINTAS
 INK ACESSORIES KIT
 KIT D'ACCESSOIRES POUR ENCRE

Contiene una variedad de accesorios para crear coloridos y divertidos efectos.
 Contains a variety of accessories to create colorful and fun effects.
 Il contient une variété d'accessoires pour créer des effets colorés et amusants.



IS-000-001



FANTASTIX



La herramienta multiusos perfecta para colorear. Utilízala para crear rotuladores de tinta multiusos.

The perfect multi-purpose coloring tool. Use to create All-Purpose ink markers.

L'outil à usages multiples parfait pour colorer. Utilisez-le pour créer marqueurs d'encre à usages multiples.



Punta pincel
 Brush Tip Pack
 Pointe pinceau

FX-100-006

Punta redonda
 Bullet Tip Pack
 Pointe ronde

FX-200-006

TAPONES APLICADOR
 Se fijan fácilmente a los bote de tinta Walnut Ink para una aplicación más controlada.

APPLICATOR CAPS
 Attaches easily to the Walnut Ink bottles for more controlled application

BOUCHONS APPLICATEURS
 Ils s'attachent facilement aux bouteilles d'encre Walnut pour une application plus contrôlée.



AC-000-004

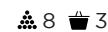

BOTES VACÍOS - EMPTY BOTTLES - BOUTEILLES VIDES

Bote aplicador esponja vacío
 Empty dauber top bottle
 Bouteille applicateur éponge vide

60ml



AB-000-006



Bote para polvo embossing vacío
 Empty Embossing Powder jar
 Pot pour poudre embossing vide

30ml



AB-000-007



Bote cánula punta fina vacío
 Empty pico bottle
 Bouteille canule pointe fine vide

30ml



AB-000-009



CUENTAGOTAS PARA TINTA
 INK DROPPERS
 COMPTE-GOUTTERS POUR ENCRE



ID-000-025



Acuarelar
 Watercolor
 Aquareller



Estampar
 Stamp
 Tamponner



Pulverizar
 Spray
 Pulvériser



moment

CINTA MASKING & WASHI TAPE

MASKING & WASHI TAPE

BANDE MASKING & WASHI

Cinta adhesiva de papel de arroz* que se usa como complemento decorativo.

Sus dos principales características son que se puede cortar con las manos y se puede escribir encima.

Puede ser reposicionada sin dañar la superficie en que se trabaja. Muy versátil y divertida.

Tiene infinidad de aplicaciones como forrar libros, decorar objetos, envolver regalos, etc.

Las cintas adhesivas washi de la serie metal tienen una última capa foil que les da un acabado brillante.

* Las cintas adhesivas de la Serie Glitter no están fabricadas con papel de arroz washi. Sin ácido y sin lignina.

Rice washi paper tape* used as a decorative complement.

The two main features are that it can be cut with the hands and it can be written on.

Removable without harming the surface where we are working on. Really versatile and funny.

It has countless applications such as covering books, decorating objects, wrapping presents, etc.

Masking tapes of Metal Collection have a last foil layer that gives them a shiny finish.

* Masking tapes of Glitter Collection are not made of rice paper (washi). Acid and lignin free.

Ruban adhésif de papier de riz* qui s'utilise comme complément décoratif.

Ses deux principales caractéristiques sont que nous pouvons les couper avec les mains et y écrire dessus.

Possibilité d'être remise en place sans endommager la surface où l'on y travaille.

Très versatile et amusante.

Possède une infinité d'applications comme couvrir livres, décorer objets, envelopper des cadeaux, etc.

Les rubans adhésifs washi de la Série Métal ont une dernière couche foil qui leur donne une finition brillante.

* Les rubans adhésifs de la Série Glitter ne sont pas fabriqués avec papier de riz washi.

Sans acide et lignine.



MASKING TAPE - SERIE GLITTER



Packaging Ref.
15mmx6,5m
1
5



Packaging Ref.
6
1



17470
plateado
silver
argenté



17471
azul
blue
bleu



17472
rojo
red
rouge



17473
negro
black
noir



17474
verde
green
vert



17475
dorado
gold
doré



set
17503
6



MASKING TAPE - SERIE BÁSICOS



Packaging Ref.
15mmx10m
1
5



Packaging Ref.
10
1



17423
verde claro
light green
vert clair



17424
verde
green
vert



17425
verde pistacho
pistachio green
vert pistache



17426
amarillo
yellow
jaune



17427
naranja
orange
orange



17428
carne
flesh-colored
couleur chair



17429
negro
black
noir



17430
azul claro
light blue
bleu clair



17431
rojo
red
rouge



17432
lila
purple
violet



17510
10





MASKING TAPE FOIL - SERIE METAL



Packaging Ref.

15mmx10m

1
5



Packaging Ref.

6
1



17400
topos rosa
dots pink
points rose



17401
plateado
estrellas
silver stars
étoiles argenté



17406
plateado lineas
silver strips
bandes argenté



17407
dorado lineas
gold strips
bandes doré



17402
flores rosa
pink flowers
fleurs rose



17403
arabesco rosa
pink arabesque
arabesque rose



17408
dorado zig-zag
gold zig-zag
zig-zag doré



17409
dorado flechas
gold arrows
flèches doré



17404
formas rosa
pink shapes
formes rose



17405
estrellas rojo
red stars
étoiles rouge



17410
plateado
silver
argenté



17411
dorado
gold
doré



set

17500

6



set

17501

6

MASKING TAPE - SERIE DECO



Packaging Ref.

15mmx10m

1
5



Packaging Ref.

10
1



17433
pata de gallo rojo
red houndstooth
pied-de-poule
rouge



17434
zig zag rojo
zig zag rouge
red zig zag



17435
flores rojas
red flowers
fleurs rouges



17436
ribete estrellas
rojo
stars red trim
liseré rouge
étoiles



17437
escamas verde
green flakes
flocons verts



17438
flores verdes
green flowers
fleurs vertes



17439
lineas marro-
nes-verdes
brown-green
stripes
bandes mar-
ron-vert



17440
pájaros negros
black birds
oiseaux noirs



17441
huellas pies
footprints
empreintes



17442
topos negros
black dots
points noirs



set

17511

10



MASKING TAPE - SERIE ULTRAMAR



Packaging Ref.
15mmx10m
1
5



Packaging Ref.
10
1



17443
azul
blue
bleu



17444
pájaros azul
birds blue
bleu oiseaux



17445
barcos azul
boats blue
bateaux bleu



17446
cuadrados azul
squares blue
carrés bleu



17447
flores azul
flowers blue
fleurs bleu



17448
ancla azul
blue anchor
ancre bleu



17449
zig zag azul
zig zag blue
zig zag bleu



17450
flores azul
flowers blue
fleurs bleu



17451
flores y lazos lila
flowers and
bows lilac
fleurs-rubans
lilac



17452
ribete lila
lilac trim
liseré lilac



17512
10

MASKING TAPE - SERIE FLORAL



Packaging Ref.
15mmx10m

1
5



Packaging Ref.

10
1



17453
rayas colores
colorful stripes
bandes colorées



17454
arabescos rojo
red arabesques
arabesques rouges



17455
trébol
clover
trèfle



17456
flores rojas-rosas
red-pink flowers
fleurs rouges-roses



17457
flores naranjas
orange flowers
fleurs oranges



17458
garabatos
scrawl
gribouillage



17459
media naranja
half orange
demi-orange



17460
rosa con topos
dots pink
rose à pois



17461
rosa corazón
heart rose
coeur rose



17462
deco



17513
10



MASKING TAPE FOIL - SERIE TUTTI FRUTTI



Packaging Ref.
15mmx10m
1
5



Packaging Ref.
6
1



17412
verde y flores rosas
green and pink roses
fleurs vertes et roses



17413
piñas
pineapples
ananas



17414
flechas azules
blue arrows
flèches bleues



17415
zig zag rosas
pink zig zag
rose zig zag



17416
rosa con topos
spots pink
rose à pois



17417
rosa con rayas
pink with stripes
rose avec rayures



set

17502
6



DISPENSADOR APILABLE

—
STACKABLE DISPENSER

—
DISPENSATEUR EMPILABLE



Packaging
Ref.

1

Ideal para organizar tus Masking Tapes, es apilable y ofrece dos tamaños de corte en zig-zag.

—
Ideal for organizing your Masking Tapes, is stackable and offers two zigzag cut sizes.

—
Parfait pour organiser vos Masking Tapes. Peut s'empiler et propose deux tailles de coupe zigzag.



+i



101274

10,5x9x6,7cm



Corte intercambiable
Interchangeable cut
Coupe interchangeable



Apilable
Stackable
Peut s'empiler



Fácil reposición
Easy replenishment
Simple reposition



CINTA MASKING & WASHI TAPE CLASSIKY'S

MASKING & WASHI TAPE CLASSIKY'S

BANDE MASKING & WASHI CLASSIKY'S



Packaging Ref.



Packaging Ref.



CLASSIKY'S es una fábrica de papel tradicional japonesa. Todos sus productos son de primera calidad, están fabricados con técnicas de papelería ancestral y sus diseños, realizados por los mejores diseñadores del momento, evocan la naturaleza y la historia japonesa.

INNSPIRO es distribuidor exclusivo de las cintas adhesivas Washi de CLASSIKY'S.

Están hechas de papel de arroz y su calidad es extraordinaria, con ellas podrá realizar preciosas y originales decoraciones.

CLASSIKY'S is a Japanese traditional paper factory. All its products are top quality and made with ancestral stationery techniques. Its designs, which are created by the current best designers, recall nature and Japanese history.

INNSPIRO is the exclusive distributor of CLASSIKY'S washi masking tapes. They are made with rice paper and their quality is extraordinary. You will create beautiful and original ornaments with them.

CLASSIKY'S est une usine de papier traditionnelle japonaise. Tous ses produits sont de premier qualité et faites avec des techniques de papeterie ancestrales. Ses dessins, qui sont créés par les meilleurs designers du moment, évoquent la nature et l'histoire du Japon.

INNSPIRO est le distributeur exclusif des rubans adhesives washi de CLASSIKY'S. Elles sont faites de papier de riz et leur qualité est extraordinaire. Avec eux, vous pourrez réaliser de décorations magnifiques et originales.



DIS831

120 unidades

30 modelos x 4 unidades

17'5x15x35'5cm





SERIE YONAGADO

15mm x 15m  1



CL26338-04



CL26338-05



CL26338-06



CL26338-10



CL26338-11



CL26338-12

set

15mm x 15m  1



CL26336-01



CL26336-02



CL26336-03



CL26336-04



CL26337-01



CL26337-02



CL26337-03



CL26337-04



CL26337-05



CL26337-06





SERIE TEN TO SEN

15mm x 15m 1



CL26533-05



CL26533-07



CL26533-08



CL26533-11



CL26533-12



CL26534-01



CL26534-02



CL26534-04



CL26534-05

set

15mm x 15m 1



CL26531-01



CL26531-02



CL26531-03



CL26531-04



CL26532-01



CL26532-02



CL26532-03



CL26532-04



CL26532-05



CL26532-06





SERIE ZWILINGE

18mm x 15m 🛒 1

30mm x 15m 🛒 1

set

30mm x 15m 🛒 1



CL29129-01



CL29130-01



CL29117-01



CL29129-02



CL29130-02



CL29117-02



CL29129-03



CL29130-03



CL29117-03

18mm x 15m 🛒 1

30mm x 15m 🛒 1



CL29131-01



CL29131-02



CL29131-03



CL29132-01



CL29132-02



CL29132-03

set

30mm x 15m 🛒 1



CL29120-01



CL29120-02



CL29120-03

SERIE ZWILINGE

10mm x 15m 🛒 1

15mm x 15m 🛒 1

24mm x 15m 🛒 1

set

24mm x 15m 🛒 1



CL29134-01



CL29135-01



CL29136-01



CL29123-01



CL29134-02



CL29135-02



CL29136-02



CL29123-02



CL29134-03



CL29135-03



CL29136-03



CL29123-03

10mm x 15m 🛒 1

15mm x 15m 🛒 1

24mm x 15m 🛒 1

set

24mm x 15m 🛒 1



CL29137-01



CL29138-01



CL29139-01



CL29126-01



CL29137-02



CL29138-02



CL29139-02



CL29126-02



CL29137-03



CL29138-03



CL29139-03



CL29126-03



SERIE ZWILINGE

15mm x 15m 1



1





SERIE TORINOKO

15mm x 15m 🛒 1



CL29926-01

CL29926-02

CL29926-03

18mm x 15m 🛒 1



CL29926-07

CL29926-08



CL29926-05

CL29926-06

set

15mm x 15m 🛒 1



CL29927-01



CL29927-02



CL29927-03



CL29927-04



SERIE YOKO INOUE

15mm x 15m 🗑️ 1



CL45203-01



CL45203-05



CL45203-06

set

15mm x 15m 🗑️ 1

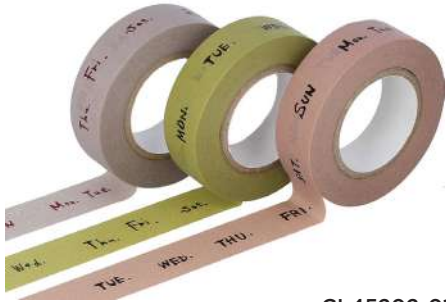

CL45202-01



CL45202-02



CL45202-03

22mm x 15m 🗑️ 1



CL45204-01



CL45204-02



CL45202-04

SERIE MIHOKO SEKI

8mm x 15m 🗑️ 1



CL45322-07

15mm x 15m 🗑️ 1



CL45322-08

set





SERIE MIHOKO SEKI

set

15mm x 15m 🛒 1



CL45322-01



CL45322-03



CL45322-05

24mm x 15m 🛒 1



CL45322-02



CL45322-04



CL45322-06

20mm x 15m 🛒 1



CL45321-16



CL45321-17



CL45321-18

22mm x 15m 🛒 1



CL45321-10



CL45321-11



CL45321-12



CL45321-04



CL45321-05



CL45321-06

15mm x 15m 🛒 1



CL45028-01 CL45028-02 CL45028-03



CL45012-01



CL45012-02



45mm x 15m 🛒 1

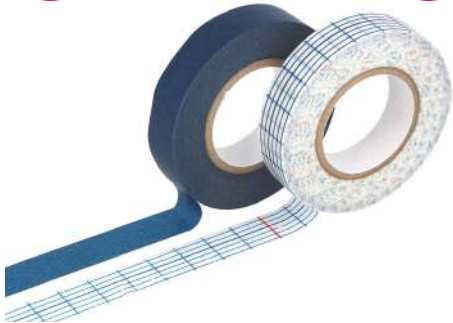

CL45017-01



CL45017-07



CL45017-08



CL45026-01



CL45026-02



CL45026-03



CL45026-04



CL45027-02





MASKING & WASHI TAPE

Cinta adhesiva de papel de arroz en diferentes estampados.

Rice paper tapes in different patterns.

Ruban adhésif de papier riz en multiples imprimés.



Packaging Ref.

15mmx10m

2
2



DMT2S06



DMT2S07

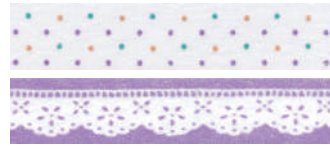

DMT2S08

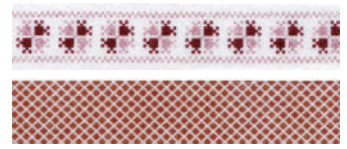

DMT2S10



DMT2S12



DMT2S14



DMT2S15



DMT2S18

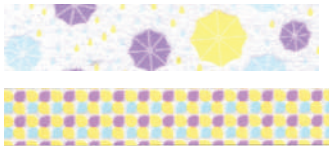

DMT2S21



DMT2S22



DMT2S23



DMT2S24

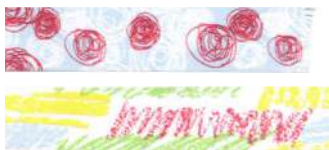

DMT2S26



DMT2S31



DMT2S33



DMT2S34



DMT2S36



DMT2S38



DMT2S39



DMT2S40



DMT2S41





DMS01



DMS02



DMS03



DMS04



DMS09



DMS05



DMS06



DMS07

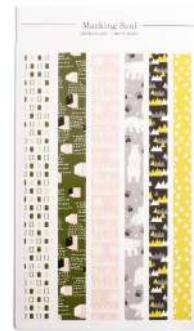

DMS08



DMS10

ETIQUETAS ADHESIVAS PIEL SINTÉTICA · SYNTHETIC LEATHER STICKERS · STICKERS EN CUIR SYNTHÉTIQUE

6x4,7cm 🧺 14 🛒 2



DTC01



DTC02



DTC03



DTC04



DTC05

ETIQUETAS PAPEL · PAPER STICKERS · STICKERS EN PAPIER

3,5x5,1cm 🧺 108 🛒 2



DPSV01



DPSV02





PAPEL PARA ENVOLVER · WRAPPING PAPER · PAPIER D'EMBALLAGE

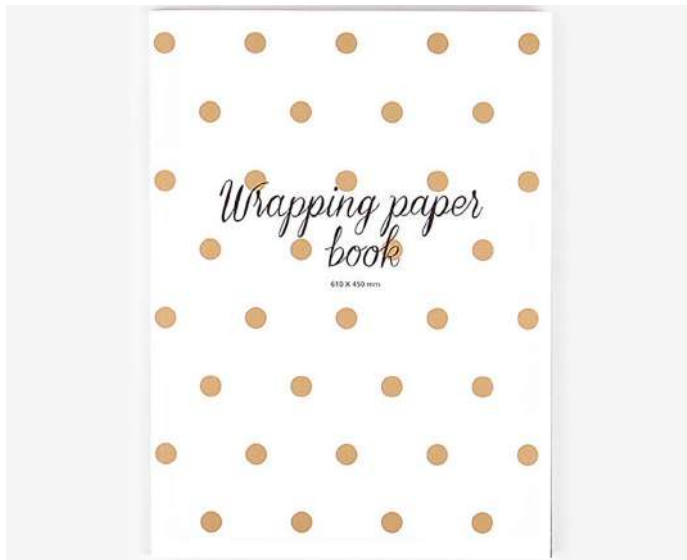

20 2

DWPB01

Cubierta: 225x305mm
Interior: 450x610mm



COLECCIÓN PAPELES · PAPER COLLECTION · COLLECTION PAPIERS



36 2

DCP03

16 modelos x 2
44x30cm

PEGATINAS PAPEL · PAPER STICKERS · STICKERS EN PAPIER



6 2

DPS09

11,6x15,3cm



7x12cm 2 3



DASS03



DASS04



DASS05



DASS06



DASS08



DASS10



DASS11



DASS12



DASS13



DASS14



DASS15



DASS16



DASS17



DASS18



DASS19



DASS20



DASS21



DASS22



DASS23



DASS24



DIS801

126 unidades
21 modelos x 6 unidades
17'5x15x35'5cm

Ø8,5mm  42  2



DSTC01



DSTC02



DSTC03



DSTC04



DSTC05



DSTC06



DSTC07



DSTC08



DSTC09



DSTC10



DSTC11



DSTC12



DSTC13



DSTC14



DSTC15



DSTC16

EXPOSITORES · DISPLAYS · PRESENTOIRS

DIS802 - 120 unidades
 DIS802-B - 120 unidades
 30 modelos x 4 unidades
 17'5x15x35'5cm





ADHESIVOS REDONDOS · ROUND STICKERS · ADHÉSIVES RONDES

Ø8,5mm 42 2



DSTC17



DSTC18



DSTC19



DSTC20



DSTC21



DSTC22



DSTC23



DSTC24

PEGATINAS PAPEL · PAPER STICKERS · STICKERS EN PAPIER

4 2



DSTC31
Ø11mm



DSTC32
Ø11mm



DSTC33
Ø11mm



DSTC34
Ø11mm



DSTC35
Ø11mm



DSTC36
Ø11mm

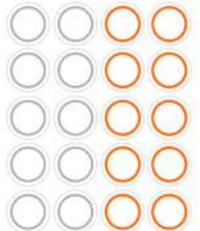

DSTC37
Ø14mm

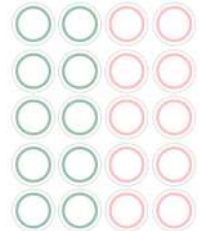

DSTC38
Ø14mm

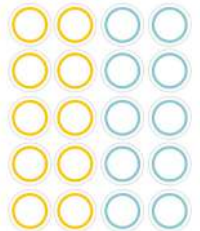

DSTC39
Ø14mm

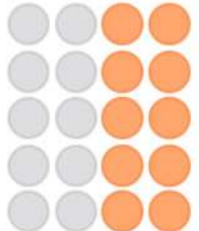

DSTC40
Ø14mm

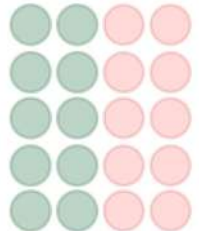

DSTC41
Ø14mm

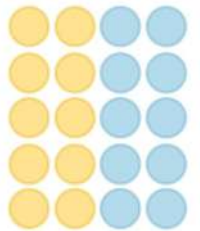

DSTC42
Ø14mm

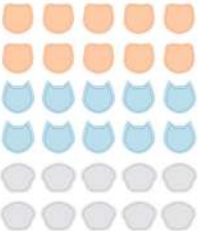

DSTC43
Ø9mm

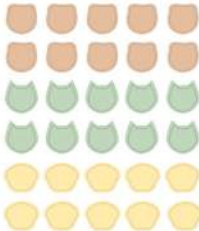

DSTC44
Ø9mm



DSTC45
Ø9mm



DSTC46
Ø8mm



DSTC47
Ø8mm



DSTC48
Ø8mm

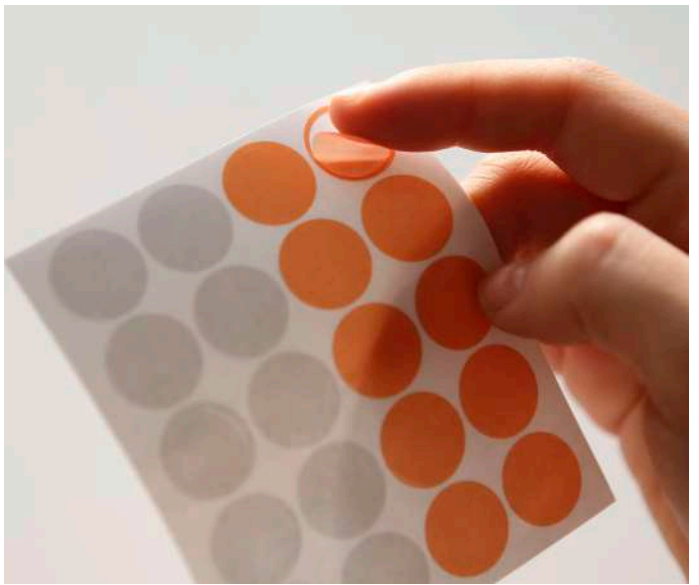



PEGATINAS PAPEL · PAPER STICKERS · STICKERS EN PAPIER

4 2

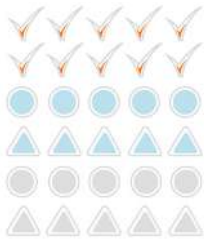

DSTC49
Ø8,5mm

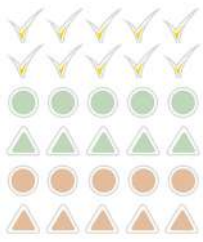

DSTC50
Ø8,5mm

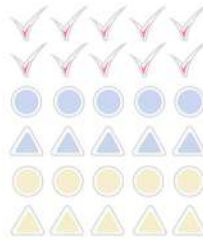

DSTC51
Ø8,5mm



DSTC52
Ø8,5mm



DSTC53
Ø8,5mm



DSTC54
Ø8,5mm

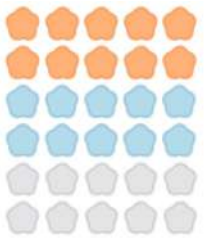

DSTC55
Ø10mm

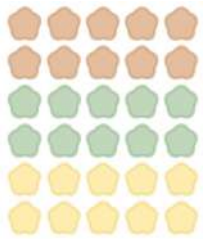

DSTC56
Ø10mm



DSTC57
Ø10mm



DSTC58
Ø10mm



DSTC59
Ø10mm

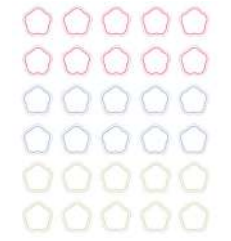

DSTC60
Ø10mm

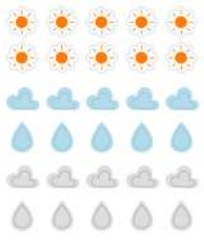

DSTC61
Ø10mm

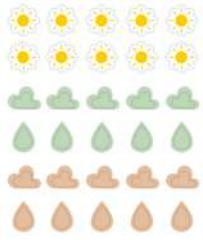

DSTC62
Ø10mm



DSTC63
Ø10mm



DSTC64
Ø10mm



DSTC65
Ø10mm



DSTC66
Ø10mm



9x18,5mm 1 2



DPS10



DPS11



DPS12



DPS13



DPS14



DPS15



DPS16



DPS17



DPS18



DPS19



DPS20



DPS21



DPS22



DPS23

12x17cm 1 2



DPS24



DPS25



9x18,5mm 1 2



DPS26



DPS27



DPS28

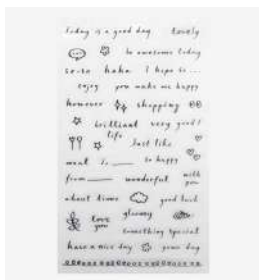

DPS29

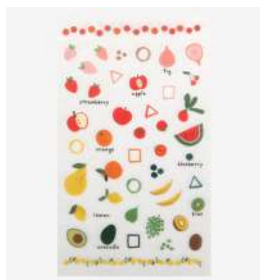

DPS30

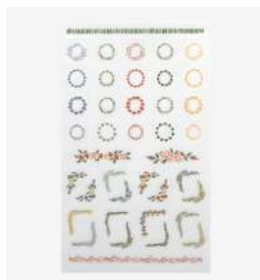

DPS31



DPS32



DPS33



DPS34

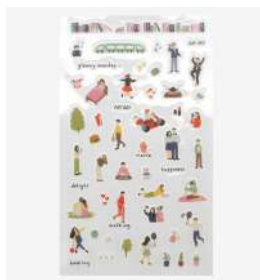

DPS35



DPS36



DPS37



DPS38



DPS39



DPS40



DPS41



DPS42

DIS803

84 unidades
14 modelos x 6 unidades
38x15x35'5cm



DPS43





DFP01
200x175mm



DTS01
120x170mm



DTS02
120x170mm - 50mm



DTS03
20mm - 30mm



DTS04
10,8x15,5mm



DTS05
10,8x15,5mm



DTS06
10,8x15,5mm



DTS07
10,8x15,5mm



DTS08
10,8x15,5mm



DTS09
10,8x15,5mm



DTS10
10,8x15,5mm



DTS12
10,8x15,5mm



DTS13
10,8x15,5mm



DTS15
10,8x15,5mm



ADHESIVOS CON RELIEVE · EMBOSSED STICKERS · STICKERS EN RELIEF

9,8x13,5mm 2 2



DEMS01
01 GOLD SEAL



DEMS02
02 SILVER SEAL



DEMS03
03 BRONZE SEAL



ETIQUETAS PRECORTADAS · PRECUT TAGS · ÉTIQUETTES PRÉDÉCOUPÉES

15x21cm 2 2



DGIT02



DGIT03



DGIT04

TARJETA PRECORTADAS · PRECUT GIFT · CARTE PRÉDÉCOUPÉES

12x11,5cm 5



DLGAC01
9,3x21,3cm



DLGAC02
8x21,3cm



DLGAC03
10x21,3cm



DLGAC04
11x20,3cm





BOLSA PAPEL · PAPER BAGS · SACHETS EN PAPIER

15x27x9cm 🍷 10 🛒 2



DPPB03



DPPB05



DZB02

Craft zipper bag - L
19,5 x 27 cm - Set 3u.



DPLB02

Plain paper bag - White
15 x 27 x 9 cm - Set 10u.

SOBRES ESTAMPADOS · GIFT BAG · ENVELOPPES IMPRIMÉS

16,5x25cm 🍷 3x2 🛒 1



DGB01

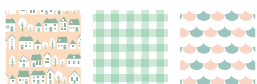

DGB02



DGB03



DGB04



DGB05



DGB06



DGB07



SOBRES PLASTICO TRANSPARENTES · CLEAR GIFT BAGS · ENVELOPPES EN PLASTIQUE TRANSPARENT

Cierre adhesivo · Sticky flap · Rabat autocollant

🍷 10 🛒 2



DSBS03
10 x 11 cm



DSBM01
13 x15 cm



DSBM02
13 x 15 cm



DSBM03
13 x15 cm

CARTAS DE PAPEL ESTAMPADO CON SOBRE · STAMPED PAPER LETTERS WITH ENVELOPE
PAPIER ESTAMPÉ LETTRE AVEC ENVELOPPE

13x19cm (14x10cm) 📄 5



DLGAC06



DLGAC07



DLGAC08



DLGAC11



DLGAC12



DLGAC13



DLGAC14



DLGAC15



DLGAC16



DIS813

48 unidades
6 modelos x 8 unidades
17'5x15x35'5cm



TARJETA ÁLBUM · ALBUM CARD · CARTE ALBUM

16,2x11,2cm 🗑 5

Contiene 4 plásticos con capacidad para 8 fotos 4x6 (10x15cm) | Espacio para escribir un mensaje en el interior de la tarjeta. Incluye funda semitransparente.

4 photo plastic bags for 8 pictures of 4x6 (10x15cm) included | Space for writing a message inside the card. Semi-transparent envelope included.

Elle contient 4 pochettes en plastique pour 8 photos de 4x6 (10x15cm) | Espace pour écrire un message à l'intérieur de la carte. Enveloppe semi-transparent incluse.



DLC01



DLC02



DLC03



DLC04



DLC05



DLC06



DLC07

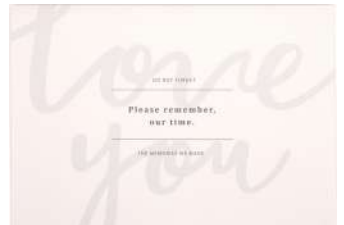

DLC08



DIS807

48 unidades

8 modelos x 6 unidades

38x15x35'5cm



10x15cm  5



DAC85



DAC86



DAC87



DAC88



DAC89



DAC90



DAC91



DAC92



DAC93



DAC94



DAC95



DAC96



DAC97



DAC98



DAC99



DAC100

DIS809

160 unidades

16 modelos x 10 unidades

38x15x35'5cm

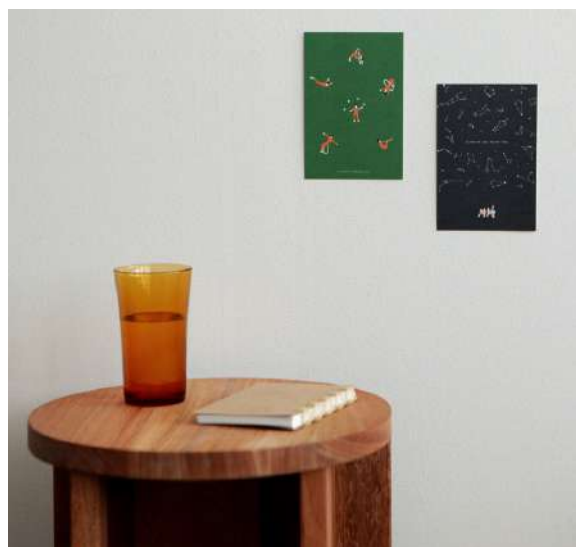

10x14,8cm 5



DAC07



DAC08

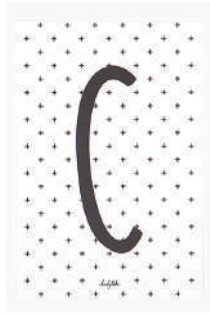

DAC09



DAC10



DAC11



DAC12



DAC13



DAC14



DAC15



DAC16



DAC17



DAC18



DAC19



DAC20



DAC21



DAC22

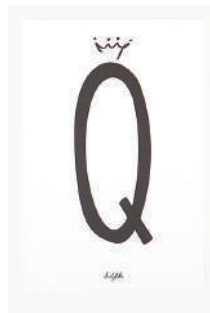

DAC23



DAC24



DAC25



DAC26



DAC27



DAC28



DAC29



DAC30



DAC31



DAC32





TARJETA POSTAL ALFABETO · ALPHABET POST CARD · CARTES ALPHABET

10x14,8cm 5



DAC36



DAC37



DAC38



DAC39



DAC40



DAC41



DAC42



DAC43



DAC44



DAC45



DAC46

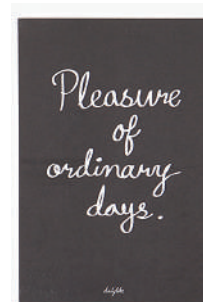

DAC33



DAC34



DAC47



DAC35
SET (A-Z)



DAC48
SET - (1-0)

DIS804

160 unidades

40 modelos x 4 unidades

38x15x35'5cm



TARJETAS POP-UP · CARDS · CARTES

11x11cm (11,7x11,7cm) 🛒 5



DAC109



DAC110



DAC111



DAC112



DAC113



DAC114



DIS810

36 unidades

6 modelos x 6 unidades

38x15x35'5cm



TARJETAS CON VENTANA Y SOBRE · WINDOW CARDS AND ENVELOPE · CARTES DE FENÊTRE ET EVNELOPPE

11x11cm (11,7x11,7cm) 🛒 5



DAC115



DAC116



DAC117



DAC118



DAC119



DAC121



DAC122

DIS812
56 unidades
7 modelos x 8 unidades
38x15x35'5cm





TARJETAS NAVIDAD CON VENTANA Y SOBRE · CHRISTMAS CARDS WITH WINDOW AND ENVELOPE
 CARTES DE NOËL AVEC FENÊTRE ET ENVELOPPE

10x14cm (10x14,5cm) 🗑️ 5

DIS811

48 unidades

8 modelos x 8 unidades

38x15x35'5cm



DAC101



DAC102



DAC103



DAC104



DAC105



DAC106



DAC107



DAC108



TARJETAS CON MENSAJE · MESSAGE CARDS · CARTES AVEC MESSAGE

9,5x13cm (10,5x14cm) 🛒 5



DNC01



DNC02



DNC03



DNC04



DNC05



DNC06



DNC07



DNC08



DNC09



DNC10



DNC11



DNC12



DNC13



DNC14

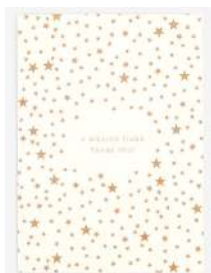

DNC15



DNC16

DIS806

64 unidades
16 modelos x 4 unidades
38x15x35'5cm



13x9,5cm (13,5x10cm) 🛒 5



DMC01



DMC02



DMC03



DMC04



DMC05



TARJETAS CON MENSAJE · MESSAGE CARDS · CARTES AVEC MESSAGE

13x9,5cm (13,5x10cm) 🗑️ 5



DAC50



DAC51



DAC52



DAC53



DAC54



DAC55



DAC56



DAC57



DAC58



DAC59



DAC60



DAC61



DAC62



DAC63



DAC64



DAC65



DAC66



DAC67



DAC68

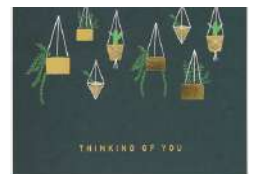

DAC69



DAC70



DAC71



DAC72



DAC73



DAC74



DAC75



DAC76



DAC77



DAC78



DAC79



DAC80



DAC81



DAC82



DAC83



DAC84

DIS805

108 unidades

38 modelos x 3 unidades

38x15x35'5cm



9,7x7cm (10x7,5cm) 🗑️ 5



DFC01



DFC02



DFC03



DFC04



DFC05



DFC06



DFC07



DFC08



DFC09



DFC10



DFC11



DFC12



DFC13



DFC14



DFC15



DFC16



DFC17



DFC18



DFC19



DFC20

DIS808

80 unidades

20 modelos x 4 unidades

17,5x15x35'5cm





CINTA ADHESIVA TEXTIL

FABRIC TAPE

RUBAN TISSU ADHÉSIF



Packaging Ref.

15mm x 5m

1
2



Packaging Ref.

15mm x 5m

3
2

15mm x 5m  2



DFTS01



DFT010



DFTD06



DFTD07



DFTD08



DFTD09



DFTD10



DFTS21



DFTS22



DFTS23



DFTS24



DFTS25



DFTS26



DFTS30



DFTS33



DFTS14



DFTS16



DFTS17



DFTS18



DFTS19



CINTA ADHESIVA TEXTIL · FABRIC TAPE · RUBAN TISSU ADHÉSIF

15mm x 5m 2



DFTS20



DFTD03



DFTC03



DFTF06



DFTF10



DFTS03



DFTS04



DFTC05



DFTC07

set

15mm x 5m 3 1



DFT2S02



DFT3S01



DFT3S03



DFT3S06



DFT3S07



DFT3S10



DFT3S11



DFT3S12



DFT3S14



DFT3S15



DFT3S16



DFT3S17



DFT3S18



DFT3S20



DFT3S21



DFT3S22



DFT3S23



DFT3S24



DFT3S25



DFT3S26



set

15mm x 5m 3 1



DFT3S28



DFT3S29



DFT3S30



DFT3S31



DFT3S32



DFT3S33



DFT3S35



DFT3S36



DFT3S37



DFT3S38



DFT3S39



DFT3S40



DFT3S41



DFT3S42



DFT3S43



DFT3S44



DFT3S45



DFT3S46



DFT3S47



DFT3S48



DFT3S49





HOJA ADHESIVA TEXTIL

FABRIC STICKER

FEUILLE TISSU ADHÉSIF



Packaging Ref.

210 x 297mm

2



DFSF04



DFSF06



DLFS04



DLFS07



DLFS08



DLFS09



DLFS33



DLFS36



DLFS38



DLFS41



DLFS45



DLFS51



DLFS52

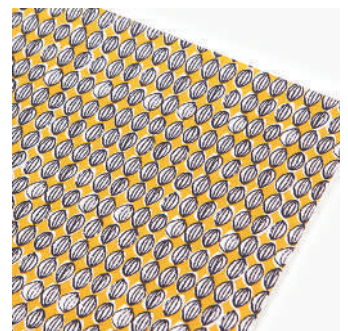

DLFS53

210x297mm 🗑️ 2



DLFS55



DLFS56



DLFS57



DLFS60



DLFS63



DLFS62



DFLF04



DFLF07



DFLF09



DLFS65



DLFS66



DLFS67



DLFS68



DLFS69



DLFS70



DLFS71



DLFS72



210x297mm  2



DLFS73



DLFS74



DLFS75



DLFS76



DLFS77

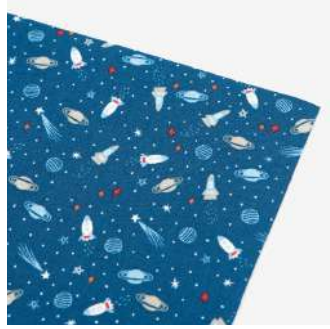

DLFS78



DLFS79



DLFS80



DLFS81



DLFS82



DLFS83



DLFS84



DLFS85



DLFS86



DLFS87



DLFS88



DLFS89

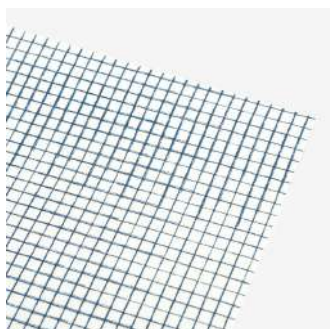

DLFS90



DLFS91





210x297mm  3  1



DFS3S19

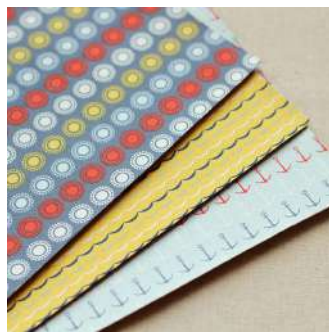

DFS3S21



DFS3S24



DFS3S25



DFS3S29



DFS3S30



DFS3S31



DFS3S36



DFS3S38





CINTAS DECORATIVAS

—
DECORATIVE RIBBONS

—
RUBANS DÉCORATIFS

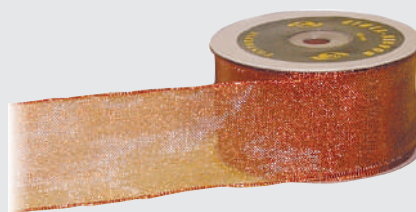

Packaging
Ref.

⊙ 10m

🗑 1

Cintas decorativas con variedad de colores, estampados y grosores. Con hilo metálico por lado para hacer lazos con más facilidad manteniendo la forma deseada.

—
Decorative ribbons with variety of colors, prints and thicknesses. With wire on each side to make loops more easily getting the desired shape.

—
Rubans décoratifs avec une variété de couleurs et d'épaisseurs. Avec un fil métallique de chaque côté pour faire des boucles plus facilement d'obtenir la forme désirée.



30100
3,5cm

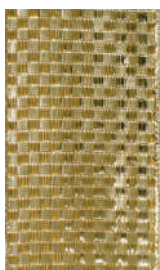

30101
3,5cm



30102
3,5cm



30120
6,5cm



30220
6,5cm



30230
6,5cm



30240
6,5cm



30130
6,5cm



30131
6,5cm



30190
6,5cm



30170
6,5cm



30171
6,5cm



30195
6,5cm



30160
6,5cm



30210
6,5cm



30140
6,5cm



30141
6,5cm



30142
6,5cm



30122
6,5cm



30152
6,5cm



30153
6,5cm



30080
4cm



30081
4cm



30082
4cm



30083
4cm



30084
4cm



30091
4cm



30095
4cm



30110
4cm



30111
4cm



30112
4cm



30113
4cm



30114
4cm



30115
4cm



30116
4cm



30020 30021
1cm 4cm



30022
6,5cm



30118
4cm



30070
4cm



30071
4cm



30030
4cm



30031
4cm



30057
3cm



30200
6,5cm



30052
6,5cm



30060
4cm



30061
4cm



30062
4cm



30063
4cm





GOMA ELÁSTICA
—
ELASTIC RUBBER
—
BANDE ÉLASTIQUE



**Packaging
A + Ref.**

⊙ 3m
🛒 5



**Packaging
Ref.**

⊙ 350m
🛒 1

GOMA ELÁSTICA · ELASTIC RUBBER · BANDE ÉLASTIQUE

Gran selección de gomas elásticas de diferentes colores, con su tejido en ligero canalé en horizontal es la denominada suave o blanda perfecta para trabajos que no necesiten mucha tensión. Ideal para que no marquen o aprieten en exceso, su tensión es óptima para costura, mascarillas, máscaras y manualidades infantiles.

Se completa con todos los accesorios necesarios para tus mascarillas diy.

A large selection of different coloured elastic bands, with their fabric in light horizontal ribbing, is the so-called soft band, perfect for work that does not require much tension.

Ideal for not marking or tightening too much, its tension is optimal for sewing, masks, masks and children's crafts.

It comes complete with all the accessories needed for your diy masks.

Grande sélection d'élastiques de différentes couleurs, avec tissu de canalé en horizontal délicat ou mou pour un travail qui n'a pas besoin d'avoir une grande tension.

Ces élastiques sont parfaits car ils ne serrent pas et ne marquent pas. Tension optimale pour couture, masques et pour des manualités enfants.

Se complète avec tous les accessoires nécessaires pour vos masques DIY.

🛒	5	🛒	1
⊙	3m	⊙	350m
— —	5,3mm	— —	5,3mm

	A40500	40500
	A40501	40501
	A40502	40502
	A40503	40503
	A40504	40504
	A40505	40505
	A40506	40506
	A40507	40507
	A40510	40510
	A40511	40511
	A40512	40512





GOMA ELÁSTICA · ELASTIC RUBBER · BANDE ÉLASTIQUE



set
60%
POLY.
40%
LÁTEX



6 assorted colours

A40520



negro · black · noir

E4147-2-BL

1
Ø 2mm



blanco · white · blanc

E4147-2-W

1
Ø 2mm



negro · black · noir

E4942-BL

1
Ø 5mm



crudo · raw · é cru

E4942-CR

1
Ø 5mm



blanco · white · blanc

E4942-W

1
Ø 5mm



CORDÓN ELÁSTICO · ELASTIC CORD · CORDON ÉLASTIQUE



40513

2,600 m Ø2mm



A40513

5 m Ø2mm



100%
POLY.



EXTENSOR DE PLÁSTICO
PLASTIC EXTENDER
RALLONGE EN PLASTIQUE

ALAMBRE PLASTIFICADO · PLASTICIZED WIRE · FIL PLASTIFIÉ



40532

1,200 m Ø3mm



A40532

3 m Ø3mm



40531

15x2 cm



AJUSTADOR PARA CORDÓN ELÁSTICO

ELASTIC CORD ADJUSTER · AJUSTEUR DE CORDON DE SERRAGE



HIGH
QUALITY

SILICONE

40530

1000u Ø1cm



A40530

10u Ø1cm







FILETRO PLANO

—
FLAT FELT

—
FEUTRE PLAT



Packaging
Z + Ref.

Bolsa
Bag
Sachet

	20 x 30 cm		20 x 30 cm 	30 x 45 cm	
	1	1	1	1	1
	1	1	1	1	1
	20u	10u	10u	20u	10u
	160gr/m ² 1mm aprox.	220gr/m ² 2mm aprox.	220gr/m ² 2mm aprox.	160gr/m ² .1mm aprox.	220gr/m ² 2mm aprox.
	Z55100	Z55200	Z55400	Z56100	Z56200
	Z55101	Z55201	Z55401	Z56101	Z56201
	Z55102	Z55202	Z55402	Z56102	Z56202
	Z55106	Z55206	Z55406	Z56106	Z56206
	Z55108	Z55208	Z55408	Z56108	Z56208
	Z55111	Z55211	Z55411	Z56111	Z56211
	Z55112	Z55212	Z55412	Z56112	Z56212
	Z55114	Z55214	Z55414	Z56114	Z56214
	Z55116	Z55216	Z55416	Z56116	Z56216
	Z55117	Z55217	Z55417	Z56117	Z56217
	Z55119	Z55219	Z55419	Z56119	Z56219
	Z55121	Z55221	Z55421	Z56121	Z56221
	Z55124	Z55224	Z55424	Z56124	Z56224
	Z55128	Z55228	Z55428	Z56128	Z56228
	Z55129	Z55229	Z55429	Z56129	Z56229
	Z55134	Z55234	Z55434	Z56134	Z56234
	Z55136	Z55236	Z55436	Z56136	Z56236
	Z55137	Z55237	Z55437	Z56137	Z56237
	Z55139	Z55239	Z55439	Z56139	Z56239
	Z55143	Z55243	Z55443	Z56143	Z56243
	Z55145	Z55245	Z55445	Z56145	Z56245
	Z55151	Z55251	Z55451	Z56151	Z56251



Combinación 22 colores · 22 colors combination · Combinaison 22 couleurs



22 1



	20x30cm	30x45cm
160gr/m ² (aprox.1mm)	55199	56199
220gr/m ² (aprox.2mm)	55299	56299

Bolsas de 22 colores (1 lámina de cada color).

22 1



	20x30cm
220gr/m ² (aprox.2mm)	55499

Bolsas de 22 colores (1 lámina de cada color).

Combinación blanco y negro

Black and white combination · Combinaison blanc et noir

4 1



	20x30cm	20x30cm	30x45cm
160gr/m ² (aprox.1mm)	55160		56160
220gr/m ² (aprox.2mm)	55260	55460	56260

Ref: ...00 - Ref: ...02

Combinación otoño

Autumn combination · Combinaison automne

1 4



	20x30cm	20x30cm	30x45cm
160gr/m ² (aprox.1mm)	55163		56163
220gr/m ² (aprox.2mm)	55263	55463	56263

Ref: ...28 - Ref: ...29 - Ref: ...34 - Ref: ...36

Combinación cálidos

Warm combination · Combinaison chauds

4 1



	20x30cm	20x30cm	30x45cm
160gr/m ² (aprox.1mm)	55161		56161
220gr/m ² (aprox.2mm)	55261	55461	56261

Ref: ...14 - Ref: ...16 - Ref: ...17 - Ref: ...19

Combinación primavera

Spring combination · Combinaison printemps

1 4

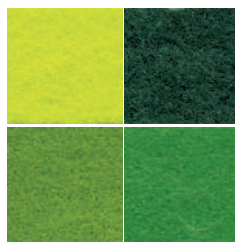

	20x30cm	20x30cm	30x45cm
160gr/m ² (aprox.1mm)	55164		56164
220gr/m ² (aprox.2mm)	55264	55464	56264

Ref: ...37 - Ref: ...39 - Ref: ...43 - Ref: ...45

Combinación fríos

Cold combination · Combinaison froid

1 4



	20x30cm	20x30cm	30x45cm
160gr/m ² (aprox.1mm)	55162		56162
220gr/m ² (aprox.2mm)	55262	55462	56262

Ref: ...14 - Ref: ...16 - Ref: ...17 - Ref: ...19

Combinación básicos

Basic combination · Combinaison basics

1 4

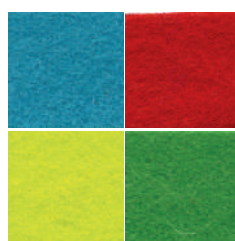

	20x30cm	20x30cm	30x45cm
160gr/m ² (aprox.1mm)	55165		56165
220gr/m ² (aprox.2mm)	55265	55465	56265

Ref: ...08 - Ref: ...17 - Ref: ...37 - Ref: ...45



FIELTRO PLANO · FLAT FELT · FEUTRE PLAT

Rollos fieltro acrílico plano
Acrylic felt flat rolls
Rouleau feutre plat acrylique



1x2mts

1

1

160gr/m2
1mm aprox.

57100

57102

57106

57108

57112

57116

57117

57124

57129

57134

57136

57143

57145

57151

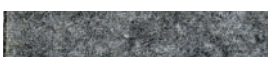





LÁMINAS EVA FOAM

—
EVA FOAM SHEETS

—
MOUSSE EVA PLAQUES



Packaging
Z + Ref.

Bolsa
Bag
Sachet

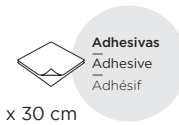

	20 x 30 cm		20 x 30 cm	40 x 60 cm	
	1	1	1	1	1
	1	1	1	1	1
	20u	20u	20u	20u	20u
	1mm	2mm	2mm	1mm	2mm
	Z21700	Z21800	Z21900	Z22500	Z22600
	Z21702	Z21802	Z21902	Z22502	Z22602
	Z21703	Z21803	Z21903	Z22503	Z22603
	Z21706	Z21806	Z21906	Z22506	Z22606
	Z21708	Z21808	Z21908	Z22508	Z22608
	Z21711	Z21811	Z21911	Z22511	Z22611
	Z21712	Z21812	Z21912	Z22512	Z22612
	Z21713	Z21813	Z21913	Z22513	Z22613
	Z21716	Z21816	Z21916	Z22516	Z22616
	Z21717	Z21817	Z21917	Z22517	Z22617
	Z21718	Z21818	Z21918	Z22518	Z22618
	Z21724	Z21824	Z21924	Z22524	Z22624
	Z21727	Z21827	Z21927	Z22527	Z22627
	Z21729	Z21829	Z21929	Z22529	Z22629
	Z21732	Z21832	Z21932	Z22532	Z22632
	Z21734	Z21834	Z21934	Z22534	Z22634
	Z21736	Z21836	Z21936	Z22536	Z22636
	Z21743	Z21843	Z21943	Z22543	Z22643
	Z21745	Z21845	Z21945	Z22545	Z22645
	Z21746	Z21846	Z21946	Z22546	Z22646



COMBINACIÓN 20 COLORES · 20 COLORS COMBINATION · COMBINAISON 20 COULEURS

🏠 20 🛒 1

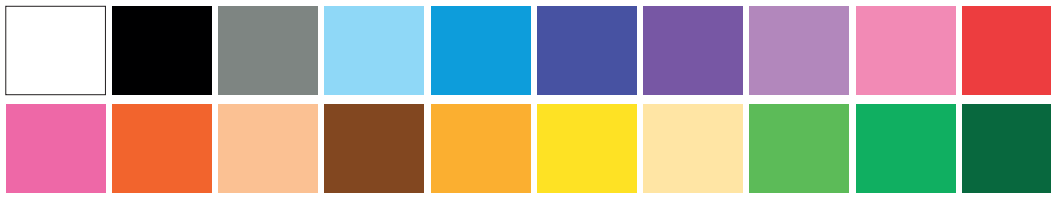

	20x30cm	20x30cm
1mm	21799	
2mm	21899	21999

COMBINACIÓN BLANCO Y NEGRO · BLACK AND WHITE COMBINATION · COMBINAISON BLANC ET NOIR

🏠 4 🛒 1

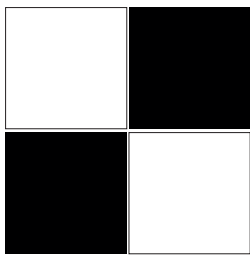

	20x30cm	20x30cm
1mm	21790	
2mm	21890	21990

Ref: ...00 - Ref: ...02

COMBINACIÓN OTOÑO · AUTUMN COMBINATION · COMBINAISON AUTOMNE

🏠 4 🛒 1

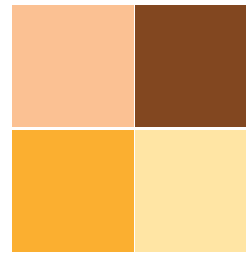

	20x30cm	20x30cm
1mm	21793	
2mm	21893	21993

Ref: ...27 - Ref: ...29 - Ref: ...32 - Ref: ...36

COMBINACIÓN CÁLIDOS · WARM COMBINATION · COMBINAISON CHAUDS

🏠 4 🛒 1

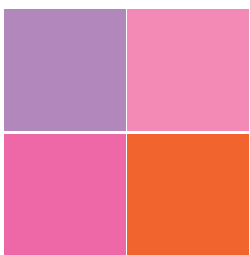

	20x30cm	20x30cm
1mm	21791	
2mm	21891	21991

Ref: ...13 - Ref: ...16 - Ref: ...18 - Ref: ...24

COMBINACIÓN PRIMAVERA · SPRING COMBINATION · COMBINAISON PRINTEMPS

🏠 4 🛒 1

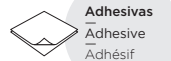
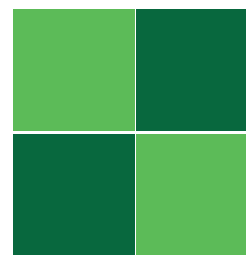

	20x30cm	20x30cm
1mm	21794	
2mm	21894	21994

Ref: ...43 - Ref: ...46

COMBINACIÓN FRIOS · COLD COMBINATION · COMBINAISON FROID

🏠 4 🛒 1

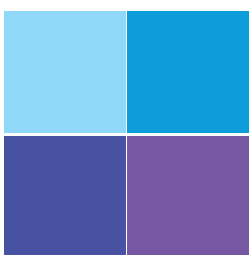

	20x30cm	20x30cm
1mm	21792	
2mm	21892	21992

Ref: ...06 - Ref: ...08 - Ref: ...11 - Ref: ...12

COMBINACIÓN BÁSICOS · BASIC COMBINATION · COMBINAISON BASICS

🏠 4 🛒 1

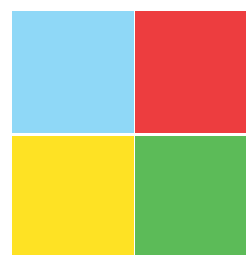

	20x30cm	20x30cm
1mm	21795	
2mm	21895	21995

Ref: ...06 - Ref: ...17 - Ref: ...34 - Ref: ...43

ROLLOS EVA FOAM · ROLLS EVA FOAM · ROULEAUX MOUSSE EVA

1 x 2mts

🛒 1

🕒 1

➦ 2mm



22700	22717
22702	22734
22708	22745

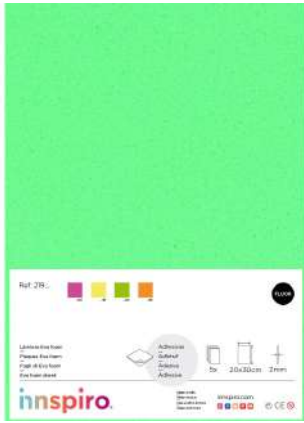

Adhesivas
Adhesive
Adhésif

	20 x 30 cm	40 x 60 cm
	1	1
	1	1
	5u	5u
	2mm	2mm
	21960	22660
	21961	22661
	21962	22662
	21963	22663

Colores sujetos a pequeñas variaciones por temas de impresión
 Colours subject to slight variations due to printing themes
 Les couleurs sont sujettes à des légères variations selon les thèmes d'impression





LÁMINAS EVA FOAM PURPURINA · EVA FOAM SHEETS GLITTER · MOUSSE EVA PAILLETTES



	20 x 30 cm	40 x 60 cm
	1	1
	1	1
	5u	5u
	2mm	2mm

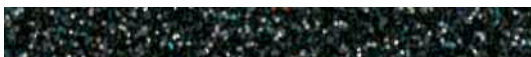

21965

22665



21966

22666



21967

22667



21968

22668



21969

22669



21970

22670



FORMAS PRECORTADAS DE GOMA EVA

EVA FOAM BASIC FORMS

FORMES BASIQUES MOUSSE EVA



Packaging Ref.

± 2mm aprox.

FORMAS BÁSICAS GOMA EVA · EVA FOAM BASIC FORMS · FORMES BASIQUES MOUSSE EVA

6

Básico adhesivo · Basic adhesive · Basique adhésif

Básico · Basic · Basique

Purpurina adhesivo · Glitter adhesive · Paillettes adhésives



32mm | 42mm

5 forms | 6 colors

98000

60u.



32mm | 42mm

5 forms | 6 colors

98300

100u.



32mm | 42mm

5 forms | 3 colors

98600

30u.



32mm | 42mm

6 colors

98001

60u.

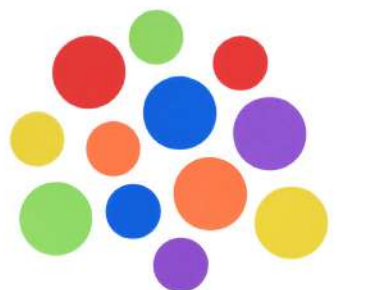

32mm | 42mm

6 colors

98301

100u.



32mm | 42mm

3 colors

98601

30u.



32mmx32mm
42mmx42mm

6 colors

98002

60u.

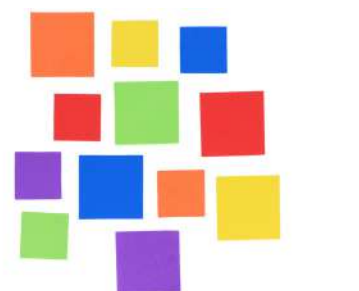

32mmx32mm
42mmx42mm

6 colors

98302

100u.



32mmx32mm
42mmx42mm

3 colors

98602

30u.



FORMAS BÁSICAS GOMA EVA · EVA FOAM BASIC FORMS · FORMES BASIQUES MOUSSE EVA

6

Básico adhesivo · Basic adhesive · Basique adhésif

Básico · Basic · Basique

Purpurina adhesivo · Glitter adhesive · Paillettes adhésives

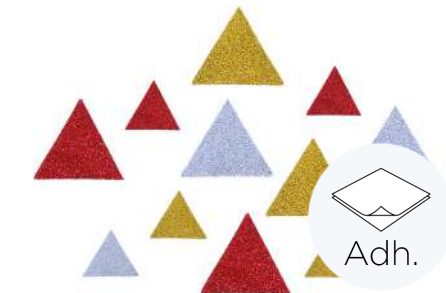
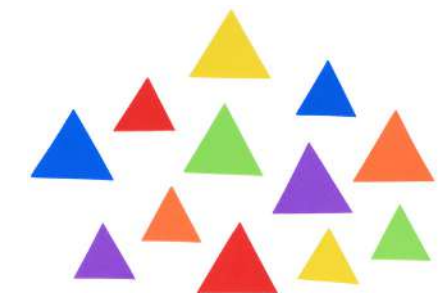

32mm | 42mm 6 colors
98003
60u.

32mm | 42mm 6 colors
98303
100u.

32mm | 42mm 3 colors
98603
30u.

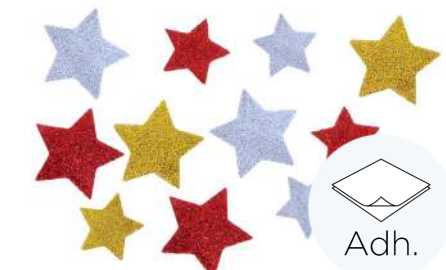

32mm | 42mm 6 colors
98004
60u.

32mm | 42mm 6 colors
98304
100u.

32mm | 42mm 3 colors
98604
30u.



32mm | 42mm 6 colors
98005
60u.

32mm | 42mm 6 colors
98305
100u.

32mm | 42mm 3 colors
98605
30u.



17mm | 22mm | 35mm | 47mm 6 colors
98012
64u.

17mm | 22mm | 35mm | 47mm 6 colors
98312
128u.

17mm | 22mm | 35mm | 47mm 3 colors
98612
32u.

6

Básico adhesivo · Basic adhesive · Basi-
que adhésif

Básico · Basic · Basique

Purpurina adhesivo · Glitter adhesive ·
Paillettes adhésives



25mm | 35mm | 47mm

6 colors

98013

60u.

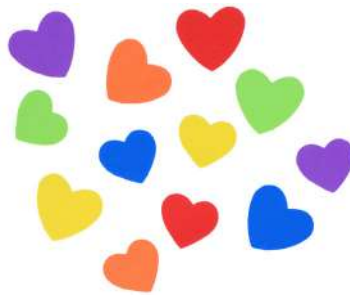

25mm | 35mm | 47mm

6 colors

98313

120u.



25mm | 35mm | 47mm

3 colors

98613

60u.



114x10mm

6 colors

98018

100u.

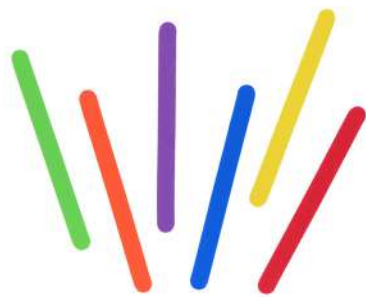

114x10mm

6 colors

98318

150u.



114x10mm

3 colors

98618

50u.

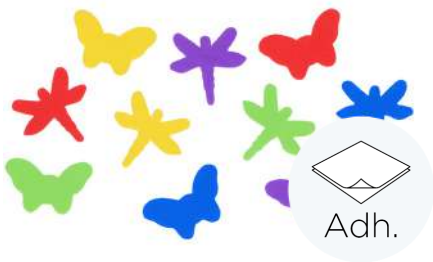

40mm | 42 mm

6 colors

98010

50u.



40mm | 42 mm

6 colors

98310

100u.

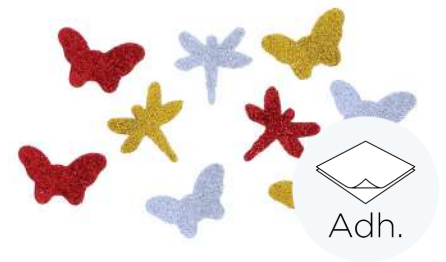

40mm | 42 mm

3 colors

98610

30u.



40mm

5 forms | 4 colors

98015

100u.



40mm

5 forms | 4 colors

98315

200u.



40mm

5 forms | 5 colors

98615

50u.



FORMAS BÁSICAS GOMA EVA · EVA FOAM BASIC FORMS · FORMES BASIQUES MOUSSE EVA

6

Flores
Flowers
Fleurs



20mm - 45mm

E7432

830u. aprox.

Different sizes and colors

Animales
Animals
Animaux



30mm - 90mm

E7434

1.070u. aprox.

Different sizes and colors





FORMAS BÁSICAS GOMA EVA · EVA FOAM BASIC FORMS · FORMES BASIQUES MOUSSE EVA

6

Básico adhesivo · Basic adhesive · Basique adhésif

Básico · Basic · Basique

Purpurina adhesivo · Glitter adhesive · Paillettes adhésives



35mm | 55mm

6 colors

98011

60u.



35mm | 55mm

6 colors

98311

100u.



35mm | 55mm

3 colors

98611

30u.



24mm | 32mm

6 colors

98014

120u.

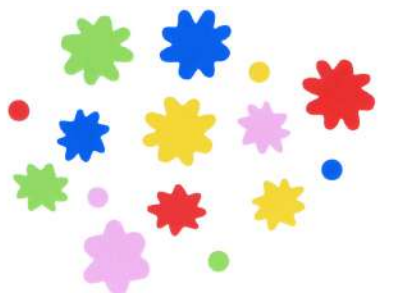

24mm | 32mm

6 colors

98314

200u.



24mm | 32mm

3 colors

98614

60u.



36mm | 45mm

6 colors

98017

40u.



36mm | 45mm

6 colors

98317

60u.



36mm | 45mm

3 colors

98617

30u.



30mm | 35mm | 45mm

6 colors

98016

40u.



30mm | 35mm | 45mm

6 colors

98316

120u.



30mm | 35mm | 45mm

3 colors

98616

30u.



FORMAS BÁSICAS GOMA EVA · EVA FOAM BASIC FORMS · FORMES BASIQUES MOUSSE EVA

6

Básico adhesivo · Basic adhesive · Basique adhésif

Básico · Basic · Basique

Purpurina adhesivo · Glitter adhesive · Paillettes adhésives



35mm | 47mm 6 colors

98031

30u.



35mm | 47mm 6 colors

98331

60u.



35mm | 47mm 3 colors

98631

30u.



35mm | 52mm 6 colors

98030

60u.



35mm | 52mm 6 colors

98330

120u.



22mm | 30mm 1 color

98032

60u.



37mm 7 colors

98033

55u.



Básico adhesivo · Basic adhesive · Basique adhésif

Básico · Basic · Basique

Purpurina adhesivo · Glitter adhesive · Paillettes adhésives

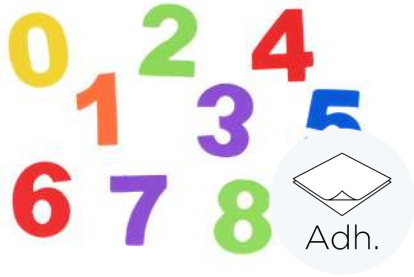

50mm 6 colors
98042
 60u.

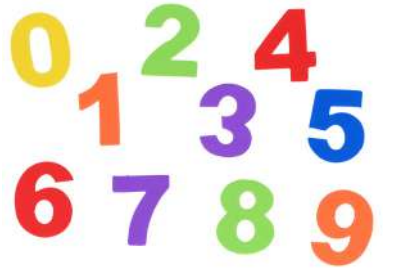

50mm 6 colors
98342
 120u.

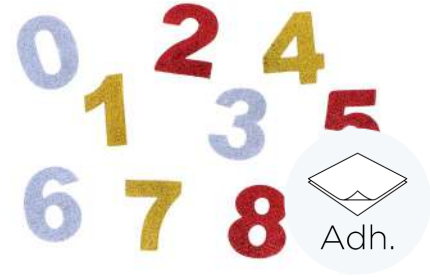

50mm 3 colors
98642
 30u.



50mm 6 colors
98044
 52u.



50mm 6 colors
98344
 104u.



50mm 6 colors
98644
 52u.



20mm 5 colors
98041
 180u.



20mm 5 colors
98341
 360u.



20mm 3 colors
98641
 124u.



22mm 6 colors
98046
 120u.

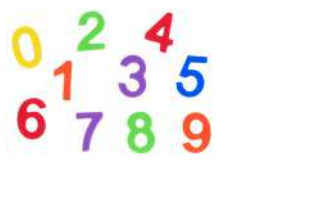

22mm 6 colors
98346
 240u.



22mm 3 colors
98646
 60u.



6

Básico adhesivo · Basic adhesive · Basique adhésif

Básico · Basic · Basique

Purpurina adhesivo · Glitter adhesive · Paillettes adhésives



50mm

6 colors

50mm

6 colors

50mm

3 colors

98048

52u.

98348

104u.

98648

52u.





PALOS DE POLO Y BASTONES

WOODEN STICKS

BÂTONNETS BOIS



Packaging Ref.

PALOS DE POLO DE MADERA · WOODEN POLO STICKS · BÂTONNETS EN BOIS



Mix colores · Mix colors · Mix couleurs

Natural · Natural · Naturel



75x15x1,5mm

6 colors

95550

100u.



75x15x1,5mm

95551

100u.



114x10x2mm

6 colors

99500

150u.



114x10x2mm

99501

150u.



150x18x1,5mm

6 colors

99540

80u.



150x18x1,5mm

99541

80u.

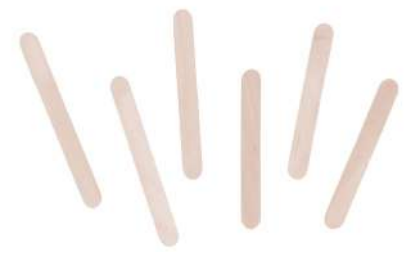

66x10x2mm

E7375

500u.



6



Mix colores · Mix colors · Mix couleurs

99570

150u.



Natural · Natural · Naturel

99571

150u.

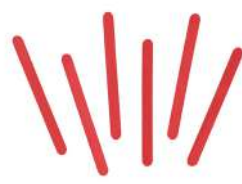

Rojo · Red · Rouge

99572

150u.



Naranja · Orange · Orange

99573

150u.



Verde · Green · Vert

99574

150u.



Amarillo · Yellow · Jaune

99575

150u.



Azul · Blue · Bleu

99576

150u.



Lila · Purple · Lila

99577

150u.





6

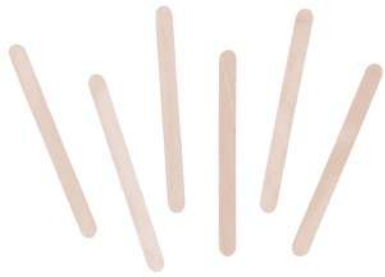

Natural · Natural · Naturel

103100

50u.



Amarillo · Yellow · Jaune

103101

50u.



Naranja · Orange · Orange

103102

50u.

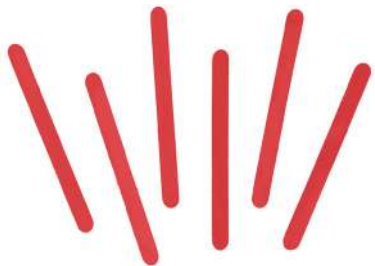

Rojo · Red · Rouge

103103

50u.



Azul · Blue · Bleu

103104

50u.



Verde · Green · Vert

103107

50u.



Rosa · Pink · Rose

103109

50u.



Lila · Purple · Lila

103110

50u.





PALOS DE POLO CON RANURAS · POLO STICKS WITH SLOT · BÂTONNETS AVEC RAINURES

6



114x10x2mm Mix colores · Mix colors · Mix couleurs

99520

100u.

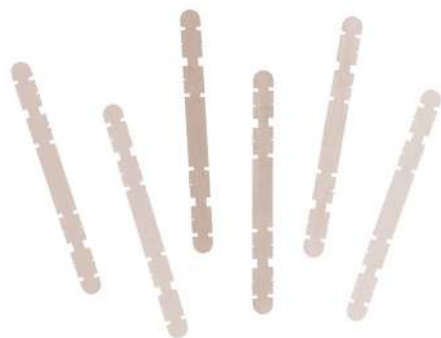

114x10x2mm

Natural · Natural · Naturel

99521

100u.



BASTONES DE MADERA · WOODEN STICKS · TIGES ALLUMETTES

Mix colores · Mix colors · Mix couleurs

Natural · Natural · Naturel



49x2x2mm

Cuadrados · Squares · Carrés

95560

500u.



49x2x2mm

Cuadrados · Squares · Carrés

95561

500u.



150x Ø5mm

Redondos · Round · Ronds

99530

60u.

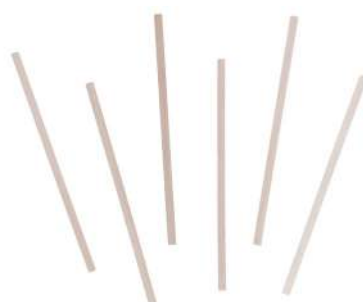

150x Ø5mm

Redondos · Round · Ronds

99531

60u.



150x Ø5mm

Redondos · Round · Ronds

E7329

40u.





PINZAS, BOTONES Y FORMAS DE MADERA

CLOTHESPIN, BUTTONS AND WOODEN FORMS

PINCES À LINGE, BOUTONS ET FORMES EN BOIS



Packaging
Ref.

PINZAS DE MADERA · WOODEN CLOTHESPIN · PINCES À LINGE EN BOIS

6



25x3mm Mix colors
99610
45u.



25x3mm Natural
99611
45u.



48x7mm Mix colors
99600
48u.



48x7mm Natural
99601
48u.



BOTONES DE MADERA · WOODEN BUTTONS · BOUTONS EN BOIS



12mm | 18mm | 22mm Mix colores · Mix colors · Mix couleurs
99740
30u.



12mm | 18mm | 22mm Natural · Natural · Naturel
99741
30u.

1



18mm | 20mm | 25mm
E7646
150u.

1



20mm | 24mm | 25mm
E7647
150u.

PUNTOS DE LIBRO · BOOKMARK · MARQUE-PAGE

🛒 1



12x7cm

E7428

🌲 40u.

🛒 3



30-90mm

E7436

🌲 12u.

FORMAS DE MADERA · WOODEN FORMS · FORMES EN BOIS

🛒 6



45mm (15u.) | 35mm (25u.) | 27mm (30u.)

Natural · Natural · Naturel

99585

🌲 70u.



45mm (15u.) | 35mm (25u.) | 27mm (30u.)

Natural · Natural · Naturel

99586

🌲 70u.

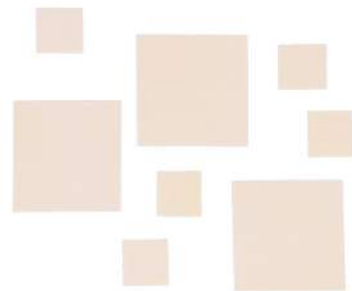

45mm (15u.) | 35mm (25u.) | 27mm (30u.)

Natural · Natural · Naturel

99587

🌲 70u.



45mm (15u.) | 35mm (25u.) | 27mm (30u.)

Natural · Natural · Naturel

99588

🌲 70u.

🛒 6



12x12x12mm

Mix colores · Mix colors · Mix couleurs

99580

🌲 72u.





LIMPIAPIPAS | CHENILLA

— PIPE CLEANERS

— CHENILLES

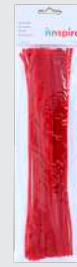

Packaging Ref.



6

LIMPIAPIPAS | CHENILLA · PIPE CLEANERS · CHENILLES

Ø4mm
x 30cm



Mix colores · Mix colors · Mix couleurs

99000

50u.

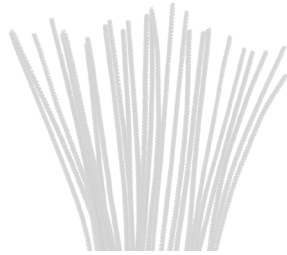

Blanco · White · Blanc

99001

50u.

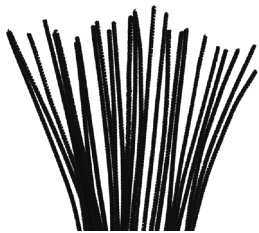

Negro · Black · Noir

99002

50u.



Azul · Blue · Bleu

99003

50u.



Verde · Green · Vert

99004

50u.



Rojo · Red · Rouge

99005

50u.



Amarillo · Yellow · Jaune

99006

50u.





LIMPIAPIPAS | CHENILLA · PIPE CLEANERS · CHENILLES

Ø6mm
x 30cm

6



Mix colores · Mix colors · Mix couleurs

99010

25u.

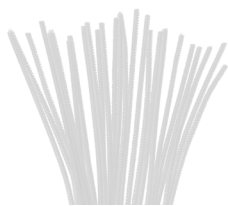

Blanco · White · Blanc

99011

25u.



Negro · Black · Noir

99012

25u.



Amarillo · Yellow · Jaune

99016

25u.



Naranja · Orange · Orange

99017

25u.



Verde · Green · Vert

99018

25u.

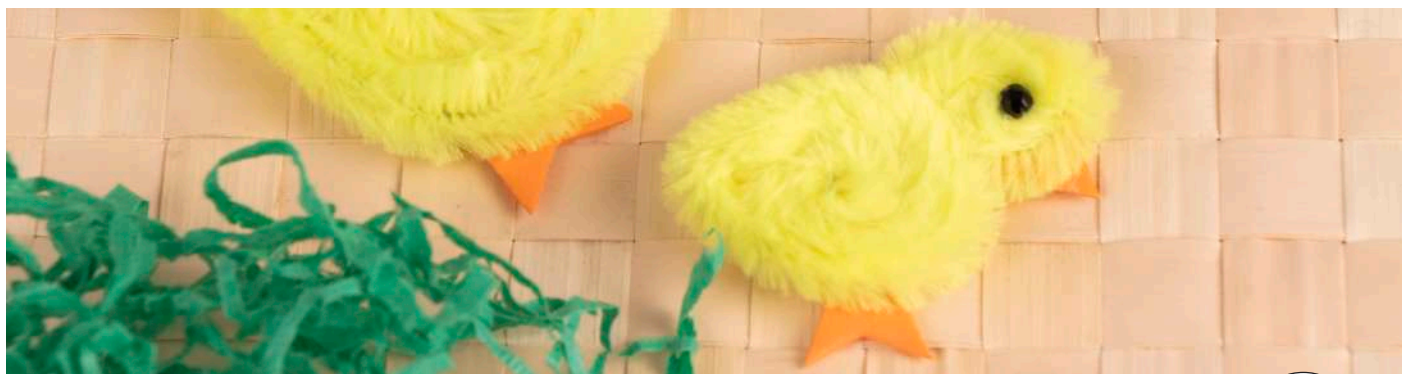

LIMPIAPIPAS | CHENILLA · PIPE CLEANERS · CHENILLES

Ø8mm
x 30cm

6

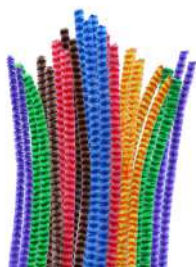

Mix colores · Mix colors · Mix couleurs

99050

25u.



Azul · Blue · Bleu

99053

25u.



Amarillo · Yellow · Jaune

99056

25u.



Naranja · Orange · Orange

99057

25u.



Lila · Purple · Lila

99058

25u.



Rosa · Pink · Rosa

99059

25u.



LIMPIAPIPAS | CHENILLA ACRÍLICO · ACRYLIC PIPE CLEANERS · CHENILLES ACRYLIQUE

Ø15mm x 50cm

6



Mix colores · Mix colors · Mix couleurs

99040

10u.



Azul · Blue · Bleu

99043

10u.



Verde · Green · Vert

99044

10u.



Amarillo · Yellow · Jaune

99046

10u.



Naranja · Orange · Orange

99047

10u.



Lila · Purple · Lila

99048

10u.



Fucsia · Fuchsia · Fuchsia

99049

10u.

LIMPIAPIPAS
CHENILLA TWINE · TWINE PIPE CLEANERS · CHENILLE TWINE

6

Ø8mm x 30cm



99020

15u.

MIX

6

maxi pack



E7231

150u.





LIMPIAPIPAS | CHENILLA FORMAS · FORMS PIPE CLEANERS · CHENILLE SPIRALE

Ø13mm
x 30cm

6



Mix colores · Mix colors · Mix couleurs

99060

25u.



Blanco · White · Blanc

99061

25u.



Negro · Black · Noir

99062

25u.



Azul · Blue · Bleu

99063

25u.



Verde oscuro · Dark green · Vert foncé

99064

25u.



Rojo · Red · Rouge

99065

25u.



Amarillo · Yellow · Jaune

99066

25u.



LIMPIAPIPAS | CHENILLA METÁLICOS · PIPE CLEANERS · CHENILLE METALLISÉE

Ø3mm
x 30cm

6



Mix colores · Mix colors · Mix couleurs

99070

40u.



Plata · Silver · Argent

99071

40u.



Azul · Blue · Bleu

99073

40u.



Verde · Green · Vert

99074

40u.



Rojo · Red · Rouge

99075

40u.



Oro · Gold · Or

99076

40u.



Lila · Purple · Lila

99078

40u.



LIMPIAPIPAS | CHENILLA METÁLICOS · PIPE CLEANERS · CHENILLE METALLISÉE

Ø 6mm
x 30cm

6



Mix colores · Mix colors · Mix couleurs

E7232

24u.



Mix colores · Mix colors · Mix couleurs

99080

25u.



Plata · Silver · Argent

99081

25u.



Azul · Blue · Bleu

99083

25u.



Verde · Green · Vert

99084

25u.



Rojo · Red · Rouge

99085

25u.



Oro · Gold · Or

99086

25u.



Lila · Purple · Lila

99088

25u.

LIMPIAPIPAS | CHENILLA METÁLICOS · PIPE CLEANERS · CHENILLE METALLISÉE

Ø 10mm
x 30cm

6



Mix colores · Mix colors · Mix couleurs

99090

10u.



Plata · Silver · Argent

99091

10u.



Azul · Blue · Bleu

99093

10u.



Verde · Green · Vert

99094

10u.



Rojo · Red · Rouge

99095

10u.



Oro · Gold · Or

99096

10u.



Lila · Purple · Lila

99098

10u.





POMPONES

—
POMPOMS

—
POMPONS



Packaging
Ref.

POMPONES ACRÍLICOS CON TUBO · ACRYLIC POMPOM WITH TUBE · POMPONS ACRYLIQUES AVEC TUBE À ENFILER

Ø25
mm

🛒 6

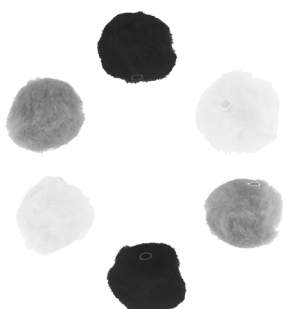

Blanco · Negro · Gris · White · Black · Grey · Blanc · Noir · Gris

99301

🔺 50u.

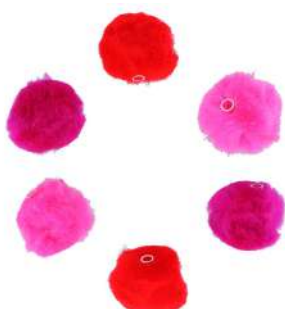

3 tonos rojo · 3 red tones · 3 tons rouge

99302

🔺 50u.

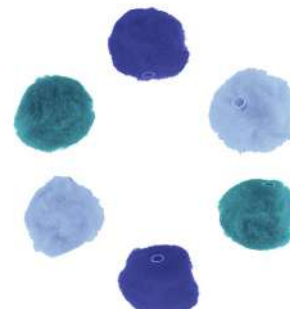

3 tonos azul · 3 blue tones · 3 tons bleu

99303

🔺 50u.

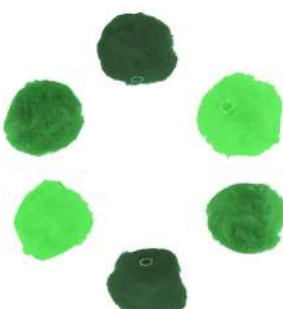

3 tonos verde · 3 green tones · 3 tons vert

99304

🔺 50u.

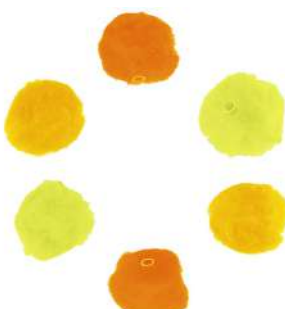

3 tonos amarillo · 3 yellow tones · 3 tons jaune

99305

🔺 50u.



3 tonos rosa · 3 pink tones · 3 tons rose

99309

🔺 50u.

POMPONES LANA · WOOL POMPOM · POMPONS LAINE

🛒 6

Ø30
mm



Mix colores · Mix colors · Mix couleurs

E7476

🔺 100u.





Ø25 mm

6



Mix colores · Mix colors · Mix couleurs

99410

50u.

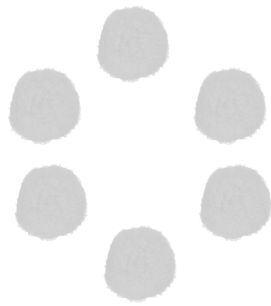

Blanco · White · Blanc

99411

50u.

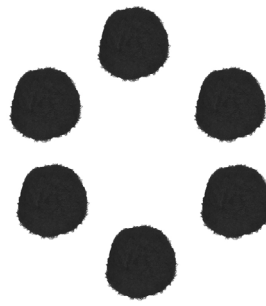

Negro · Black · Noir

99412

50u.

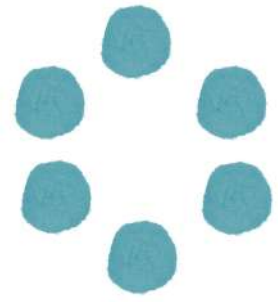

Azul · Blue · Bleu

99413

50u.

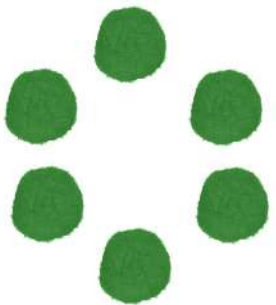

Verde · Green · Vert

99414

50u.

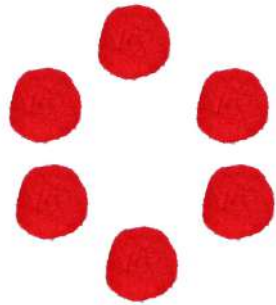

Rojo · Red · Rouge

99415

50u.

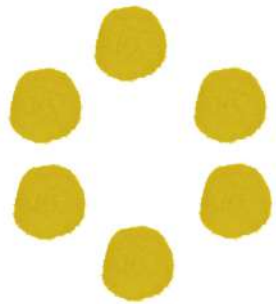

Amarillo · Yellow · Jaune

99416

50u.

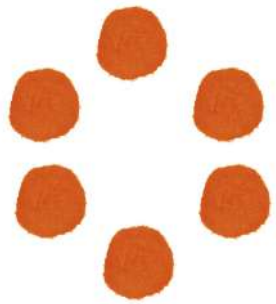

Naranja · Orange · Orange

99417

50u.

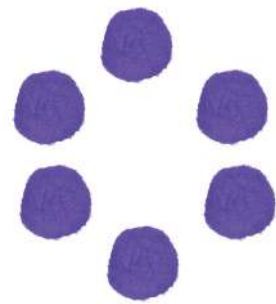

Lila · Purple · Lila

99418

50u.

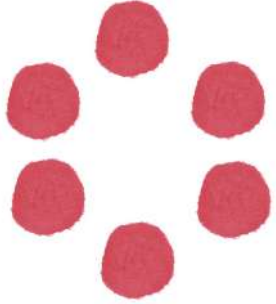

Rosa · Pink · Rose

99419

50u.





POMPONES BRILLANTES · BRILLIANT POMPOM · POMPONS MÉTALLISÉS

Ø25 mm

6



Mix colores · Mix colors · Mix couleurs

99460

20u.

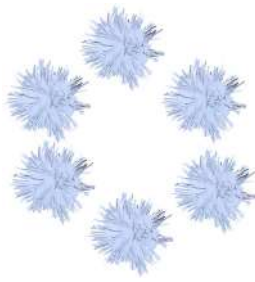

Blanco · White · Blanc

99461

20u.

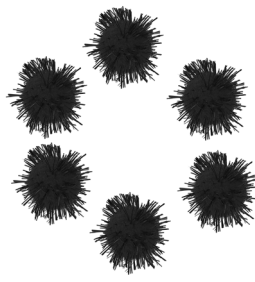

Negro · Black · Noir

99462

20u.

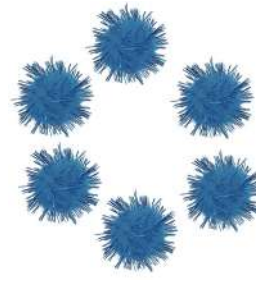

Azul · Blue · Bleu

99463

20u.

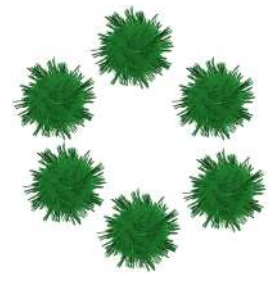

Verde · Green · Vert

99464

20u.

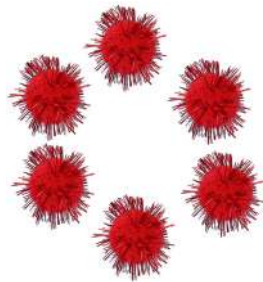

Rojo · Red · Rouge

99465

20u.

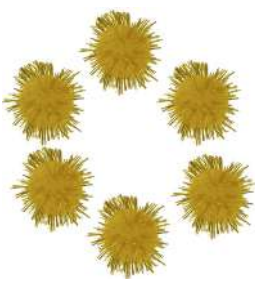

Amarillo · Yellow · Jaune

99466

20u.



Naranja · Orange · Orange

99467

20u.



Lila · Purple · Lila

99468

20u.



Rosa · Pink · Rose

99469

20u.

POMPONES MIX · MIX POMPOM · POMPONS MIX

6



Ø5mm

Mix colores · Mix colors · Mix couleurs

99430

500u.



Ø10mm

Mix colores · Mix colors · Mix couleurs

99420

200u.



Ømix

Mix colores · Mix colors · Mix couleurs

99440

78u.



Ømix

Mix colores · Mix colors · Mix couleurs

99450

78u.



Ømix

Mix colores · Mix colors · Mix couleurs

E7234

200u.



Ø50mm

Mix colores · Mix colors · Mix couleurs

99400

50u.



ALFILERES

— PINS

— ÉPINGLES



Packaging Ref.

CABEZA COLORES · COLOURED HEAD · TÊTE COLORIÉE

22x0,65mm 250u. 1 5

- | | | |
|-------|-------|-------|
| 36000 | 36001 | 36002 |
| 36003 | 36004 | 36005 |
| 36006 | 36007 | 36008 |
| 36009 | 36010 | 36011 |



PLATEADO · SILVER PLATED · ARGENTÉ

500u. 1 5

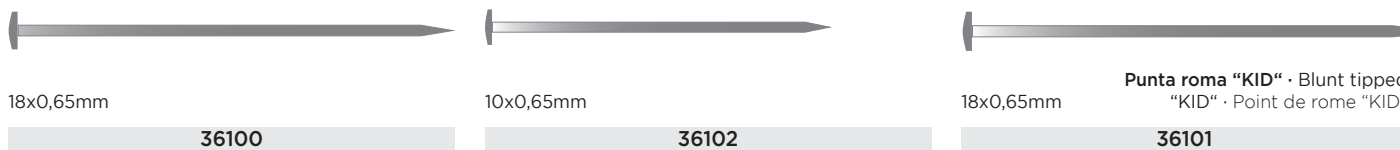

Punta roma "KID" · Blunt tipped "KID" · Point de roma "KID"

PUNTAS DE LATÓN · BRASS TIPS · POINTES LAITONS

5



14 x Ø1mm

E6488

5.000u. aprox.





LENTEJUELAS

—
SEQUINS

—
PAILLETES



Packaging
Ref.

Bolsa
Bag
Sachet

5gr. aprox.
Ø 7mm

🛒 6



Packaging
B + Ref.

Bote
Box
Boîte

35gr.
Ø 7mm

🛒 4



Packaging
Z + Ref.

Bolsa
Bag
Sachet

500gr.
Ø 7mm

🛒 1

LENTEJUELAS OPACAS · OPAQUE SEQUINS · PAILLETES OPAQUES



14707



14708



14722



14723



14724



14725



14726



14727



14728



14729

LENTEJUELAS TRANSPARENTES · TRANSPARENT SEQUINS · PAILLETES TRANSPARENTS



14711



14713



14714



14715



14716



14717



14718



14719



14720



14721

LENTEJUELAS AURORA BOREAL · PEARLISED SEQUINS · PAILLETES PERLÉ



14730



14731



14732



14733



14734



14735



14736

LENTEJUELAS PLATEADAS · SILVERED SEQUINS · PAILLETES ARGENTÉES



14700



14701



14702



14704



14705



14706



14709



14710



14712





ADORNOS

—
ORNEMENTS

—
ORNEMENTS



Packaging
Ref.

6

LENTEJUELAS PLATEADAS (formas y alfabetos) · SILVERED SEQUINS (forms and alphabets) · PAILLETES ARGENTÉES (formes et alphabets)



Animales
Animals
Animaux

Ømix

99700

28gr.



Mariposas y flores
Butterflies and flowers
Papillons et fleurs

Ømix

99701

28gr.



Números
Numbers
Numéros

6mm

99702

28gr.



Letras
Letters
Lettres

6mm

99703

28gr.



Mix
Mix
Mix

6mm

99704

28gr.



Copos de nieve
Snowflake
Flocons de neige

24mm

99705

14gr.



Pajaritas
Bow tie
Noeuds papillon

13mm

99706

14gr.



Flores
Flowers
Fleurs

20mm

99707

14gr.



Flores
Flowers
Fleurs

11mm

99708

14gr.



Margaritas
Daisies
Marguerites

15mm

99709

14gr.



Cuadrados
Squares
Carrés

5mm

99710

14gr.



Corazones
Hearts
Coeurs

18mm

99715

14gr.

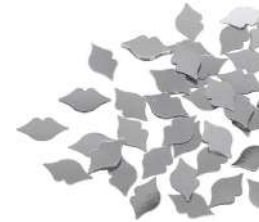

Labios
Lips
Lèvres

14mm

99716

14gr.



CAMPANILLAS · SMALL BELLS · CLOCHETTES



Oro · Gold · Or



8mm · 10mm · 12mm

99900

30u.



8mm

99901

40u.



10mm

99902

30u.



12mm

99903

20u.

Plata · Silver · Argent



8mm · 10mm · 12mm

99905

30u.



8mm

99906

40u.



10mm

99907

30u.



12mm

99908

20u.



CASCABELES · BELLS · GRELOTS

6



25u oro · gold · or
25u plata · silver · argent
12mm

SP-99913-50

50u.

Oro · Gold · Or



8mm · 10mm · 12mm

99910

30u.



8mm

99911

40u.



10mm

99912

30u.



12mm

99913

20u.

Plata · Silver · Argent



8mm · 10mm · 12mm

99915

30u.



8mm

99916

40u.



10mm

99917

30u.



12mm

99918

20u.

CASCABELES MIX · MIX BELLS · GRELOTS MIX

6



Mix colores · Mix colors · Mix couleurs

Ø19-6mm

E7241

250u.aprox.

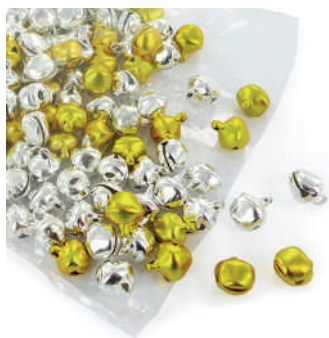

Mix oro y plata

Gold and silver mix · Mix or et argent

Ø 10mm

E7254-10

250u.aprox.





FORMAS DE CELULOSA
—
CELLULOSE FORMS
—
FORMES DE CELLULOSE



Packaging
Ref.

Bolsa
Bag
Sachet

1

BOLAS CELULOSA CON AGUJERO CIEGO · CELLULOSE BALLS WITH BLIND HOLE · BOULES DE CELLULOSE AVEC TROU BORGNE

	103200	103201	103202	103203	103204	103205	103206
∅	12mm	15mm	18mm	20mm	25mm	30mm	40mm
	100u.	100u.	100u.	100u.	100u.	100u.	50u.
	103207	103208	103209	103210			
∅	50mm	60mm	70mm	80mm			
	25u.	20u.	10u.	10u.			

HUEVOS CELULOSA CON AGUJERO CIEGO · CELLULOSE EGGS WITH BLIND HOLE · OEUFS DE CELLULOSE AVEC TROU BORGNE

	103220	103221	103222	103223	103224
∅	18mm	30mm	40mm	50mm	70mm
	100u.	100u.	50u.	10u.	10u.





PLUMAS
—
FEATHERS
—
PLUMES



Packaging
Ref.

PLUMAS INDIO · INDIAN FEATHERS · PLUMES INDIEN

6



25mm-140mm **Mix colores · Mix colors · Mix couleurs**

97330

60u.



25mm - 140mm **Blanco · White · Blanc**

97331

60u.



25mm - 140mm **Negro · Black · Noir**

97332

60u.



25mm - 140mm **Azul · Blue · Bleu**

97333

60u.



25mm - 140mm **Verde · Green · Vert**

97334

60u.



25mm - 140mm **Rojo · Red · Rouge**

97335

60u.



25mm - 140mm **Amarillo · Yellow · Jaune**

97336

60u.



25mm - 140mm **Naranja · Orange · Orange**

97337

60u.



25mm - 140mm **Lila · Purple · Lila**

97338

60u.





PLUMÓN SUAVE · SOFT FEATHER · PLUMULE DOUCE

6



75mm **Mix colores · Mix colors · Mix couleurs**
97320
14gr.



75mm **Blanco · White · Blanc**
97321
14gr.

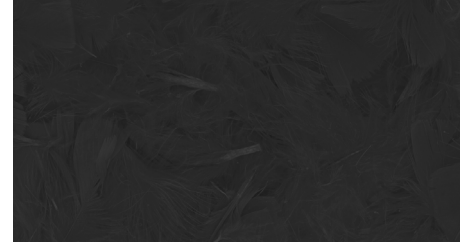

75mm **Negro · Black · Noir**
97322
14gr.



75mm **Azul · Blue · Bleu**
97323
14gr.



75mm **Verde · Green · Vert**
97324
14gr.



75mm **Rojo · Red · Rouge**
97325
14gr.



75mm **Amarillo · Yellow · Jaune**
97326
14gr.



75mm **Naranja · Orange · Orange**
97327
14gr.



75mm **Lila · Purple · Lila**
97328
14gr.





OJOS MÓVILES

— FEATHERS

— PLUMES



Packaging Ref.

OJOS MÓVILES REDONDOS · ROUND MOBILE EYES · YEUX MOBILES ROUNDS

6



Ø mix

97100

75u.

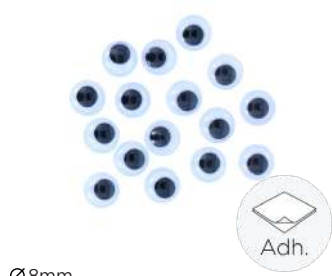

Ø8mm

97101

80u.



Ø10mm

97102

72u.



Ø12mm

97103

60u.

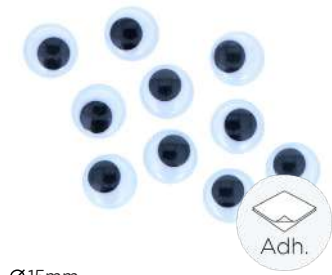

Ø15mm

97104

48u.



Ø20mm

97105

24u.

OJOS MÓVILES OVALADOS · OVAL MOBILE EYES · YEUX MOBILES OVALES

6



mix

97110

64u.

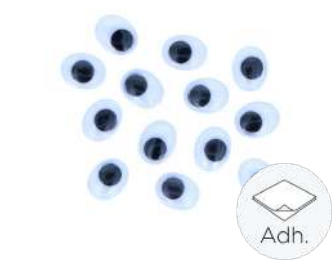

8x10mm

97111

80u.



10x13mm

97112

70u.



11x14mm

97113

60u.



12x16mm

97114

50u.





OJOS MÓVILES MIX · MOBILE EYES MIX · YEUX MOBILES MIX

6



Adh.

Ømix

Mix colores · Mix colors · Mix couleurs

97130

▲ 64u.



Adh.

Ømix

Mix colores · Mix colors · Mix couleurs

97140

▲ 75u.



Adh.

Ømix

Negro · Black · Noir

97160

▲ 42u.



Adh.

Ømix

Mix colores · Mix colors · Mix couleurs

97161

▲ 52u.

OJOS MÓVILES FOSFORESCENTE · FLUORESCENT MOBILE EYES · YEUX MOBILES FLUORESCENTS

6



Adh.

Ø8mm

Negro · Black · Noir

97151

▲ 40u.



Adh.

Ø15mm

Negro · Black · Noir

97152

▲ 16u.



Adh.

Ø18mm

Negro · Black · Noir

97153

▲ 12u.



Adh.

8mm · 15mm · 18mm

Negro · Black · Noir

SP-97150

▲ 100u. aprox.

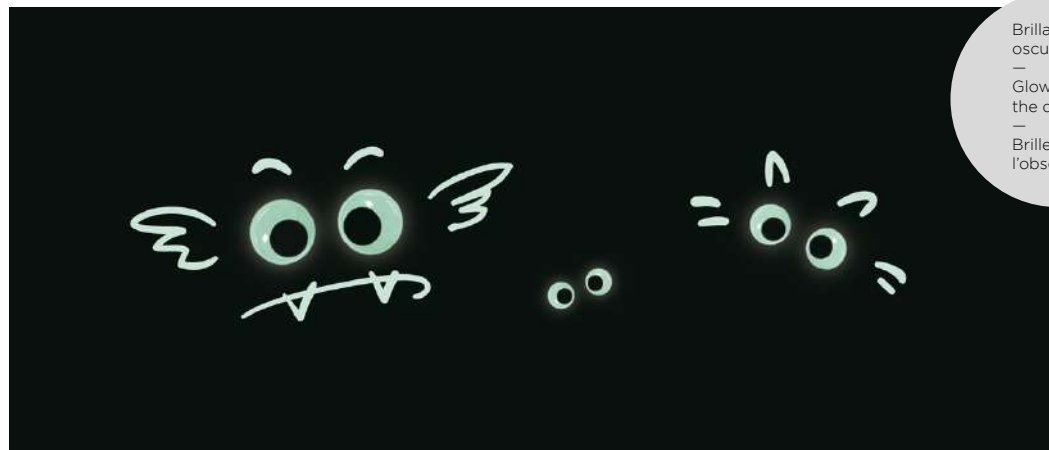

Brilla en la oscuridad
—
Glow in the dark
—
Brille dans l'obscurité

OJOS MÓVILES REDONDOS PARA COSER · SEWING MOBILE ROUND EYES · YEUX MOBILES ROUNDS POUR COUDRE

6



Adh.

Ømix

97120

▲ 52u.



Negro · Black · Noir

OJOS MÓVILES · MOBILE EYES · YEUX MOBILES

6



Adh.

Mix colores · Mix colors · Mix couleurs

7mm · 10mm · 12mm · 15mm

E7238-10MM

▲ 100u. aprox.



Adh.

Negro · Black · Noir

7mm · 10mm · 12mm · 15mm

E7237

▲ 100u. aprox.



RAFIA DE PAPEL

—
RAFFIA PAPER

—
RAPHIA DE PAPIER



Packaging Ref.

6



4mmx30m **Blanco** · White · Blanc
99811



4mmx30m **Negro** · Black · Noir
99812



4mmx30m **Azul** · Blue · Bleu
99813



4mmx30m **Verde** · Green · Vert
99814



4mmx30m **Rojo** · Red · Rouge
99815



4mmx30m **Amarillo** · Yellow · Jaune
99816



4mmx30m **Marrón** · Brown · Marron
99817

set

6



4mmx30m **Pack 6 colores** · Pack 6 colors · Pack 6 couleurs
SP-99810





ALAMBRE RECUBIERTO DE PAPEL

— PAPERLESS WIRE

— FIL DE FER RECOUVERT DE PAPIER



Packaging Ref.

6



Ø3mmx10m **Blanco** · White · Blanc
99801



Ø3mmx10m **Negro** · Black · Noir
99802



Ø3mmx10m **Azul** · Blue · Bleu
99803



Ø3mmx10m **Verde** · Green · Vert
99804



Ø3mmx10m **Rojo** · Red · Rouge
99805



Ø3mmx10m **Amarillo** · Yellow · Jaune
99806



Ø3mmx10m **Marrón** · Brown · Marron
99807

set

6



Ø3mmx10m **Pack 6 colores** · Pack 6 colors · Pack 6 couleurs
SP-99800



PLANTILLAS

—
STENCILS

—
POCHOIRS



5x30cm 🗑️ 3

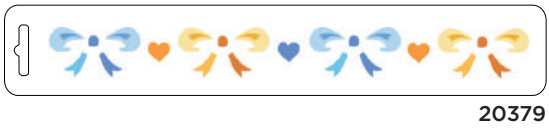

9x21cm 🗑️ 3

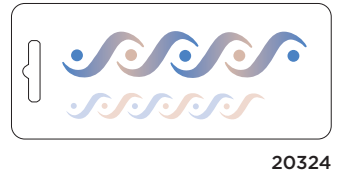
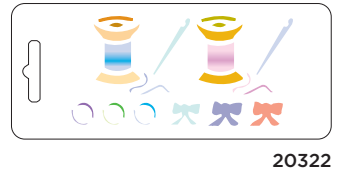
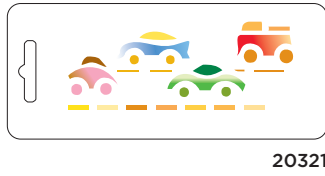
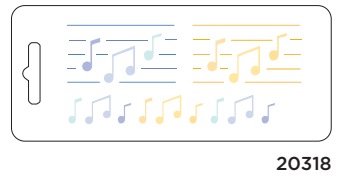

10x30cm 🗑️ 3

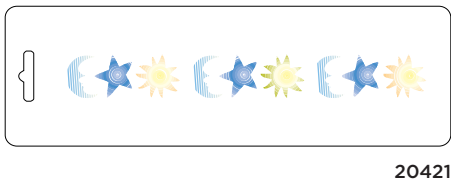
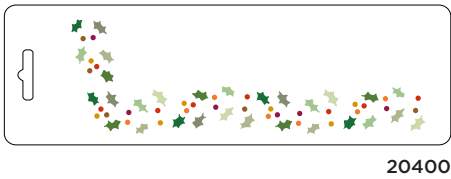
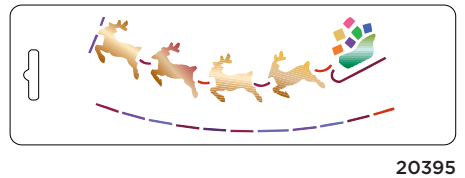
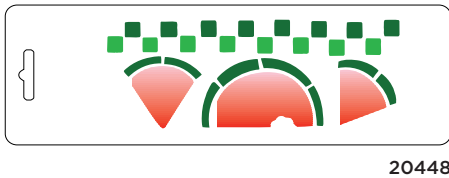



15x21cm 3



20306



20327



20338



20340



20341

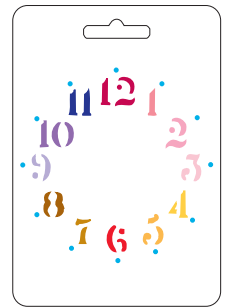

20307



20329



20328



20425

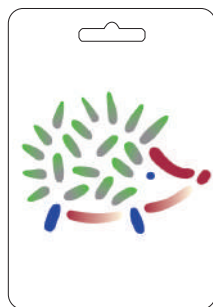

20427

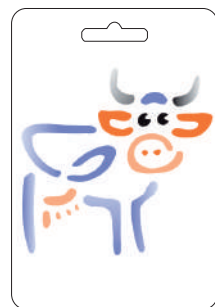

20428



20430

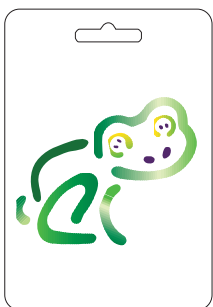

20438



20449

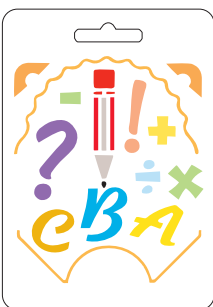

20451



GEMMAS ACRÍLICAS DECORATIVAS

DECORATIVE ACRYLIC GEMS

GEMMES ACRYLIQUES DÉCORATIVES



Packaging
Z + Ref.

Bolsa
Bag
Sachet

🛒 1

Gemas acrílicas de alta calidad, con gran transparencia y un magnífico brillo similar al diamante. Con la cola GLUE GEMS puedes pegar las gemas acrílicas en cualquier tipo de superficie.

High quality acrylic gems, with great transparency and an excellent sheen similar to a diamond. With the GLUE GEMS glue you can paste acrylic gems on any type of surface.

Gemmes acryliques décoratives de grande qualité, avec grande transparence et magnifique luminosité semblable à celle du diamant. Avec la colle GLUE GEMS vous pouvez coller les gemmes acryliques sur toutes surfaces.

CÍRCULOS ACRÍLICOS · ACRYLIC CIRCLES · CERCLES ACRYLIQUES

	1	1	1	1
🛒	5000u.	2000u.	200u.	100u.
📏	Ø6mm	Ø10mm	Ø18mm	Ø25mm
	Z2000601	Z2001001	Z2001801	Z2002501
	Z2000602	Z2001002	Z2001802	Z2002502
	Z2000603	Z2001003	Z2001803	Z2002503
	Z2000604	Z2001004	Z2001804	Z2002504
	Z2000605	Z2001005	Z2001805	Z2002505
	Z2000606	Z2001006	Z2001806	Z2002506
	Z2000607	Z2001007	Z2001807	Z2002507
	Z2000608	Z2001008	Z2001808	Z2002508
	Z2000609	Z2001009	Z2001809	Z2002509

• Colores flúor · Fluor colors · Couleurs fluor

BOTE CÍRCULOS ACRÍLICOS · ACRYLIC CIRCLES BOX BOCAL CERCLES ACRYLIQUES

Bote compuesto por círculos acrílicos de cuatro medidas y nueve colores distintos. Con más de 1.100 piezas para decorar un sinfín de proyectos.

Acrylic circles box composed of four sizes and nine different colors. With more than 1,100 pieces to decorate countless projects.

Bocal composé par des cercles acryliques en quatre mesures et neuf couleurs différentes. Avec plus de 1.100 pièces pour décorer une infinité de projets.

2005010
Ø6mm | Ø10mm
Ø18mm | Ø25mm

🛒 1188u. aprox
🛒 1



MIX 9 COLORS

2000610

Ø6mm
multi color
900x
aprox.

🛒 1



MIX 9 COLORS

2001010

Ø10mm
multi color
225x
aprox.

🛒 1





SET COLORES BÁSICOS CÍRCULOS ACRÍLICOS · ACRYLIC CIRCLES BASIC COLORS SET · SET COULEURS BASE CERCLES ACRYLIQUES

🗑️ 1



	2000611	2001011	2001811	2002511
	Ø6mm	Ø10mm	Ø18mm	Ø25mm
	(100u. x color) 600u. aprox	(40u. x color) 240u. aprox	(20u. x color) 100u. aprox	(8u. x color) 40u. aprox

SET COLORES FLÚOR CÍRCULOS ACRÍLICOS · ACRYLIC CIRCLES FLUOR COLORS SET · SET COULEURS FLUOR CERCLES ACRYLIQUES

🗑️ 1



	2000612	2001012	2001812	2002512
	Ø6mm	Ø10mm	Ø18mm	Ø25mm
	(100u. x color) 600u. aprox	(40u. x color) 240u. aprox	(20u. x color) 100u. aprox	(8u. x color) 40u. aprox

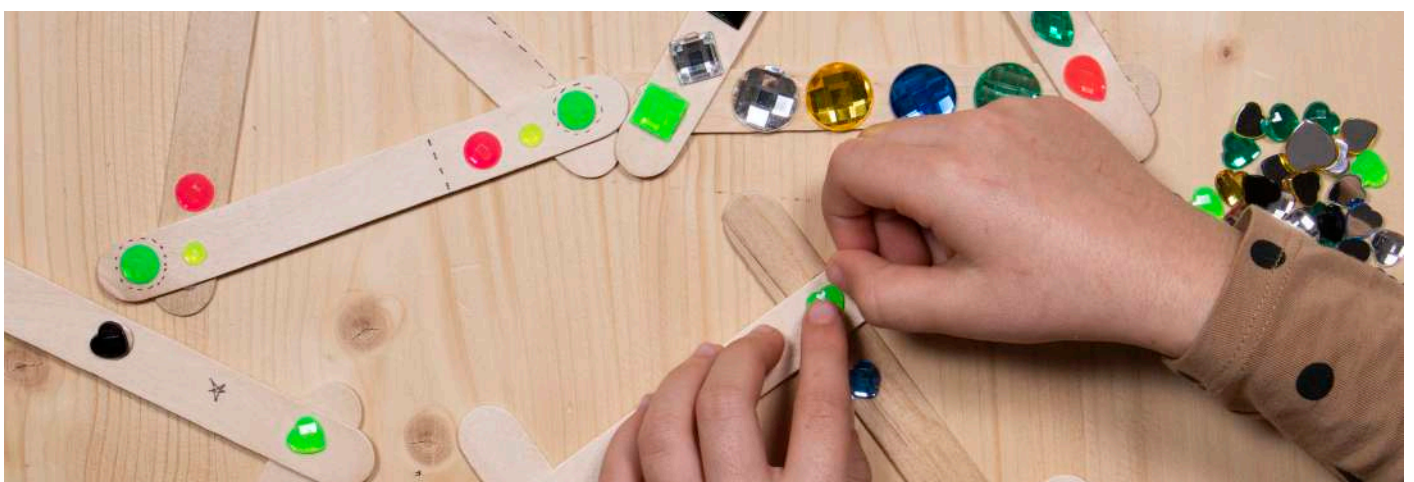



	1	1	1
	2000u.	500u.	00u.
	8x8mm	12x12mm	16x16mm

	Z2150801	Z2151201	Z2151601
	Z2150802	Z2151202	Z2151602
	Z2150803	Z2151203	Z2151603
	Z2150804	Z2151204	Z2151604
	Z2150805	Z2151205	Z2151605
	Z2150806	Z2151206	Z2151606
	Z2150807	Z2151207	Z2151607
	Z2150808	Z2151208	Z2151608
	Z2150809	Z2151209	Z2151609

• Colores flúor · Fluor color · Couleurs fluor

maxi pack

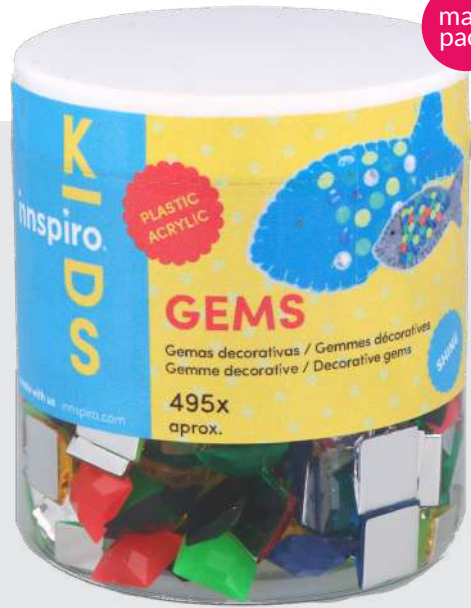

2005012

8x8mm | 12x12mm | 16x16mm

495u. aprox
 1

BOTE CUADRADOS ACRÍLICOS · ACRYLIC SQUARES BOX
BOCAL CARRÉS ACRYLIQUES

Bote compuesto por cuadrados acrílicos de tres medidas y nueve colores distintos. Con más de 400 piezas para decorar un sinfín de proyectos.

Acrylic squares box composed of three sizes and nine different colors. With more than 400 pieces to decorate countless projects.

Bocal composé par des carrés acryliques en trois mesures et neuf couleurs différentes. Avec plus de 400 pièces pour décorer une infinité de projets.





SET COLORES BÁSICOS CUADRADOS ACRÍLICOS · ACRYLIC SQUARES BASIC COLORS SET · SET COULEURS BASE CARRÉ ACRYLIQUE

🛒 1



2150811	2151211	2151611
8x8mm	12x12mm	16x16mm
(40u. x color) 240u. aprox	(25u. x color) 125u. aprox	(20u. x color) 100u. aprox

SET COLORES FLÚOR CUADRADOS ACRÍLICOS · ACRYLIC SQUARES FLOUR COLORS SET · SET COULEURS FLUOR CARRÉ ACRYLIQUE

🛒 1



2150812	2151212	2151612
8x8mm	12x12mm	16x16mm
(40u. x color) 240u. aprox	(25u. x color) 125u. aprox	(20u. x color) 100u. aprox

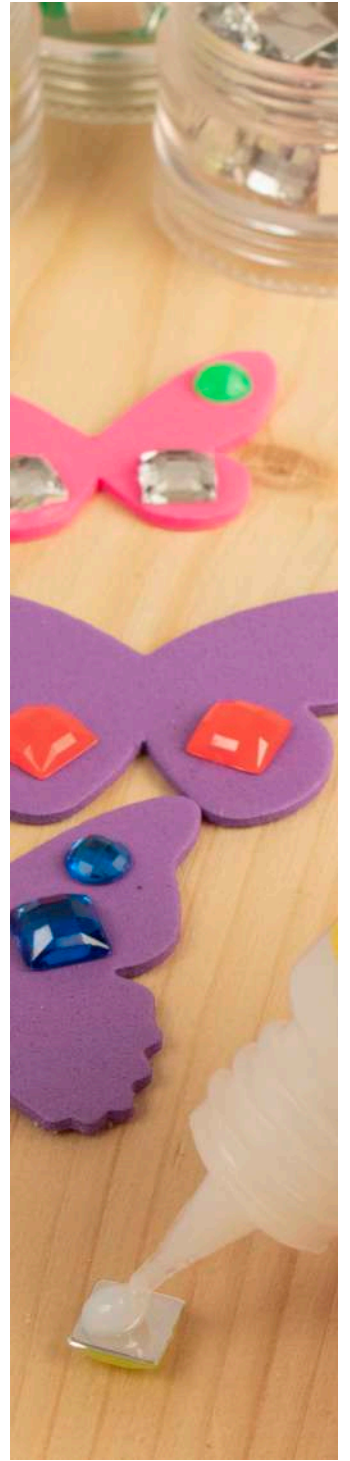

COLA MULTI SUPERFÍCIE · MULTI-SURFACE GLUE · COLLE MULTISURFACE

Especial para encolar gemas acrílicas decorativas, con base agua y secado transparente. Perfecta adherencia en todo tipo de superficies e incluso textil. Forma muy manejable y adaptable a las manos de los niños y los adultos.

Special for gluing decorative acrylic gems, with a base of water and transparent drying. Perfect adherence to all types of surfaces and even textiles. Very easy to use form, adaptable to the hands of children and adults.

Spéciale pour encoller les gemmes acryliques décoratives, avec une base eau et séchage transparent. Parfaite adhérence sur toutes surfaces inclut le textile. Forme maniable et qui s'adapte aux mains des enfants et adultes.



2005015
29ml.
🛒 5



	1	1	1
	5000u.	2000u.	1000u.
	5x8mm	8x13mm	10x14mm
	Z2200801	Z2201301	Z2201401
	Z2200802	Z2201302	Z2201402
	Z2200803	Z2201303	Z2201403
	Z2200804	Z2201304	Z2201404
	Z2200805	Z2201305	Z2201405
	Z2200806	Z2201306	Z2201406
	Z2200807	Z2201307	Z2201407
	Z2200808	Z2201308	Z2201408
	Z2200809	Z2201309	Z2201409

• Colores flúor · Fluor color · Couleurs fluor

maxi pack



2005013

5x8mm | 8x13mm | 10x14mm

1350u. aprox
 1

BOTE GOTAS ACRÍLICAS · ACRYLIC DROPS BOX
BOCAL GOUTTES ACRYLIQUES

Bote compuesto por gotas acrílicas de tres medidas y nueve colores distintas. Con más de 1.300 piezas para decorar un sinfín de proyectos.

Acrylic drops box composed of three sizes and nine different colors. With more than 1,300 pieces to decorate countless projects.

Bocal composé par des gouttes acryliques en trois mesures et neuf couleurs différentes. Avec plus de 1.300 pièces pour décorer une infinité de projets.





SET COLORES BÁSICOS GOTAS ACRÍLICAS · ACRYLIC DROPS BASIC COLORS SET · SET COULEURS BASE GOUTTES ACRYLIQUES

🛒 1



	2200811	2201311	2201411
	5x8mm	8x13mm	10x14mm
	(100u. x color) 600u. aprox	(40u. x color) 125u. aprox	(40u. x color) 100u. aprox

SET COLORES FLÚOR GOTAS ACRÍLICAS · ACRYLIC DROPS FLOUR COLORS SET · SET COULEURS FLUOR GOUTTES ACRYLIQUES

🛒 1



	2200812	2201312	2201412
	5x8mm	8x13mm	10x14mm
	(100u. x color) 600u. aprox	(40u. x color) 125u. aprox	(40u. x color) 100u. aprox



Botes enroscables y apilables para tener todas las gemas acrílicas bien ordenadas en tu craftroom.

Stackable containers with a thread to have all the acrylic gems neatly organized in your craftroom.

Pots à visser et empilables pour avoir les gemmes acryliques bien ordonnées dans votre craft room.





	1	1
	5000u.	500u.
	6x8mm	13x18mm

	Z2100801	Z2101801
	Z2100802	Z2101802
	Z2100803	Z2101803
	Z2100804	Z2101804
	Z2100805	Z2101805
	Z2100806	Z2101806
	Z2100807	Z2101807
	Z2100808	Z2101808
	Z2100809	Z2101809

• Colores flúor · Fluor color · Couleurs fluor

SET COLORES BÁSICOS OVAL ACRÍLICO · ACRYLIC OVAL BASIC COLORS SET · SET COULEURS BASE OVAL ACRYLIQUE

1



	2100811	2101811
	6x8mm	13x18mm
	(100u. x color) 600u. aprox	(25u. x color) 125u. aprox

SET COLORES FLÚOR OVAL ACRÍLICO · ACRYLIC OVAL FLOUR COLORS SET · SET COULEURS FLUOR OVAL ACRYLIQUE

1



	2100812	2101812
	6x8mm	13x18mm
	(100u. x color) 600u. aprox	(25u. x color) 125u. aprox



2005011
6x8mm | 13x18mm
 1080u. aprox
 1

BOTE OVALES ACRÍLICOS · ACRYLIC OVAL BOX
BOCAL OVALES ACRYLIQUES

Bote compuesto por ovals acrílicos de dos medidas y nueve colores distintos. Con más de 1.000 piezas para decorar un sinfín de proyectos.

Acrylic ovals box composed of two sizes and nine different colors. With more than 1,000 pieces to decorate countless projects.

Bocal composé par des ovals acryliques en deux mesures et neuf couleurs différentes. Avec plus de 1.000 pièces pour décorer une infinité de projets.



CORAZÓN ACRÍLICO · ACRYLIC HEART · COEUR ACRYLIQUE



	1	1
	1000u.	500u.
	10x10mm	14x14mm

	Z2301001	Z2301401
	Z2301002	Z2301402
	Z2301003	Z2301403
	Z2301004	Z2301404
	Z2301005	Z2301405
	Z2301006	Z2301406
	Z2301007	Z2301407
	Z2301008	Z2301408
	Z2301009	Z2301409

• Colores flúor · Fluor color · Couleurs fluor

SET COLORES BÁSICOS CORAZONES ACRÍLICOS · ACRYLIC HEARTS BASIC COLORS SET · SET COULEURS BASE COEURS ACRYLIQUES

1



	2301011		2301411
	10x10mm		14x14mm
	(40u. x color) 240u. aprox		(40u. x color) 200u. aprox

SET COLORES FLÚOR CORAZONES ACRÍLICOS · ACRYLIC HEARTS FLUOR COLORS SET · SET COULEURS FLUOR COEURS ACRYLIQUES

1



	2301012		2301412
	10x10mm		14x14mm
	(40u. x color) 240u. aprox		(40u. x color) 200u. aprox

BOTE CORAZONES ACRÍLICOS · ACRYLIC HEARTS BOX
BOCAL COEURS ACRYLIQUES

Bote compuesto por corazones acrílicos de dos medidas y nueve colores distintos. Con más de 700 piezas para decorar un sinfín de proyectos.

Acrylic hearts box composed of two sizes and nine different colors. With more than 700 pieces to decorate countless projects.

Bocal composé par des cœurs acryliques de deux mesures et neuf couleurs différentes. Avec plus de 700 pièces pour décorer une infinité de projets.

maxi pack



2005014
10x10mm | 14x14mm
 720u. aprox
 1



ARENA DE COLORES

—
COLOURED SAND

—
SABLE DE COULEURS



Packaging
Ref.

Bote
Box
Boîte

100gr
4



Packaging
Z+Ref.

Bote
Box
Boîte

600gr
4

SARENA

Los trabajos con arenas de colores nos ofrecen la divertida técnica de pintura sin pinceles. Para crear originales cuadros o para la decoración de soportes como la madera, metacrilato, cristal, papel, latón, etc. Para texturizar y crear relieves se pueden mezclar las arenas con pintura opaca o transparente, consiguiendo tonos pastel o manteniendo el color original. Muy apropiadas para manualidades infantiles o escolares.

The works with colored sands offer us the fun technique of painting without brushes. To create original paintings or for the decoration of supports such as wood, methacrylate, glass, paper, brass, etc. For texturizing and create reliefs, you can mix the sands with opaque or transparent paint, achieving pastel tones or maintaining the original color. Very suitable for children's or school crafts.

Les travaux avec des sables colorés nous offrent la technique amusante de peindre sans brosses. Pour créer des peintures originales ou pour la décoration de supports tels que le bois, le méthacrylate, le verre, le papier, le laiton, etc. Pour texturer et créer des reliefs, vous pouvez mélanger les sables à la peinture opaque ou transparente, obtenir des tons pastel ou maintenir la couleur originale. Très approprié pour l'artisanat d'enfants ou d'école.



SARENA NEÓN



Los colores pueden verse alterados por las limitaciones del proceso de impresión.

Colors may be altered due to limitations in the printing process.

Les couleurs peuvent être modifiées en raison des limitations du processus d'impression.



1760

Z1760

Brilla en la oscuridad
—
Glow in the dark
—
Brille dans l'obscurité



Para que brille hay que exponer la arena unos minutos a la luz.

To shine it needs a few minutes of light activation.

Pour qu'il brille il faut quelques minutes de lumière.



Técnica de aplicación en Arenas · Sand Application technique · Technique d'application pour sable



1 Coger una hoja adhesiva y dibujamos directamente sobre el papel protector.

Take a piece of adhesive paper and draw directly on to the protective backing paper.

Prendre une feuille adhésive et sur le papier protecteur nous pouvons réaliser le dessin directement.



2 Con un cutter cortar zonas, levantar el papel protector y verter un poco de arena extendiéndola con los dedos.

With a cutter cut around the design, remove the protective backing paper and pour a little sand over the sticky part spreading it around with your fingers.

Avec un cutter couper zones, lever le papier protecteur et verser un peu de sable en l'étalant avec les doigts.



3 Quitar la arena sobrante barriéndola con cuidado con una paletina.

Remove any leftover sand brushing it carefully with a spatula.

Enlevez le sable de trop en balayant doucement avec une truelle.



4 Continuar trabajando la hoja por zonas, siguiendo los pasos 2 y 3. Proteger con spray final acrílica.

Follow steps 2 and 3 for the rest of the sheet of paper, bit by bit. Protect with acrylic finish spray.

Continuez en travaillant la feuille par zone, suivants les pas 2 et 3. Protéger avec spray final acrylique.



HOJAS DE PVC ADHESIVO · ADHESIVE PVC FOIL · FEUILLES DE PVC ADHÉSIVES

PVC adhesivo 1 cara

Adhesive PVC 1 side

PVC adhésive 1 côté

Hojas 30x40cm
Foil 0,3mm
Feuilles 5u 1

Rollo 1,2 x 5m
Roll 0,3mm
Rouleau 1

PVC adhesivo 2 caras

Adhesive PVC 2 sides

PVC adhésive 2 côtés

Hojas 30x40cm
Foil 0,3mm
Feuilles 5u 1

Rollo 1,2 x 5m
Roll 0,3mm
Rouleau 1



1770



Z1770

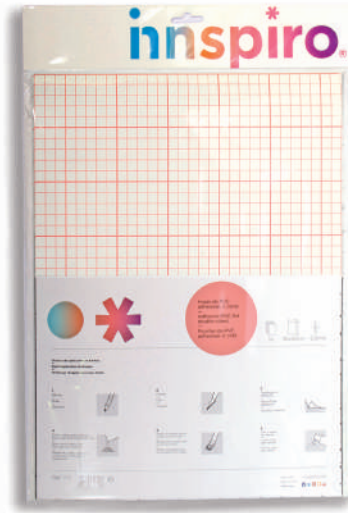

1771



Z1771

PRODUCTOS RELACIONADOS · RELATED PRODUCTS · PRODUITS ASSOCIÉS

Bases de corte

Cutting mat

Support de découpe

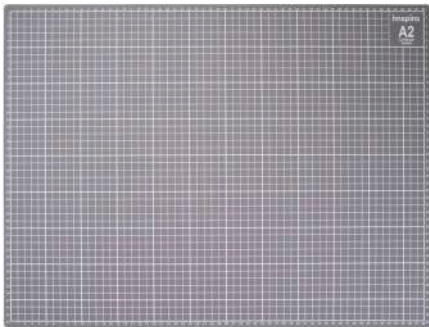

12166

A2 - 60x45cm



Lápiz cutter metálico +3 puntas

Metallic pencil with cutter point +3 blades

Cutter scalpel +3 lames



12101

17cm



Cutter grande

Large cutter

Cutter grand



12173

12



Paletina pony

Pony brush

Pinceau plat poney



71706

6cm



Barniz Zapon

Zapon varnish

Vernis Zapon



K840150

150ml



K840400

400ml



Recogedor

Scoop

Collecteur



24031

17cm







HOJAS PLÁSTICO MÁGICO INKJET

—
INKJET MAGIC PLASTIC SHEETS

—
FEUILLES PLASTIQUE MAGIQUE INKJET



Imprime en doble cara, 3 tamaños · Can be printed on double-face, 3 sizes
On peut imprimer double face, 3 tailles



52201

A4 (21x29,7 cm)



3u



1

Z52201

MAXI PACK - A4



30u



1

52202

A5 (14,8x21 cm)



6u



1

Z52202

MAXI PACK - A5



60u



1

52203

A6 (10,5x14,8 cm)



12u



1

Z52203

MAXI PACK - A6



120u



1



TRANSFIERE CUALQUIER IMAGEN DESDE TU IMPRESORA INK-JET AL PLÁSTICO MÁGICO · TRANSFER ANY IMAGE FROM YOUR INK-JET PRINTER TO MAGIC PLASTIC · TRANSFÉREZ N'IMPORTE QUELLE IMAGE DE VOTRE IMPRIMANTE INK-JET SUR LE PLASTIQUE MAGIQUE.



Imprimir ink-jet
Print ink-jet
Impression ink-jet



Cortar y hacer agujero
Cut and make a hole
Couper et faire un trou

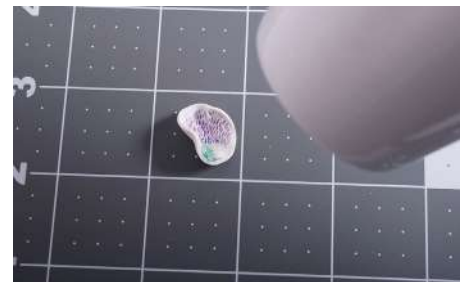

Aplicar pistola de calor
Apply heat gun
Appliquer un pistolet de chaleur

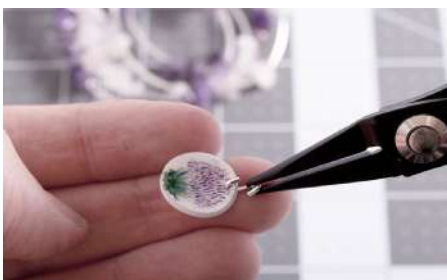

Colocar anilla
Insert a ring
Placer une anneau





CONSEJOS DE USO • USE TIPS • CONSEILS D'UTILISATION



Elige una imagen en tu ordenador.
Choose an image on your computer.
Choisissez une image dans votre ordinateur.



Imprimir foto en impresora de inyección de tinta.
Print photo with an inkjet printer.
Imprimez la photographie à l'aide d'une imprimante d'encre.



Cortar para dar la forma que se desee.
Cut to desired shape.
Découpez en donnant la forme que vous souhaitez.

175°C aprox.



Encoger la foto en el horno o con pistola de calor.
Shrink photo in the oven or with a heat gun.
Faire rétrécir la photo dans le four ou avec pistolet à chaleur.



Reduce un 50% su tamaño y aumenta 4 veces su grosor.
Shrink 50% in size and increase four times its thickness.
Rétrécissez 50% sa taille et augmentez quatre fois son épaisseur.



Es absolutamente vital ACLARAR/ILUMINAR todas las fotos para que parezcan muy PÁLIDAS Y DESCOLORIDAS, ya que los colores se intensificarán mucho cuando encojan. Para ello necesitarás un buen programa de edición de imágenes, el cual te será muy fácil de utilizar y del que te facilitamos el enlace web: <http://ipiccy.com/> así como los pasos de uso:

1. Clicar en "start editing" (iniciar edición).
2. Clicar en "upload photo" (subir foto).
3. Clicar sobre la foto elegida de tu biblioteca de imágenes y esta se abrirá en la página web de ipiccy.com.
4. Cuando el icono "camera" (cámara) aparezca resaltado, clicar la pestaña "exposure" (exposición).
5. Deslizar la barra "exposure" hacia la derecha para incrementar el brillo de la foto hasta un 50%.
6. Guardar tu foto haciendo clic en el icono "floppy disc" (disquete) que se encuentra en la parte superior.

A continuación volverás a tu biblioteca de imágenes.

NOTA: Sólo se guardarán los archivos jpeg.

It is absolutely necessary LIGHTEN/LIGHT UP all photos in order they seem PALER AND MORE FADED, since colors will be much intensified when they shrink. For that you will need a good image-editing program, which will be very easy to use. We provide the website link: <http://ipiccy.com/> as well as the step-by-step directions:

1. Click to "start editing".
2. Click to "upload photo".
3. Double-click on the selected image from your library of images and it will be opened on the ipiccy.com website.
4. When the camera icon appears highlighted, click to "exposure" window. Slide the "exposure" bar towards right in order to increase the image's brightness until 50%.
5. Save the image clicking on the "floppy disc" icon located at the top part. It will then come back to your library of images.

NOTE: It will only be saved jpeg files.

Il est absolument nécessaire ÉCLAIRCIR/ILLUMINER toutes les photos pour qu'elles ressemblent très PÂLES et DÉCOLORÉES, puisque les couleurs seront très intensifiées quand elles rétrécissent. Pour ça on aura besoin d'un bon programme d'édition d'images qui sera très facile à utiliser et duquel on le facilite le lien du web: <http://ipiccy.com/> ainsi que le pas à pas :

1. Cliquez sur «start editing» (commencer édition).
2. Cliquez sur «upload photo» (télécharger photo).
3. Double-cliquez sur la photo choisie de votre bibliothèque d'images et elle s'ouvrira sur le web ipiccy.com.
4. Quand l'icône «camera» (caméra) apparaisse souligné, cliquez sur l'onglet «exposure» (exposition). Glissez la barre «exposure» vers à droite pour incrémenter la luminosité de la photo jusqu'à 50%.
5. Gardez votre photo en cliquant sur l'icône «floppy disc» (disquette) qui se trouve à la partie supérieure. Ensuite elle retournera à votre bibliothèque d'images.

NOTE: Il se gardera seulement les fichiers jpg.



Para calcar o dibujar (con las blancas y las negras sólo podrá dibujar). Para colorear, cortar y encoger montones de SHRINKLES.

Blank Shrinkles plastic to draw on (only with white and black ones) or trace (with frosted). Colour, cut and shrink scores of SHRINKLES.

Pour calquer ou dessiner (avec les blanches et les noires, seulement on pourra dessiner). Pour colorier, couper et rétrécir plein de SHRINKLES.



Las hojas CRYSTAL CLEAR sólo aceptan rotuladores permanentes y dan un bonito efecto glaseado. Los lápices de colores, los rotuladores y accesorios no están incluidos.

CRYSTAL CLEAR sheets only accepted permanent marker pens for beautiful "stained glass" effects. Pencils and accessories not included.

Les feuilles CRYSTAL CLEAR n'acceptent que des feutres permanents et donnent un joli effet glacé. Les crayons de couleurs, les feutres et les accessoires ne sont pas inclus.

202x262mm 20u 1

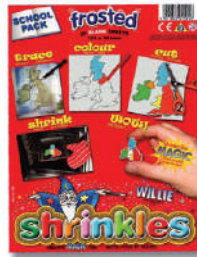

S1501
Frosted



S1502
White



S1503
Crystal Clear

101x131mm 50u 1



S1601
Frosted



S1602
White



S1603
Crystal Clear

SHRINK ART

Las hojas BLACK resultan fantásticas cuando se usan con rotuladores plateados y dorados y con lápices de colores claros y brillantes. Todas se pueden usar con tinta en sellos de estampación.

You can get some amazing results on BLACK sheets if you use silver or gold metallic pens or light/bright coloured pencils. You can also "rubber stamp" your images with permanent inks onto all nine materials.

Les feuilles BLACK donnent un résultat fantastique lorsqu'on utilise des feutres dorés ou couleur argent et crayons de couleurs claires et brillantes. Toutes peuvent être utilisées avec de l'encre sur timbres pour impression.

202x262mm 6u 1



S1301
Frosted



S1302
White



S1303
Crystal Clear



S1304
Black



S1306
Pastel Blue



S1307
Pastel Yellow

101x131mm 6u 1



S1701
Frosted



S1702
White



S1703
Crystal Clear



S1704
Black





kit

Cada Kit contiene 1 hoja con pre-diseños, 4 lápices y 6 accesorios: 1 llavero, 1 tope para lápiz, 1 colgante móvil, 1 imán 1 aguja broche y 1 soporte.

Each kit contains 1 sheet with pre-designs as well as 4 pencils and 6 accessories: 1 key ring, 1 pencil top, 1 hanging mobile, 1 magnet, 1 brooch pin and 1 medium.

Chaque kit contient 1 feuille avec pré-dessins en plus de 4 crayons et 6 accessoires: 1 porte-clés, 1 capuchon du crayon, 1 pendentif mobile, 1 aimant, 1 épingle et 1 support.

3

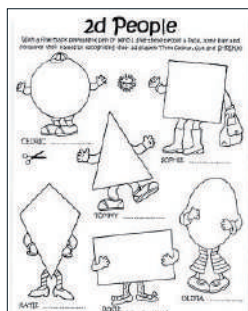

S1060-01
2d People

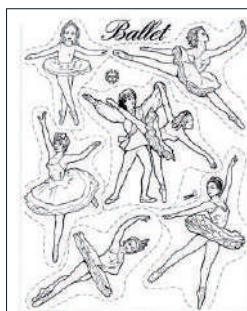

S1060-02
Ballet



S1060-03
Beano



S1060-04
British wildlife

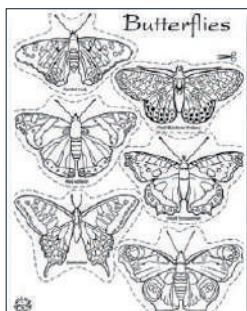

S1060-05
Butterflies



S1060-06
Christmas



S1060-07
Clowns



S1060-08
Crazy cars



S1060-09
Crazy catz



S1060-10
Cute kittens

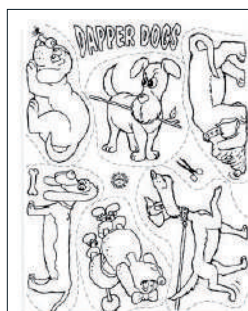

S1060-11
Dapper dogs



S1060-12
Dinosaurs



S1060-13
Dolphins



S1060-14
Easter



S1060-15
Expressions



S1060-16
Eye flyers



S1060-17
Fairy Tales



S1060-18
Farm friends



S1060-19
Fighter planes



S1060-20
Fish



S1060-21
Frankenstein



S1060-22
Girlz



S1060-23
Henry VIII



S1060-24
Jacqueline Wilson's
Totally Tracy



S1060-25
Jungle fun



S1060-26
Knights



S1060-27
Manga faces



S1060-28
Manga fairies



S1060-29
Motorbikes



S1060-30
Pets



S1060-31
Pirates



S1060-32
Playful puppies



S1060-33
Ponies



S1060-34
Rock Chicks

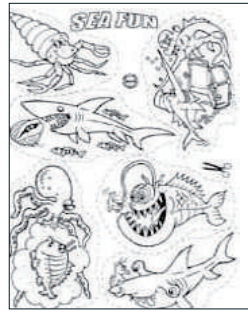

S1060-35
Sea fun



S1060-36
Soccer look-a-likes



S1060-37
Space



S1060-38
Sports

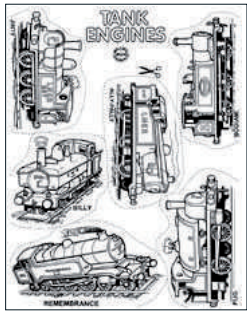

S1060-39
Tank engines



S1060-40
Jacqueline Wilson's
Best Friends



Dibujos pre-impresos ¡No se necesitan sellos de estampación! Simplemente con colorear, cortar y encoger se pueden adornar tarjetas, libros, papelería, bisutería, etc.. Diseños variados y bonitos en cada hoja.

No need to buy rubber stamps - these are pre-printed! Simply colour, cut and shrink to embellish your greetings cards, bags, tags, scrap books, stationery and jewellery. Great fashionable items all on one sheet.

Dessins pré imprimés. N'ont pas besoin de timbres d'impression. Vous pourrez décorer vos cartes, livres, papeterie, bijouterie etc... simplement en coloriant, en coupant et en rétrécissant. Différents dessins modernes et beaux dans chaque feuille.

202x262mm 3



S2001

Angels from hell



S2002

Art Deco



S2003

1930's Beauty culture



S2004

1930's Beauty salon



S2005

Female fashion



S2006

Nice little girls



S2007

Surfer / Skateboard



S2008

Football / Basketball



S2009

Schoolboy / Skater



S2010

Ballet fairy



S2011

Fashion / Disco



S2012

Schoolgirl / pony



S2013

Fishing / Golf



S2014

Gardening / Rugby



S2015

Football / Cricket



S2016

Crafters / Party lady



S2017

New mun / Keep fit



S2018

Shopping / Gardening



S2019

Flowers

1. DIBUJAR cualquier imagen sobre la parte rugosa.
2. COLOREAR ligeramente la cara áspera del plástico con lápices de color.
3. CORTAR el plástico de una forma aproximada, dejando un borde alrededor del dibujo. Luego perforar un agujero con una perforadora de papel, si va a hacer un ornamento para un llavero.
4. ENCOGER. Precalentar el horno a 175°C y colocar el plástico en una bandeja de cocinar forrada con papel de aluminio. Se retorcerá, ESPERAR HASTA QUE QUEDE PLANO. Quedará flexible y habrá encogido totalmente. Sacar el plástico del horno con un guante y ponerlo en una mesa cubriéndolo inmediatamente con un libro o algo similar para mantenerlo plano por unos instantes mientras se endurece.
5. ¡SENSACIONAL! Su figura será un 60% más pequeña y 4 veces más gruesa, lista para utilizarla cómo se desee.

-
1. DRAW any picture onto the rough side.
 2. COLOUR the rough side of the plastic lightly with coloured pencils.
 3. CUT the plastic to shape (not intricately), leaving a border all round. If you plan to attach an accessory later, please clip a hole with a paper punch now.
 4. Pre-heat the oven to 175°C (350°F), and place the plastic on a cool baking tray lined with tin foil. Use an oven glove and carefully pop it in the oven for a few minutes. It will twist, WAIT UNTIL IT LIES FLAT. It will then be pliable and fully shrunk. Using an oven glove, carefully remove the plastic from the oven; place it on worktop and immediately hold it flat under a table mat or book for a few moments and it set hard.
 5. WOW! Now your picture is 60% times smaller, 4 times thicker and you can attach an accessory to it.

-
1. DESSINE un motif de ton choice sur le côté poncé de la feuille.
 2. COLORIE légèrement le côté rugueux du plastique avec des crayons de couleur.
 3. DÉCOUPE le plastique en laissant un bord tout autour du dessin. Si tu veux attacher un accessoire plus tard, faire un trou maintenant avec une poinçonneuse.
 4. RÉTRÉCIR. Allumer à l'avance le four à 175°C. Poser le plastique sur la plaque de cuisson recouverte d'une feuille d'aluminium. Utiliser un gant de four et poser soigneusement le plastique dans le four pour quelques minutes. Il se tord: ATTENDS QU'IL REDEVIENT PLAT puis il sera flexible et complètement rétréci. Utiliser un gant de four et enlever soigneusement le plastique du four, pose le sur la table et aplatit le tout de suite sous un livre pour un moment et il deviendra dur.
 5. SENSASS! Maintenant ton image est 60% plus petite, 4 fois plus épaisse et tu peux y attacher un accessoire.





Las cajas Kit contienen muchos Shrinkles pre-impresos además de 2 Shrinkles lisos (uno blanco para dibujar y otro efecto FROSTED o glaseado para calcar cualquier dibujo) para colorear, cortar y encojer.

Se incluyen los accesorios:

11 lápices de colores y 1 negro para dibujar, anilla llavero, anillo llavero y gancho, 1 aguja broche, 1 cierre, 1 cadena bolas, 1 tira magnética (para hacer 4 imanes nevera), 1 tira adhesivos doble cara, 1 bolsa broches aguja plástico colores, 1 cilindro goma, 1 tope lápiz, 1 base anillo, pernos plástico colores, soportes figuras, 12 tuercas para hacer Shrinkles 3D y 12 anillas para hacer cadena o brazaletes.

Most of the BUMPER BOXES contain lots of pre-printed Shrinkles plus 2 blank Shrinkles (one is white for drawing and the other is frosted for tracing any picture) for colouring, cutting and shrinking.

Included Accessories:

11 coloured pencils and a black tracing pencil, a key ring, a key ring and hook, a brooch pin, a zip pull, a ball chain to make a luggage tag, a magnet strip (makes 4 fridge magnets), a sticky pad strip, a badge back and pin, a noodle, a pencil topper, a finger ring, a snapper/pendant back, 2 stand-ups to make figurines, 2 nuts and bolts to make 3-D Shrinkles and 2 links to make a bracelet or a chain.

Les boîtes Bumper contiennent beaucoup de Shrinkles pré- impression en plus de 2 Shrinkles lisses (un blanc pour dessiner et un autre effet FROSTED ou glacé afin de pouvoir calquer tout dessin) pour colorier, couper et rétrécir.

Accessoires inclus:

11 crayons de couleurs et 1 noir pour dessiner, anneau porte-clés, anneau porte-clés et crochet, 1 aiguille broche, une fermeture, 1 chaîne boules, 1 bande magnétique (pour créer 4 aimants pour frigo), 1 bande adhésive double face, broches aiguille plastique couleurs, 1 cylindre gomme, 1 crayon tampon, 1 base bague, boulons plastique couleurs, supports figures, 12 vis pour faire Shrinkles 3D et 12 anneaux pour faire une chaîne ou un bracelet.



S1416

Wayside and Alphabet



S1417

Vampiros



S1420

Ballet



S1421

The Wind in the Willows



S1425

Formula One



S1426

Spring and Summer



S1427

Garden and trees

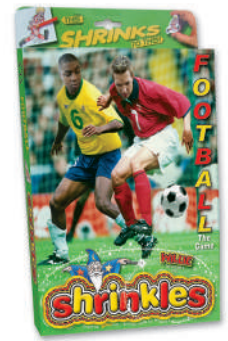

S1429

Football



S1431

Wacky Word Creator

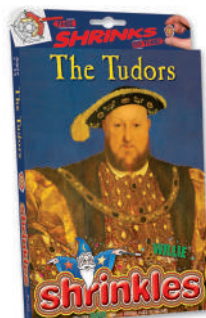

S1432

The Tudor



S1434

Dolphins



S1435

Rose Petal Angels



S1436

Jaqueline Wilson's Best Friends



S1437

Space

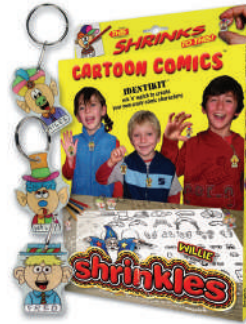

S1438

Cartoon Comics



S1439

Crazy Cats



S1441

Jaqueline Wilson's Totally Tracy



S1442

Pirates



S1443

Wiggly Eyed Bugs



S1444

Wiggly Eyed Jungle Fun



S1446

Knights and Dragons



S1447

Manga Fairies



S1448

Sports



S1449

Beano



S1450

Lucky Box



S1451

Girls with Bling



S1452

Manga Rock Chicks with Bling

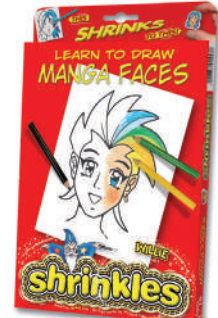

S1453

Learn to Draw Manga Faces



CAJAS KIT · BUMPER BOXES · BUMPER BOÎTES



S1454

Woodland Wildlife



S1060-08

Wiggly Eyed Crazy Cars



S1459

Motor Bikes

BOLSA KIT CADENAS · CHAIN COLLECTOR SET · CHAINES SACHET KIT



kit

Cada Kit contiene 1 hoja con pre-diseños, 4 lápices y 35 anillas.

Each kit contains 1 sheet with pre-designs as well as 4 pencils and 35 rings.

Chaque kit contient 1 feuille avec pré-dessins en plus de 4 crayons et 35 anneaux.

3



S1062-40

Dinkie Bugs



S1062-41

Heart to heart



S1062-42

Friendship bracelet



S1062-43

Santa's faces



PAPEL DECORATIVO PARA DÉCOUPAGE

—
DECORATIVE PAPER FOR DECOUPAGE

—
PAPIER DÉCORATIVE POUR DÉCOUPAGE



50x70cm - 85gr/m2  10

EXPOSITOR para 32 modelos · DISPLAY for 32 models
PRÉSENTOIR pour 32 modèles



13000



13001



13002



13003



13004



13005



300179

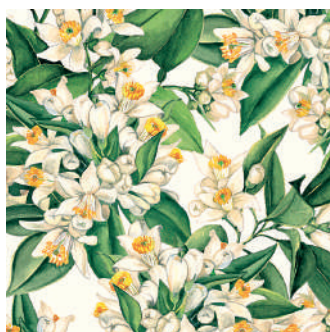

300182



Expositor vacío · Empty display · Présentoir vide

EXP100-87100

189x78x67cm



300263



300183



300205



300163



300162



300164



301730



300676

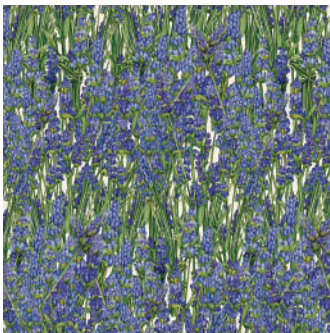

301731



301729



300222



300220

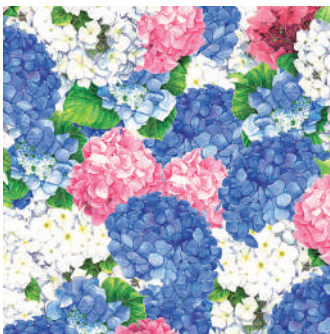

300221



300218



301727



301726



300305



300304



300127



301618



300171



301728



300219



300110



301712



301719



300303



301674



300170



301718



300201



300132



301745



300207



300119



300118



300126



300178



300133

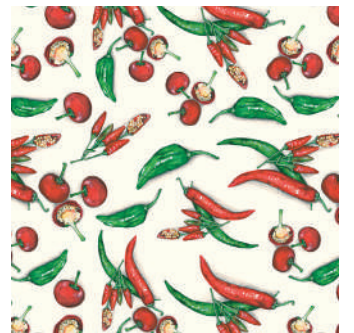

300184



301734



301735



300259



301698



301697



301624



301694



300125



301616

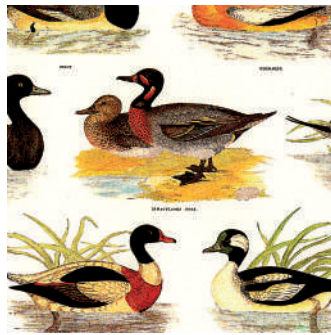

301619

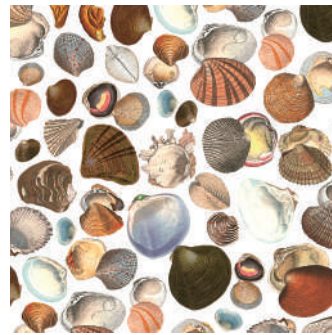

300308



300165



301717



300168

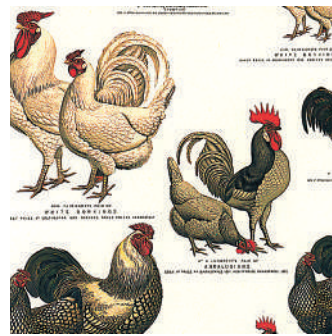

301721



301732



301737



301736



300224



300128

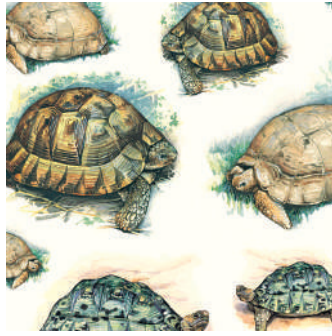

300209



300158



300140

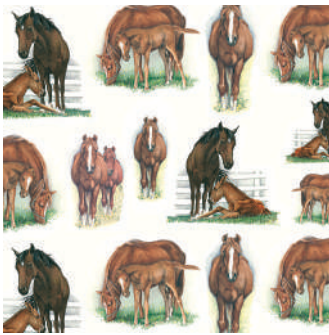

300159



300166



300167



301699



301700



300223

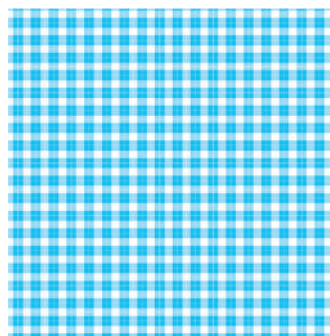

300584

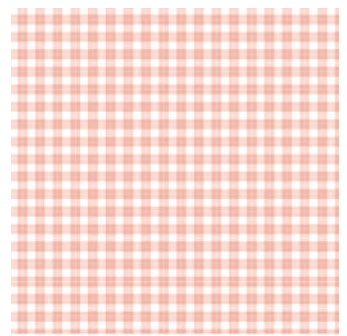

300585



300176



301738



300202



300169



300228



300227



300204



301630



300612



300175



300174



301720



300197



300199



300172



300610



300503



300212



300208



300582

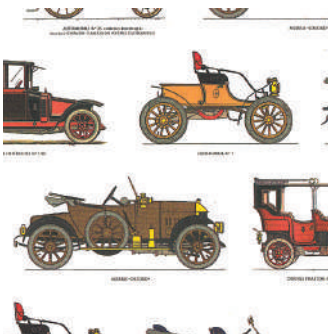

301673



301742



301725



300225



300238



300226



300153

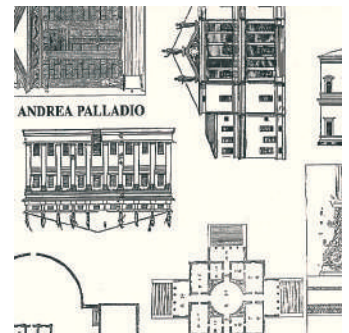

301646



300264



300554



301724

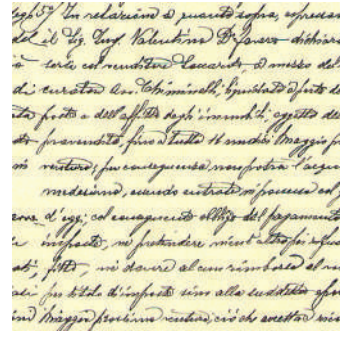

300560

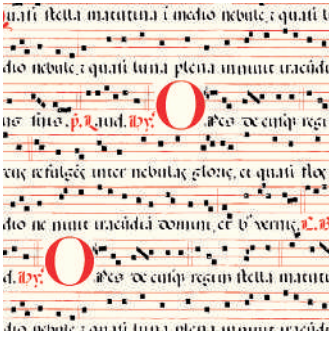

300130

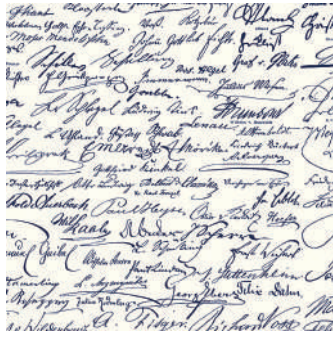

300229



300240

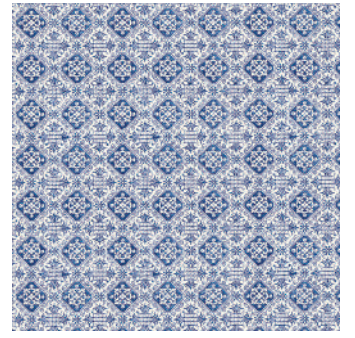

300230





307114

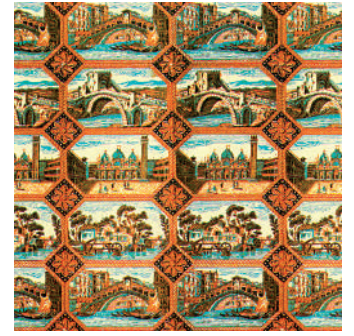

301614



307113

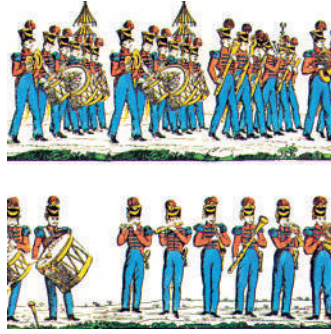

307110



300113



307214



307115

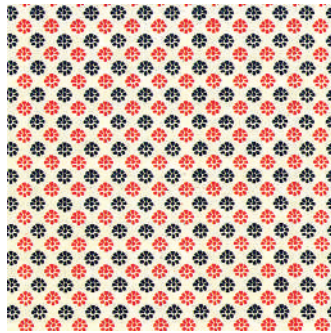

300092



307116

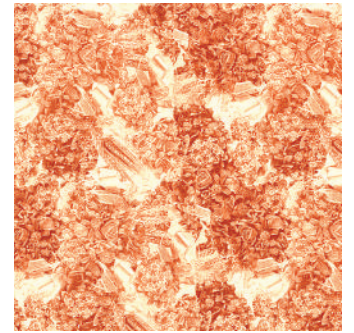

301714

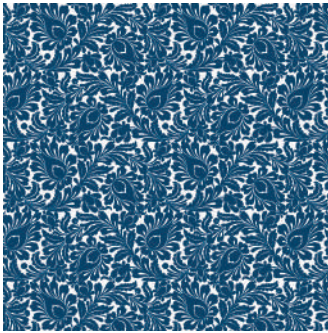

300306

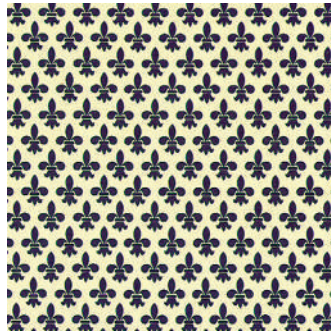

301660

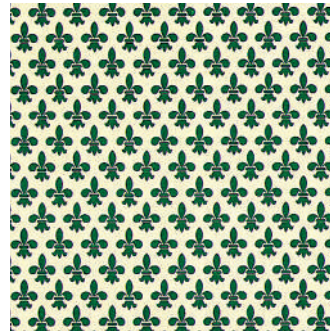

301661

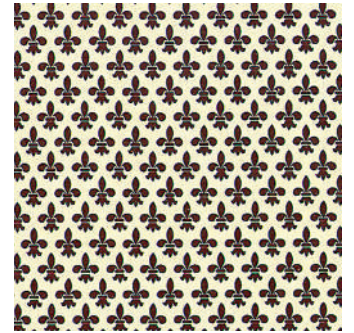

301662

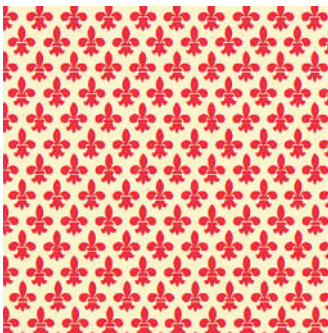

301663

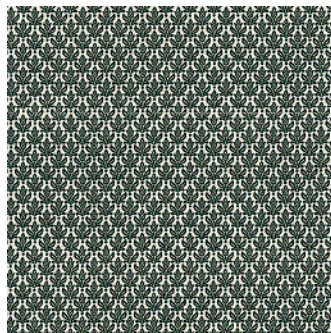

300566



307121



307122



307124

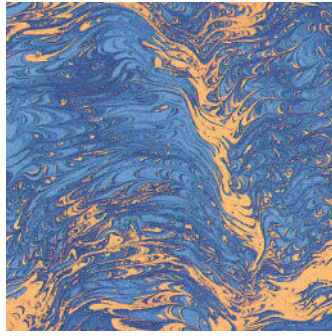

300351

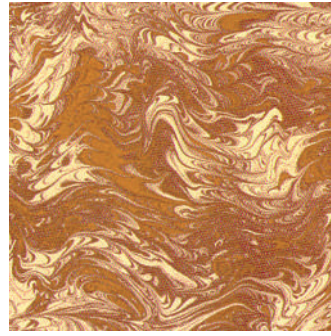

300356

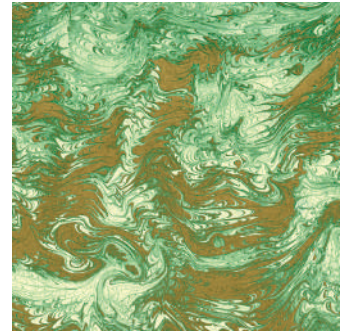

300357

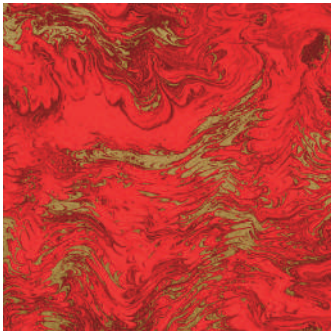

300354



301741



301711



300216



300215



300217



300257



300191





300189



300190



301637



300149



300154



300192



300210

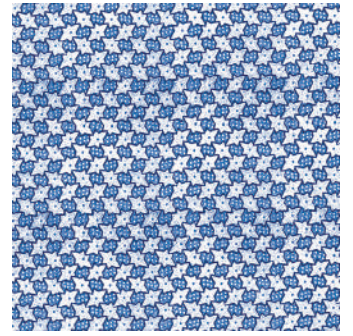

300255

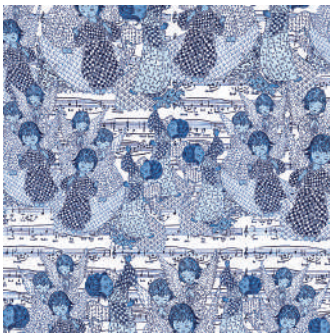

300256



300214



301672



301671

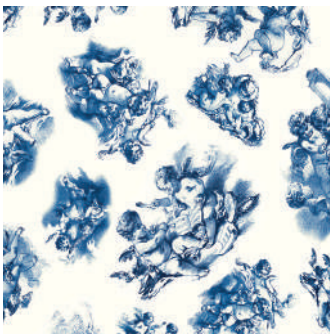

300157



301642



301636



300138



300160

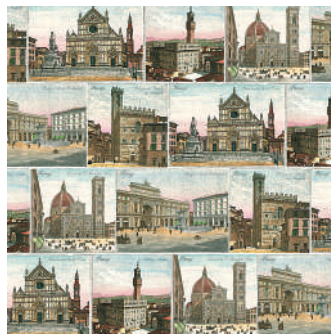

300135



300161



300206



300247



300235



300236



300248



300309



300310



300311



300312



300313



300314



300315



300316



300317



300318



301664



301665



300186



300319



300321



300322



300324



300325



300326

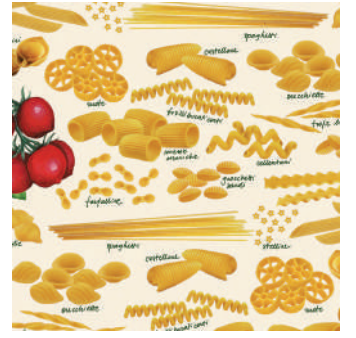

300327



300328



300329



300330

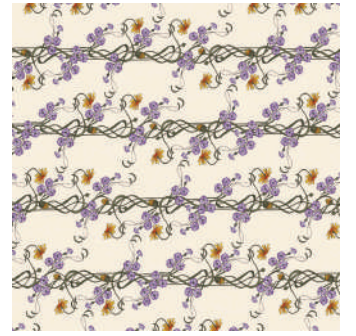

300335



300336

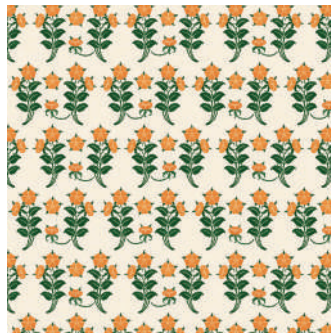

300337



300338



300339



300345



300346

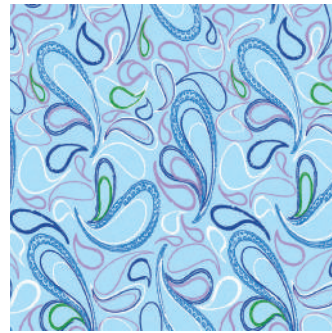

300347



300501



300563



300564



300571

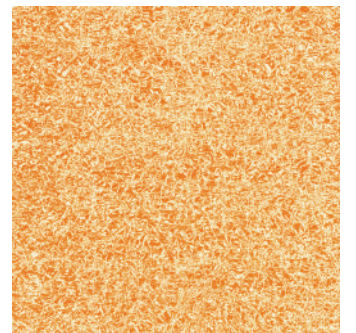

300572



300574

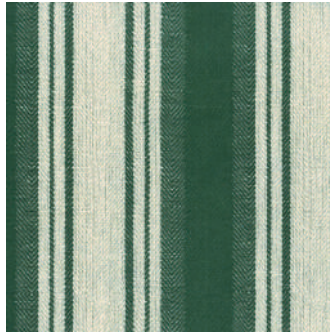

300578



300674



300697



300698



300699



301722

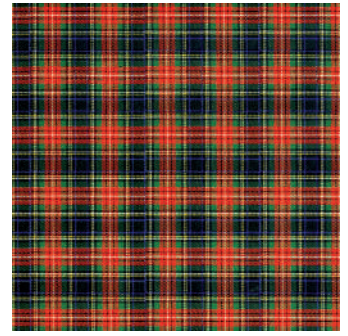

300265



300458



300459

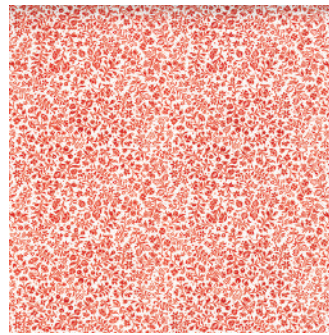

300464

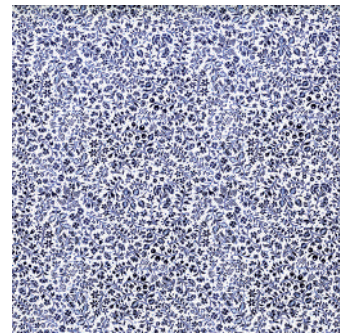

300465





PACK SURTIDOS - PAPEL 30x30cm

—
ASSORTED PACKS - PAPER 30x30cm

—
PACKS ASSORTIES - PAPIER 30x30cm

GRAPHIC 45 - PACK 250u.



maxi pack

50 modelos surtidos
5 papeles/modelo

GRAPHIC45-250
30x30cm - 176gr/m2

250 1



BASIC GREY - PACK 250u.



maxi pack

50 modelos surtidos
5 papeles/modelo

BASICGREY-250
30x30cm - 176gr/m2

250 1





Paper + Design

tabletop®

innspiro®

Distribuye las servilletas decoradas de la marca PAPER & DESIGN.
Diseños muy actuales con gran calidad de impresión especial para la técnica de découpage con servilletas.

—
Distribute the decorated napkins of the PAPER & DESIGN brand.
Very up-to-date designs with high print quality especially for découpage technique with napkins.

—
Distribuez les serviettes décorées de la marque PAPER&DESIGN.
Designs très actuels avec une grande qualité d'impression spéciale pour la technique de découpage avec serviettes.

TODAS LAS SERVILLETAS EN LA WEB
ALL NAPKINS ON THE WEB
TOUTES LES SERVIETTES SUR LE SITE



[B2B.INNSPIRO.COM](https://www.b2b.innspiro.com)



PAPER & DESIGN

SERVILLETAS · NAPKINS · SERVIETTES



20

SCAN



Si deseas tener el catálogo en tus manos, solicítalo. O si lo prefieres en formato virtual; escanea el código QR y visualízalo.

If you want to have the catalog in your hands, request it. Or if you prefer it in virtual format; scan the QR code and view it.

Si vous souhaitez obtenir le catalogue, demandez-le-nous. Ou si vous le préférez en virtuel ; scannez le code QR afin de pouvoir le visualiser.

PARA DÉCOUPAGE CON LA TÉCNICA DE LA SERVILLETA

FOR DECOUPAGE WITH THE NAPKIN TECHNIQUE · POUR DÉCOUPAGE AVEC LA TECHNIQUE DE LA SERVIETTE



01

Sobre superficies porosas; madera, cartón...
On porous surfaces; wood, cardboard...
Sur surfaces poreuses; bois, carton...

02

Sobre textil
On textile
Sur textile

03

Sobre porcelana y cristal
On porcelain and glass
Sur porcelaine et cristal



04

Para eventos
For events
Pour fêtes



05

Para cumpleaños
For birthdays
Pour anniversaires



06

Para decoración
For decoration
Pour décoration



MADERA

—
WOOD

—
BOIS

CAJAS DE PINO MACIZO · SOLID PINE BOXES · BOÎTES DE PIN MASSIF

🛒 2



9102

8,5x8,5x5cm



9103

12x12x8cm



9106

17x11x7cm



9108

15x11x3,5cm



9115

23x8x5cm



9112

20x10,5x3,5cm

BAÛLES DE PINO MACIZO · SOLID PINE CHESTS · BAHUTS DE PIN MASSIF

🛒 2



9500

10x7x6cm



9600

12x9x7cm



9700

14x9x8cm



9800

17x11x8cm

CAJAS CON CIERRE · BOXES WITH CASP · BOÎTES AVEC FERMOIR

🛒 1



257

32x26x8cm



258

42x32x8cm

CAJAS CUADRADAS · SQUARE BOXES · BOÎTES CARRÉES



2002

8,5x8,5x5cm 🛒 4



2003

12x12x8cm 🛒 2



9117

12x10,5x7cm 🛒 2

CAJAS HEXAGONALES

HEXAGONAL BOXES · BOÎTES HEXAGONALES



CAJAS CON MARCO · BOXES WITH RAISED EDGES · BOÎTES AVEC CADRE

🛒 2



7901

int. 5x5cm
ext. 6,5x6,5cm



7902

int. 5x10cm
ext. 6,5x11,5cm



7903

int. 10x10cm
ext. 11,5x11,5cm



PORTALÁPICES Y PINCELES · PENCIL AND BRUSH HOLDERS · PORTE CRAYONS ET PINCEAUX

🛒 2



9100

8,5x8,5x9cm



13

23x8x5cm



14

36x8x5cm



21527

32x20x15cm

🛒 2

21529

24x13x10cm

🛒 4

21530

20x9,5x7,5cm

🛒 4



603

38x12x10cm 🛒 1

+i

Con separadores interiores
With inner dividers
Avec séparateurs intérieurs

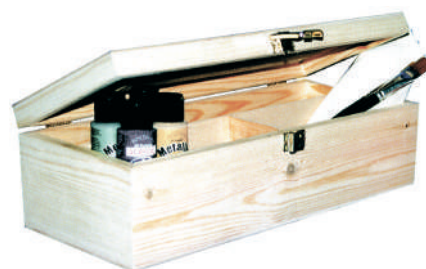

602

38x20x12cm 🛒 1





CAJAS DE PINO MACIZO Y CHAPA · SOLID PINE AND VENEER BOXES · BOÎTES DE PIN MASSIF ET CONTREPLAQUÉ

2



2
14x9,5x7cm



5
15x11x3,5cm



6
16x12x5cm



8
22x15x7cm



10
25x19x7cm



11
29x21x7cm

CAJA LIBRO · BOOK BOX · CAISSES LIVRE



21549
28x18,5x18,5cm 1



21545	27,7x18,8x8,5cm	4
21547	17,7x11,5x5,5cm	4
21548	12,5x8x4cm	4

CAJONERAS · BENCHES · TIROIRS

1



220
30x13x28cm



221
25x13x33cm



CAJAS DE CHAPA · VENEER BOXES · BOÎTES CONTREPLAQUÉ



97031	16x16x12cm	2
97033	14x14x10cm	2
97035	12x12x8cm	2
97037	10x10x6cm	6
97039	8x8x4cm	6



97041	14x17cm	2
97043	12x15cm	2
97045	10x13cm	2
97047	8x11cm	6
97049	6x6cm	6



CAJA REDONDA CON ASA · ROUND BOX WITH HANDLE · BOÎTE RONDE AVEC ANSE



97050	22x12cm	2
97051	20x11cm	2
97053	16x9cm	2
97055	12x7cm	2
97057	9x5cm	6
97059	6x3cm	6



97060	22x10x5cm	2
97062	15x8x3cm	4

21644	Ø 22x26cm	1
-------	-----------	---

ESTUCHES DE CHAPA · VENEER BOXES · BOÎTES CONTREPLAQUÉ



21554	9,5x33cm	2
-------	----------	---



21551	17,5x14x4,7cm	6
21552	15x11x3,7cm	6
21553	12x8x2,7cm	6



CAJAS Y COMPLEMENTOS CON CRISTAL · BOXES AND COMPLEMENTS WITH GLASS TOP · BOÎTES ET ACCESSOIRES AVEC VERRE

Cajas con cristal desmontable para poder aplicar sus trabajos: punto de cruz, flor seca, ganchillo, seda, etc..

Boxes come with detachable glass so that artwork such as cross stitch, dried flowers, crochet or silk art.

Boîtes vont avec un verre détachable pour pouvoir appliquer vos travaux: point croix, fleur sèche, travail de crochet, soie, etc...



CAJA PARA TÉ

TEA BOX · BOÎTE POUR THÉ



7632

16x16x6cm

CAJA PARA SERVILLETAS

NAPKIN BOX · BOÎTE POUR SERVIETTES



7630

20x20x9cm

RELOJ · CLOCK · HORLOGE



7715

27x27cm

CAJAS CUADRADAS · SQUARE BOXES · BOÎTES CARRÉS



7624

16x16x8,5cm



7625

20x20x8,5cm

CAJAS CON SEPARADORES · BOX WITH SEPARATORS · BOÎTE AVEC SÉPARATEURS



7626

29,5x12,5x8,5cm



VITRINAS EXPOSITOR · DISPLAY CASES · BOÎTES VITRINES



209

33x22x5,5cm



210

17,5x17,5x4,5cm



213

30x19x4cm



212

32x32x10cm



Dos estantes
Two shelves
Deux étagères



COSTUREROS · SEWING BOXES · NÉCESSAIRE DE COUTURE

🛒 1



201
16,5x25x20cm



21570
34x20x31cm



244
31x23x14cm



200
15x28x25cm

CLASIFICADOR · CLASSIFIER · CLASSIFIER

🛒 2



21518
16x10x19cm



21615
15x10,5x18cm

CARRETILLAS · WHEELBARROWS · BROUETTES

🛒 4



21621
19x11,5x8cm



21622
26,5x11,2x10cm

ARMARIO LLAVES · KEY CUPBOARD · ARMOIRE CLÉS

🛒 2



21623
13x5x21,5cm



21624
17x5,5x20cm



21625
15x5x20cm

CAJAS PAÑUELOS · TISSUE BOX · BOÎTE MOUCHOIRS

🛒 1



21565
25x12x7cm



BANDEJAS RECTANGULARES · RECTANGULAR TRAYS · PLATEAUX RECTANGULAIRE



21581	46x36x6cm	1
21583	40x30x6cm	2
21585	34x24x6cm	2
21587	28x18x6cm	2



BANDEJAS REDONDAS · ROUND TRAYS · PLATEAUX RONDES



21601	Ø 40x8,5cm	1
21602	Ø 37x8cm	1
21603	Ø 34x7,5cm	1
21605	Ø 28x6,5cm	2
21607	Ø 22x5,5cm	2
21609	Ø 16x4,5cm	4
21611	Ø 10x3,5cm	4

21600 Set 11 medidas · Set 11 sizes · Set 3 tailles



BANDEJA OVAL CONJUNTO 3 MEDIDAS · OVAL TRAY SET 3 SIZES · PLATEAU OVALE SET 3 TAILLES



21626	19x34x5cm	1
	25x40x6cm	
	30x45x7cm	



7961
30x40x4cm



7962
24x30x4cm



7964
40x30x2,5cm

BANDEJAS CON CRISTAL · TRAYS WITH GLASS TOP · PLATEAUX AVEC VERRE

JUEGO 3 BANDEJAS · 3 TRAYS SET · SET 3 PLATEAUX



261 30x40x4cm 1
262 24x30x4cm 1



21556 37x27x8cm
32x22,5x7cm
29x19,5x5,5cm



21557 40x28,5x8,5cm
35x24x7,5cm
32x21x6,5cm



REVISTERO · MAGAZINE RACK · PORTE-REVUES



4235
38x14x36cm

PARAGUERO · UMBRELLA STAND · PORTE-PARAPLUIES



4102
21x21x43cm

CAJA · BOX · BOÎTE



219
18x13cm

MACETA · FLOWER POT · POT À FLEURS



21568
35x21,5x21cm

RELOJ CON CRISTAL · CLOCK BOXES WITH GLASS · HORLOGES AVEC CRISTAL

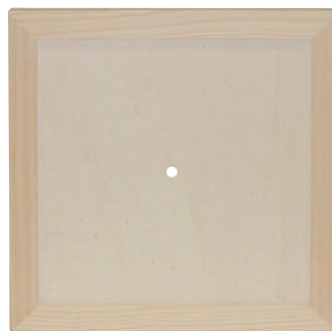

7615
27x27cm



7616
27x29cm

JUEGO 3 CESTAS · SET 3 BASKETS · SET 3 PANIERS



21566
26,5x20x14cm - 21x15x12cm - 15x11x11cm





OVALADAS · OVAL · OVAL

4010	inf. 16x9cm / sup. 14x7cm	2
4012	inf. 22x11cm / sup. 20x9cm	2
4014	inf. 29x14cm / sup. 27x12cm	2
4016	inf. 36x18cm / sup. 34x16cm	1



REDONDAS · ROUND · ROUNDS

4018	inf. Ø8cm / sup. Ø6cm	4
4019	inf. Ø9cm / sup. Ø7cm	4
4020	inf. Ø12cm / sup. Ø10cm	2
4021	inf. Ø16cm / sup. Ø14cm	2
4022	inf. Ø19cm / sup. Ø17cm	2
4023	inf. Ø22cm / sup. Ø20cm	1
4024	inf. Ø24cm / sup. Ø22cm	1
4026	inf. Ø29cm / sup. Ø27cm	1



RECTANGULARES · RECTANGULAR · RECTANGULAIRES

4030	inf. 14x9cm / sup. 12x7cm	2
4032	inf. 18x11cm / sup. 16x9cm	2
4034	inf. 24x14cm / sup. 22x12cm	2
4036	inf. 30x18cm / sup. 28x16cm	1



ELÍPTICAS · ELLIPTICAL · ELLIPTIQUES

4050	inf. 16x9cm / sup. 14x7cm	2
4052	inf. 22x11cm / sup. 20,5x9cm	2
4054	inf. 29x14cm / sup. 27x12cm	2
4056	inf. 36x18cm / sup. 34x16cm	1



103	125x75cm	1
-----	----------	---



MARCOS DE MADERA DE PINO MACIZO · SOLID PINE FRAMES · CADRES EN BOIS DE PIN MASSIF

Portafotos

Photo frames

Porte-photos



G230-03	10x15cm
G230-04	13x18cm
G230-06	18x24cm
G230-09	30x40cm

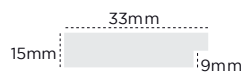

G231-03	10x15cm
G231-04	13x18cm
G231-06	18x24cm
G231-09	30x40cm

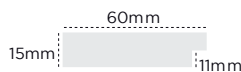

G232-03	10x15cm
G232-04	13x18cm
G232-06	18x24cm
G232-08	24x30cm
G232-09	30x40cm

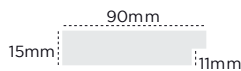

G233-03	10x15cm
G233-04	13x18cm
G233-06	18x24cm
G233-08	24x30cm
G233-09	30x40cm



G3-03	10x15cm
G3-04	13x18cm
G3-06	18x24cm
G3-09	30x40cm





TEXTIL ALGODÓN

COTON TEXTIL

TEXTIL COTTON



Packaging Ref.

Bolsa
Bag
Sachet



Packaging Z + Ref.

Granel
Vrac
Bulk

TEXTIL ALGODÓN · COTON TEXTIL · TEXTIL COTTON

Bolsa gafas, cierre velcro
Glasses pouch velcro closure
Étui à lunettes fermeture velcro
TWILL | 270gr/m²
65% POLY 35% COTTON



90205 9x18cm 1u. 10
Z90205 50u. 1

Mini bolsa
Double-handled gift bag
Mini sac
TWILL | 270gr/m²
65% POLY 35% COTTON



92634 13x18x5cm 1u. 10
Z92634 50u. 1

Mini bolsa
Double-handled gift bag
Mini sac
TWILL | 270gr/m²
65% POLY 35% COTTON



92639 10x15cm 1u. 10
Z92639 50u. 1

Monedero mochila
Knapsack purse
Porte-monnaie sac à dos
CANVAS | 226gr/m²
100% COTTON



92652 8x10x13cm 1u. 10
Z92652 50u. 1

Monedero redondo
Round purse
Porte-monnaie rond
CANVAS | 226gr/m²
100% COTTON



92653 8,5x3cm 1u. 10
Z92653 50u. 1

Necesar
Wash bag
Trousse de toilette
CANVAS | 226gr/m²
100% COTTON



92662 15x9x5cm 1u. 5
Z92662 50u. 1

Bolsa cosmética interior forrado
Lined makeup bag
Bourse cosmétique couverte
CANVAS | 226gr/m²
100% COTTON



90202 19x14x8cm 1u. 5
Z90202 50u. 1

Estuche lápices
Pencil case
Trousse à crayons
CANVAS | 340gr/m²
100% COTTON



92651 Ø7x22cm 1u. 10
Z92651 50u. 1

Bortapinceles
Brushes bag
Trousse pour pinceaux
CANVAS | 226gr/m²
100% COTTON



92650 43x40x18cm 1u. 1
Z92650 50u. 1

Gorra infantil
Child's cap
Casquette infantile
TWILL | 200gr/m²
100% COTTON



90021 54cm 1u. 5
Z90021 50u. 1

Gorra adulto
Adult's cap
Casquette adulte
TWILL | 200gr/m²
100% COTTON



90022 58cm 1u. 5
Z90022 50u. 1

Gorra bob
Bob hat
Casquette bob
TWILL | 200gr/m²
100% COTTON



90023 58cm 1u. 5
Z90023 50u. 1



Bolsa eco pequeña

Small eco bag
Petit sac eco

CLOTH | 105gr/m²
100% COTTON



90191 23x26cm 1u. 10
Z90191 50u. 1

Bolsa eco grande

Large eco bag
Grand sac eco

CLOTH | 105gr/m²
100% COTTON



Shopping Bag



90190 38x42cm 1u. 10
Z90190 50u. 1



Mochila

Backpack
Sac à dos

CANVAS | 340gr/m²
100% COTTON



90403 30x34x10cm 1u.. 1

Bolsa isleña

Insulated bag
Sac insulaire

CANVAS | 340gr/m²
100% COTTON



90401 40x38x10cm 1u. 1
Z90401 10u. 1

Bolsa náutica

Beach bag
Sac nautique

CANVAS | 340gr/m²
100% COTTON



92656 60x38cm 1u. 1
Z92656 10u. 1

Bolsa asas madera

Wooden-handled Bag
Sac avec poignées de bois

CANVAS | 340gr/m²
100% COTTON



90402 43x40x18cm 1u.. 1

Bolsa plana

Flat bag
Sac plat

CANVAS | 340gr/m²
100% COTTON



90011 28x30cm 1u. 5
Z90011 20u. 1

Bolsa manualidades

Tool bag
Bourse artisanat

CANVAS | 340gr/m²
100% COTTON



92649 48x30x10cm 1u. 1
Z92649 10u. 1



Salvamanteles oval

Oval place mat
Nappe oval

TWILL | 270gr/m²
65% POLY 35% COTTON



91126 46x30cm 1u. 10
Z91126 50u. 1

Salvamanteles

Place mat
Nappe

TWILL | 270gr/m²
65% POLY 35% COTTON



91125 46x33cm 1u. 10
Z91125 50u. 1

Manopla

Oven glove
Moufle

CLOTH | 105gr/m²
100% COTTON



91165 18x30cm 1u. 51
Z91165 20u.

Babero

Bib
Bavoir

TWILL | 270gr/m²
65% POLY 35% COTTON



90240 24x28cm 1u. 5
Z90240 50u. 1

Delantal cocina

Kitchen apro
Tablier cuisine

TWILL | 270gr/m²
65% POLY 35% COTTON



90176 63x92cm 1u. 1
Z90176 10u. 1

Delantal cocina

Kitchen apro
Tablier cuisine

CLOTH | 105gr/m²
100% COTTON



90185 60x90cm 1u. 1
Z90185 20u. 1

Delantal promo

Promo apro
Tablier promo

TWILL | 270gr/m²
65% POLY 35% COTTON



90181 48x71cm 1u. 1
Z90181 20u. 1

Delantal infantil

Child's apro
Tablier infantile

TWILL | 270gr/m²
65% POLY 35% COTTON



90183 33x48cm 1u. 1
Z90183 50u. 1

Bolsa pan

Bread bag
Sac à pain

TWILL | 200gr/m²
65% POLY 35% COTTON



92400 37x60cm 1u. 1
Z92400 20u. 1

Bolsa merienda

Lunch bag
Sac a goûter

TWILL | 270gr/m²
65% POLY 35% COTTON



92417 25x30cm 1u. 5
Z92417 50u. 1





TEXTIL SEDA · SILK TEXTIL · TEXTIL SOIE

Pañuelos de seda 100% — Pongee 05 · 100% Silk scarves — Pongee 05 · Foulards en soie 100% — Pongee 05

A 1 3



S304
55x55cm



S300
90x90cm



S307
180x45cm

Pañuelos de seda 100% — Pongee 08 · 100% Silk scarves — Pongee 08 · Foulards en soie 100% — Pongee 08

A 1 1



S313
55x55cm



S302
90x90cm



S308
180x45cm

Almohadón seda 100% — Pongee 08
100% silk pillow — Pongee 08
Coussin en soie 100% — Pongee 08



S311
39x39cm

Corbata seda 100% — Pongee 08
100% silk tie — Pongee 08
Cravate en soie 100% — Pongee 08



S310
142x9'5cm



PAPEL MACHÉ

PAPER MACHE

PAPIER MACHÉ

ABECEDARIO Y NÚMEROS · ALPHABET & NUMBERS · ALPHABET ET CHIFFRES

10cm

5

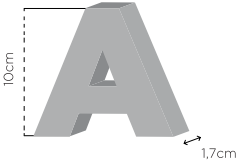

1

set



70150
Set 30 letras
surtidas A-I
3u. x modelo



70151
Set 30 letras
surtidas J-R
3u. x modelo



70152
Set 30 letras
surtidas
S-Z-&-@
3u. x modelo



70153
Set 30 números
surtidos
0-9
3u. x modelo



70155
Set 120 letras, números y
símbolos surtidos. 4 cajas
(70150 + 70151 + 70152 + 70153)



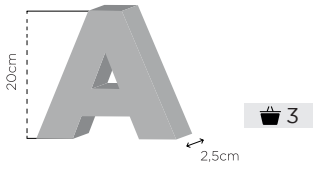

70250
Set 30 letras surtidas A-I
3u. x modelo



70251
Set 30 letras surtidas J-R
3u. x modelo



70252
Set 30 letras surtidas S-Z-&-@
3u. x modelo



70253
Set 30 números surtidos 0-9
3u. x modelo



70255
Set 120 letras, números y
símbolos surtidos. 4 cajas
(70250 + 70251 + 70252 + 70253)

5

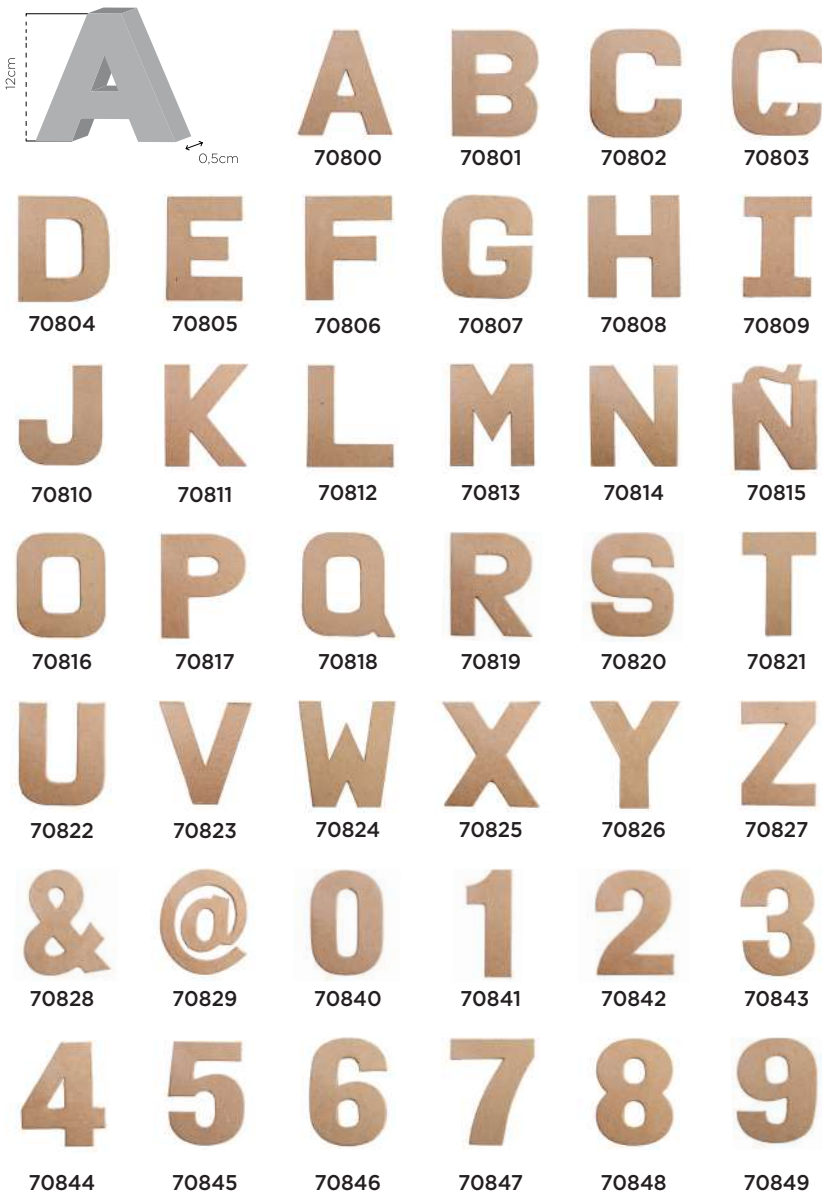

1

set



70850
Set 100 letras surtidas A-I
10u. x modelo



70851
Set 100 letras surtidas J-R
10u. x modelo



70852
Set 100 letras surtidas S-Z-&-@
10u. x modelo



70853
Set 100 números surtidos 0-9
10u. x modelo



70855
Set 400 letras, números y símbolos surtidos. 4 cajas
(70850 + 70851 + 70852 + 70853)





CAJAS CON FORMAS · SHAPED BOXES · BOÎTES AVEC FORMES



PM1051A
8x6,5x4cm
🗑️ 12



PM1052A
10x8x5cm
🗑️ 12



PM1054A
15x12,5x7cm
🗑️ 6



PM1051B
Ø 8x4cm
🗑️ 12



PM1052B
Ø 10x5cm
🗑️ 12



PM1054B
Ø 15x7cm
🗑️ 6



PM1051C
8x4cm
🗑️ 12



PM1052C
10x5cm
🗑️ 12



PM1054C
15x7cm
🗑️ 6



PM1051D
9x7x4cm
🗑️ 12



PM1052D
10x8x5cm
🗑️ 12



PM1054D
15x11x7cm
🗑️ 6



PM1051F
8x6,5x4cm
🗑️ 12



PM1052F
10x8x5cm
🗑️ 12



PM1054F
15x11x7cm
🗑️ 6



PM1051G
8x5x4cm
🗑️ 12



PM1052G
10x6x5cm
🗑️ 12



PM1054G
15x9x7cm
🗑️ 6

🗑️ 12 **+i** Marco fotos
Photo frame
Cadre photo



PM1051AP
8x6,5x4cm



PM1051BP
Ø 8x4cm



PM1051CP
8x4cm



PM1051DP
9x7x4cm



PM1051FP
10x8x5cm

CAJAS CON RELIEVE · RELIEF BOXES · BOÎTES AVEC RELIEF

🗑️ 3



PM6299
16x9x3cm



PM6300
16x7x3cm



PM6301
14x3x3cm



1

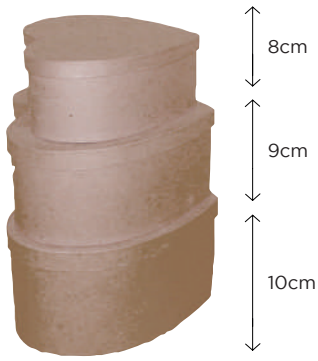

PM1053A
20-22-24cm

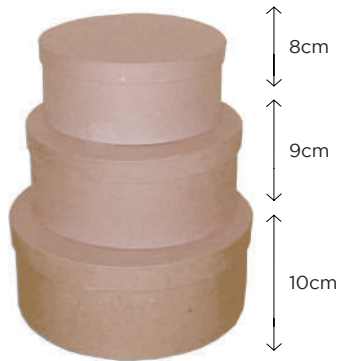

PM1053B
18-21-24cm

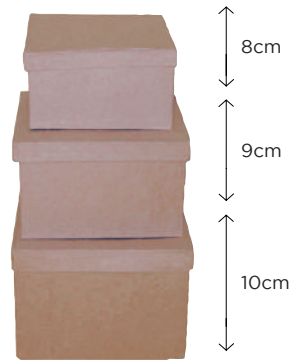

PM1053C
15-19-22cm

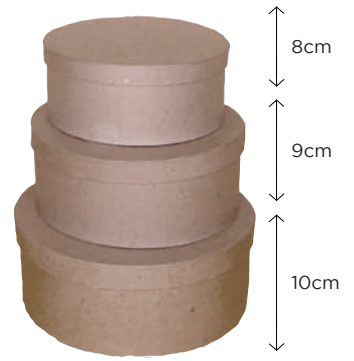

PM1053D
14-22-26cm

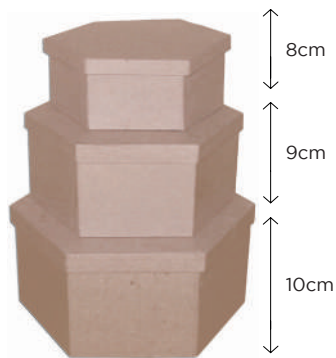

PM1053E
17-19-23cm

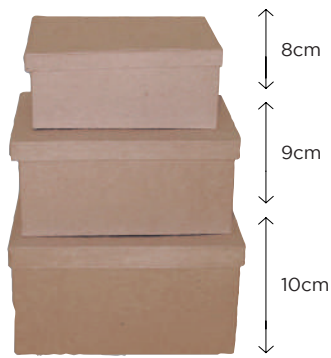

PM1053F
20-23-25cm

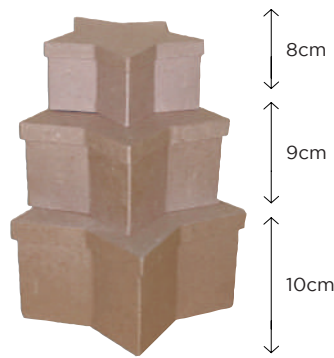

PM1053G
18-23-27cm



PM1053H
18-23-30cm



CAJAS BOLSO · PURSE BOXES · BOURSE BOÎTES

1



PM2083
8cm



PM545B
13cm

BAÚL · TRUNK · COFFRE

1



PM3611
15cm



PM3676C
10x10x30cm



PM3676B
Ø13x30cm



COLGANTES CON FORMAS · SHAPED PENDANTS · PENDANTS AVEC FORMES



PM141
25cm
🛒 1



PM1837
13cm
🛒 12

🛒 1



PM156
60cm



PM158
30cm



PM160
15cm

🛒 1



PM2802 20cm
PM2803 30cm



PM251S
8cm



76336A
35cm



PM519S
20cm
🛒 1



PM519M
25cm
🛒 1



PM519L
30cm
🛒 1





COLGANTES · PENDANTS · PENDENTIFS

9cm

9cm 🛒 12



Marco fotos
Photo frame
Cadre photo



PM5001A



PM5001B



PM5001C



PM5001D



PM5001F



PM5001H



PM5001G



PM5001W

COLGANTES PLANOS · FLAT PENDANTS · PENDENTIFS PLATS

🛒 12



PM6283A
9cm



PM6283B
10cm



PM6283D
13cm



PM6283G
12cm



PM6283J
15cm



PM6283K
12cm

COLGANTES CON VOLUMEN · VOLUME PENDANTS · PENDANTS AVEC VOLUME

🛒 12



PM529
10cm



PM520
Ø6cm



COLGANTES CON RELIEVE · RELIEF PENDANTS · PENDENTIFS AVEC RELIEF

🛒 12



PM9014
5cm



PM9022
7cm



PM9024
10cm



PM9018
10cm



PM9002
10cm



PM9003
10cm



PM9006
10cm



LOVE

I Love You

LIFE

friends

I'M
crazy
FOR YOU



FORMAS DE PLÁSTICO

—
PLASTIC FORMS

—
FORMES EN PLASTIQUE

+i Poliestireno cristal · Polystyrène cristal · Crystal polystyrene



Bola · Ball · Boule



310105	Ø 5cm	18u.
310106	Ø 6cm	15u.
310107	Ø 7cm	12u.
310108	Ø 8cm	8u.
310109	Ø 9cm	5u.
310110	Ø 10cm	5u.
310112	Ø 12cm	5u.
310114	Ø 14cm	4u.
310116	Ø 16cm	4u.

Corazón · Heart · Coeur



310206	6,5x6,5cm	12u.
310208	8x8cm	8u.
310210	10x10cm	6u.

Huevo · Egg · Oeuf



310506	6x4cm	12u.
310508	8x6cm	8u.
310510	10x7cm	6u.
310513	13x9cm	5u.

Huevo · Egg · Oeuf



310512	12x9cm	5u.
---------------	--------	-----

Estrella · Star · Étoile



310408	8x8cm	8u.
310410	10,5x10,5cm	6u.

Estrella · Star · Étoile



310411	10,5x10,5cm	6u.
---------------	-------------	-----

Campana · Bell · Cloche



310610	10x9cm	6u.
---------------	--------	-----

Árbol · Tree · Arbre



310710	10x9cm	6u.
---------------	--------	-----



MAXI PACK FORMAS DE PLÁSTICO

—
PLASTIC FORMS MAXI PACK

—
MAXI PACK FORMES EN PLASTIQUE

Bolas · Balls · Boules



maxi
pack



Ø5cm (18u.) | Ø6cm (15u.) | Ø7cm (12u.) | Ø8cm (8u.) | Ø9cm (5u.) | Ø10cm (5u.)

310801

▲ 63u.

Bola, estrella, campana y árbol · Ball, star, bell and tree · Boule, étoile, cloche et arbre



maxi
pack



Bola Ø6cm (15u.) | Ø8cm (8u.) | Ø10cm (5u.)
Estrella 10,5x10,5cm (6u.) | Campana 10x9cm (6u.) | Árbol 10x9cm (6u.)

310802

▲ 46u.





Bola, corazón y estrella · Ball, heart and star · Boule, coeur et étoile

Huevos · Eggs · Oeufs



Bola Ø8cm (8u.) | Corazón Ø8cm (8u.) | Estrella Ø8cm (8u.)

6x4cm (24u.) | 8x6cm (24u.) | 10x7cm (24u.)

310800

▲ 24u.

310803

▲ 72u.





FORMAS DE PLEXIPLAST

PLEXIPLAST FORMS

FORMES EN PLEXIPLAST



Packaging
Ref.

3

- **Transparencia del 93%. Es el más transparente de los plásticos.**
- **Alta resistencia al impacto, de unas diez o veinte veces superior a la del vidrio.**
- **Muy ligero, con una densidad de 400 a 900kg/m³.**
- **Resistencia al rayado respecto a otros plásticos.**
- **No tóxico y libre de C.F.C.**

- 93% Transparency. These are the most transparent plastic.
- High impact strength, about ten to twenty times stronger than glass.
- Very light, with a density of 400-900 kg/m³.
- Scratch resistance compared to other plastics.
- Non-toxic and free of C.F.C.

- Transparence de 93%. Ce son les plastiques les plus transparentes.
- Résistance aux chocs élevée, de dix à vingt fois plus élevé que celle du verre.
- Léger, avec une densité de 400-900 kg/m³
- Résistance à la rayure par rapport à d'autres plastiques.
- Non toxique et sans C.F.C.

Bola · Ball · Boule



A3425 Ø 16cm



Todos los modelos se componen de 3 piezas: dos tapas y un separador, así podemos conseguir más opciones de decoración.

All models are composed of 3 pieces: two covers and a separator, so that we can get more decorating options

Tous les modèles sont composés de 3 pièces: deux couvertures et d'un séparateur, afin que nous puissions obtenir plus d'options de décoration.

Bombilla · Bulb · Ampoule



A3426 10x4cm
A3427 16x7cm

Corazón · Heart · Coeur



A3431 16x4,5cm

Campana · Bell · Cloche



A3429 16x15cm

Gota · Drop · Goutte



A3432 10x5,5cm

Medalla · Medallion · Médaille



A3434 10x4cm

Lágrima · Tear · Larme



A3436 10x4,5cm
A3437 16x7cm

Estrella · Star · Étoile



A3438 10x5cm
A3439 16x8cm

Huevo · Egg · Oeuf



A3440 6x4cm
A3441 8x5,5cm
A3442 10x6,5cm
A3443 12x8cm
A3444 14x9cm
A3445 16x10,5cm

FORMAS Y FIGURAS DE POLIESTIRENO

POLYSTYRENE FORMS

FORMES DE POLYSTYRÈNE



Packaging A + Ref.

Bolsa
Bag
Sachet



Packaging Z + Ref.

Granel
Vrac
Bulk

LETRAS · LETTERS · LETTRES

alt 7,5cm 10u. A 1 1



Envase Z, más económico, no plastificado. Cajas con código de barras.
Z pack, economical, not shrink-wrapped. Boxes with barcode.
Emballage Z, plus économique, non plastifié. Boîtes avec code-barres.



A3340



A3341



A3342



A3343



A3344



A3345



A3346



A3347



A3348



A3349



A3350



A3351



A3352



A3353



A3354



A3355



A3356



A3357



A3358



A3359



A3360



A3361



A3362



A3363



A3364



A3365

NÚMEROS · NUMBERS · CHIFFRES

alt 7,5cm 10u. A 1 1



A3366



A3367



A3368



A3369



A3370



A3371



A3372



A3373



A3374



A3375



A3376



A3377

SET ABECEDARIO · ALPHABET SET · SET ALPHABET

A3694 alt 7,5cm 1u. A 1 1

set



SET NÚMEROS · NUMBERS SET · SET CHIFFRES

A3695 alt 7,5cm 1u. A 1 1

set





BOLAS · BALLS · BOULES

A 1 5 Z 1 1

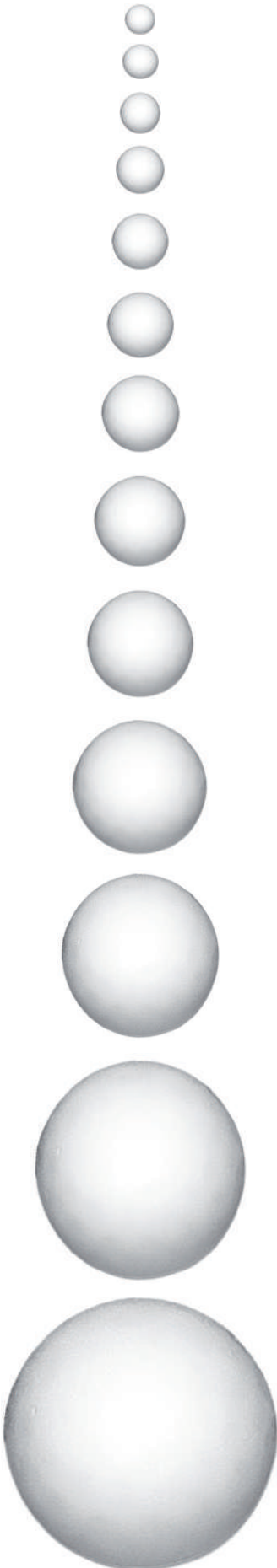

A3499	Ø 2,5cm	50u.
Z3499		2.650u.
A3500	Ø 3cm	50u.
Z3500		1.500u.
A3501	Ø 4cm	25u.
Z3501		650u.
A3502	Ø 4,5cm	20u.
Z3502		500u.
A3503	Ø 5cm	15u.
Z3503		350u.
A3504	Ø 6cm	8u.
Z3504		200u.
A3505	Ø 7cm	5u.
Z3505		125u.
A3506	Ø 8cm	4u.
Z3506		80u.
A3509	Ø 10cm	2u.
Z3509		40u.
Z3510	Ø 12cm	22u.
Z3519	Ø 15cm	24u.
Z3520	Ø 20cm	12u.
Z3521	Ø 30cm	8u.

PEÓN · PAWN · PION

A 1 3



A3645 10cm 10u.

A3646 15cm 2u.

PLANCHA · PLATE · PLAQUE

A 1 1



Plancha · Plate · Plaque - 1cm

A3653	15x20x1cm	5u.
A3654	20x30x1cm	5u.
A3655	30x40x1cm	5u.

Plancha · Plate · Plaque - 2cm

A3656	15x20x2cm	5u.
A3657	20x30x2cm	5u.
A3658	30x40x2cm	5u.

SOMBRERO · HAT · CHAPEAU

A 1 3



A3602
29x10cm



CAJAS · BOXES · BOÎTES

A 1 3

Baúl · Trunk · Coffre



A3610

15,5x11,5x8cm

Caja corazón · Heart box · Boîte coeur



A3611

14x14x8cm

Caja oval · Oval box · Boîte ovale



A3612

15,5x11,5x7cm

Caja cuadrada · Square box · Boîte carré



A3613

13,5x13x9cm

Caja redonda · Round box · Boîte ronde



A3614

∅ 13,5x9cm



FIGURAS GEOMÉTRICAS · GEOMETRIC FORMS · FIGURES GÉOMÉTRIQUES

A 1 3 Z 1 1

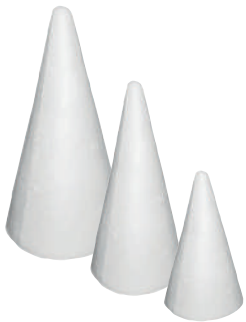

Cono · Cone · Cône



A3650 ∅ 4x6cm 15u.

A3651 ∅ 7x12,5cm 4u.

A3652 ∅ 9x20cm 1u.

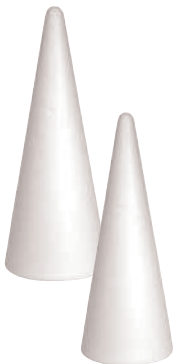

Cono · Cone · Cône



A3295 ∅ 11,5x30cm 1u.

A3296 ∅ 14x37cm 1u.



Cilindro · Cilinder · Cilindre



A3544 ∅ 4x20cm 4u.

A3545 ∅ 7x20cm 2u.



Cono eco · Eco cone · Cône eco



A3574 ∅ 6,5x9cm 4u.

Z3574 150u.

A3575 ∅ 8,5x18cm 1u.

Z3575 40u.

A3576 ∅ 11,5x24cm 1u.

Z3576 18u.



Pirámide · Pyramid · Pyramide



A3315 4x4x6cm 15u.

A3316 9x9x12,5cm 2u.

A3317 12x12x20cm 1u.



CORONA PLANA · FLAT RING · COURONNE PLAT

A



		▲
A3380	∅10cm	10u.
A3381	∅12,5cm	6u.
A3382	∅15cm	4u.
A3383	∅18cm	4u.
A3384	∅20cm	1u.
A3385	∅25cm	1u.
A3386	∅30cm	1u.

CORONA COMPLETA · ROUND-EDGE RING · COURONNE COMPLÈTE



		▲
A3390	∅10cm	6u.
A3391	∅12,5cm	4u.
A3392	∅15cm	2u.
A3393	∅18cm	2u.
A3394	∅22cm	1u.
A3395	∅25cm	1u.
A3396	∅30cm	1u.



MEDALLÓN · MEDALLION · MÉDAILLON



		▲
A3546	∅6cm	25u.
A3404	∅8cm	15u.
A3547	∅10cm	6u.

DISCO · DISK · DISQUE



CAPITEL · CHAPTER · CHAPITEAU



		▲
A3543	∅7x11cm	1u.

		▲
A3290	5x5cm	12u.
A3291	10x5cm	3u.
A3292	15x5cm	1u.
A3293	20x5cm	1u.
A3294	25x5cm	1u.

HUEVO · EGG · OEUF

A 1 5 Z 1 1



A3550	∅ 4x6cm	10u.
Z3550		400u.
A3551	∅ 5,5x8cm	6u.
Z3551		200u.
A3552	∅ 7x10cm	5u.
Z3552		115u.



HUEVO (dos mitades) · EGG (two halves) · OEUF (deux moitiés)

A 1 3



A3553	15,5x11cm	1u.
A3554	22,5x15,5cm	1u.
A3297	20x28cm	1u.
A3298	27x38cm	1u.

CORAZÓN LLENO · FULL HEART · COEUR PLEIN

A 1 3



A3331	5cm	30u.
A3332	7cm	10u.
A3333	11cm	2u.
A3334	15cm	1u.



A3330	4cm	30u.
-------	-----	------

CORAZÓN PLANO · FLAT HEART · COEUR PLAT

A 1 3



A3301	14x5cm	2u.
-------	--------	-----

CORAZÓN PLANO BORDES REDONDEADOS · FLAT HEART ROUNDED EDGE · COEUR PLAT BORDS ARRONDIS

A 1 3



A3300	14x14cm	2u.
-------	---------	-----



CORAZÓN ECO · ECO HEART · COEUR ECO

A 1 3 Z 1 1



A3560	6cm	15u.
Z3560		500u.
A3562	10cm	2u.
Z3562		80u.



MARCO · FRAME · CADRE

A 1 3



- A3302** int. 8x12,5cm 1u.
ext. 21x16,5cm
- A3303** int. 15x8,5cm 1u.
ext. 24x17,5cm
- A3304** int. 21x13,5cm 1u.
ext. 32x24cm

MARCO CON FONDO · FRAME WITH BOTTOM · CADRE AVEC FOND

A 1 3



- A3310** 14,5x13cm 1u.
(para foto 5x4cm)
- A3311** 24x19cm 1u.
(para foto 10x15cm)
- A3312** 27x21cm 1u.
(para foto 13x18cm)

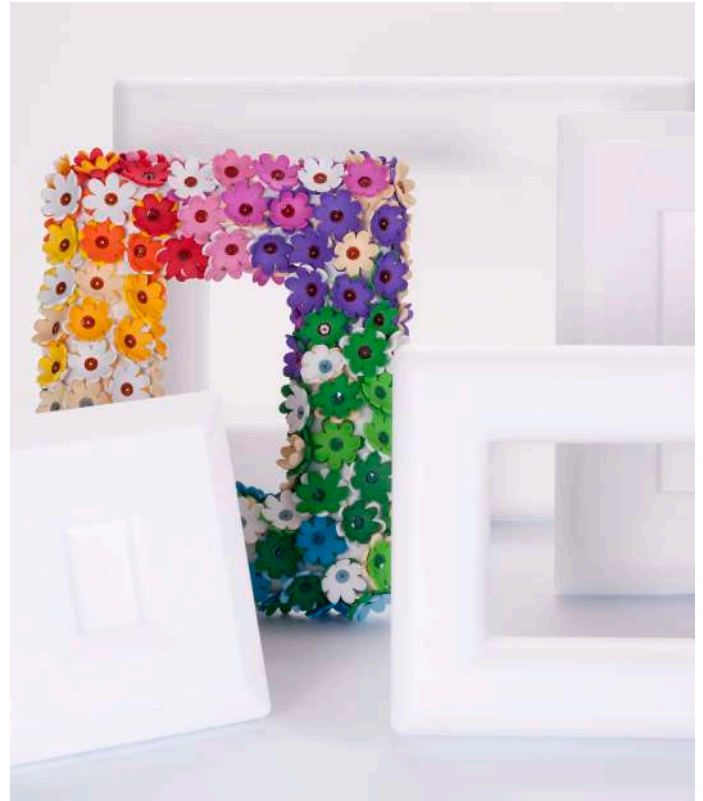

A 1 3

Z 1 1



- A3325** 10cm 15u.
- A3326** 15cm 4u.
- A3327** 20cm 2u.
- A3328** 25cm 1u.



- A3573** 16cm 4u.
- Z3573** 110u.



- A3566** 32cm 1u.



- A3320** 10cm 10u.
- A3321** 13,5cm 6u.
- A3322** 15cm 4u.
- A3323** 20cm 1u.



- A3541** 15cm 5u.
- Z3541** 120u.



- A3542** 32cm 1u.



- A3567** Ø 44cm 1u.



- A3568** Ø 39cm 1u.



- A3569** Ø 26cm 1u.



- A3572** 17cm 2u.
- Z3572** 60u.

COLGANTES NAVIDEÑOS · CHRISTMAS PENDANTS · PENDENTIFS NÖEL

A 1 3

Abeto · Fir tree · Sapir



A3534 10,5x5,5cm 10u.

Abeto · Fir tree · Sapir



A3660 7,5x5,5cm 15u.

Abeto · Fir tree · Sapir



A3539 14x9cm 4u.

Campana · Bell · Cloche



A3535 Ø4,5x6cm 20u.

Ángel · Angel · Ange



A3661 6x9cm 10u.

Ángel · Angel · Ange



A3511 12,5x9cm 5u.

Estrellas · Stars · Étoiles



A3538 8,5cm 10u.

Estrellas · Stars · Étoiles



A3517 7x13cm 15u.

Luna · Moon · Lune



A3662 9x6cm 10u.

Muñeco de nieve · Snowman · Bonhomme de neige



A3537 9,5x6cm 6u.

Copo de nieve · Snowflake · Flocon de neige



A3643 7,5cm 10u.

Corazón · Heart · Coeur



A3536 6,5x5cm 15u.

Ángel · Angel · Ange



A3676 9,5x5cm 10u.

Santa Claus · Santa Claus · Père Noël



A3677 9x4cm 15u.

Santa Claus · Santa Claus · Père Noël



A3686 8x5cm 10u.

Perro · Dog · Chien



A3680 8x5cm 15u.

Casita · Little house · Petite maison



A3681 7x5cm 15u.

Pajarito · Little bird · Petite oiseau



A3684 6,5x10,5cm 10u.

Bola rayada · Striped ball · Boule rayée



A3683 8,5x8cm 4u.

Adorno · Ornament · Ornament



A3687 10x6,5cm 10u.

Oso · Bear · Ours



A3663 8x5,5cm 10u.

Bota · Boot · Botte



A3685 6x6cm 15u.

Farolillo · Lantern · Lanterne



A3678 7x4cm 15u.

Farolillo · Lantern · Lanterne



A3682 6,5x5cm 10u.

Adorno · Ornament · Ornament



A3679 13x5cm 8u.

Bola · Ball · Boule



A3636 Ø8cm 4u.

Bola diamante · Diamond ball · Boule diamant



A3557 Ø8,5cm 2u.





NAVIDEÑOS · CHRISTMAS · NÖEL

A 1 3

Campana · Bell · Cloche



Árbol Navidad · Christmas tree · Arbre de Noël



A3640 16x31,5cm 1u.

Santa Claus · Santa Claus · Père Noël



A3642 21cm 1u.

Ángel · Angel · Ange



A3664 22x15,5cm 1u.

Copo de nieve · Snowflake · Flocon de neige



A3666 17,5x9cm 1u.

Angelus · Angelus · Angelus



A3665 10x20cm 2u.

A3530	Ø 8,5x8cm	2u.
A3531	Ø 9x9,5cm	2u.
A3532	Ø 11x11cm	2u.
A3533	Ø 16x16cm	1u. 5

PESEBRE · NATIVITY SCENE · CRÈCHE

A 1 1

Virgen Maria · Virgin Mary · Vierge Marie



A3668 24x18cm

San José · Saint Joseph · San Jose



A3667 30x30cm

Niño Jesús · Baby Jesus · Enfant Jésus



A3669 17x7,5cm

Buey · Ox · Boeuf



A3670 23x13cm

Asno · Donkey · Baudet



A3671 23x15cm

Pastor y oveja · Shepherd & sheep · Berger et mouton



A3672 30x14cm

Rey Melchor · Melchor King · Roi Melchor



A3673 31x14cm

Rey Baltasar · Baltasar King · Roi Baltasar



A3675 24x14cm

Rey Gaspar · Gaspar King · Roi Gaspar



A3674 31x14cm



ANIMALES · ANIMALS · ANIMALS

A 1 3

Cerdo · Pig · Porc



A3467 11x15cm 1u.

Vaca · Cow · Vache



A3461 14x17cm 1u.

Cabra · Goat · Chèvre



A3408 11x13cm 2u.

Gato · Cat · Chat



A3456 9,5x13,5cm 2u.

Gato · Cat · Chat



A3457 14cm 2u.

Gato · Cat · Chat



A3625 26cm 1u.

Perro · Dog · Chien



A3620 25cm 1u.

Pony · Pony · Poney



A3417 14x15,5cm 2u.

Asno · Donkey · Baudet



A3462 15x13cm 2u.

Conejo · Rabbit · Lapin



A3412 10,5x13,5cm 1u.

Conejo · Rabbit · Lapin



A3621 25cm 1u.

Ratón · Mouse · Rat



A3468 14cm 2u.

Mariposa · Butterfly · Papillon



A3414 11x12,5cm 6u.

Caracol · Snail · Escargot



A3627 21x20cm 1u.

Mariquita · Ladybug · Coccinelle



A3698 6x10cm 2u.

León · Lion · Lion



A3460 16x13,5cm 1u.

Jirafa · Giraffe · Girafe



A3458 9x13cm 2u.

Hipopótamo · Hippo · Hippopotame



A3459 10,5x14,5cm 1u.



A 1 3

Elefante · Elephant · Éléphant



A3454 10,5x14,5cm 1u.

Cebra · Zebra · Zèbre



A3469 11x14cm 2u.

Oso · Bear · Ours



A3629 26cm 1u.

Oso · Bear · Ours



A3630 18cm 1u.

Oso · Bear · Ours



A3463 20cm 1u.

Pajarito · Birdie · Petit oiseau



A3465 9x18cm 1u.

Búho · Owl · Hibou



A3626 15cm 1u.

Oca · Goose · Oie



A3628 21cm 1u.

Tapir · Tapir · Tapir



A3418 27x22cm 1u.

Cocodrilo · Crocodile · Crocodile



A3411 26x9,5cm 2u.

Unicornio · Unicorn · Licorne



A3579 18x12,5cm 2u.



Gallina · Hen · Poule



A3623 14x9cm 2u.

Gallo · Cock · Cog



A3624 20x13,5cm 1u.

Pollito · Chick · Poussin



A3632 6x6cm 10u.

Patito · Duckling · Caneton



A3631 Ø7x6cm 10u.

Pato · Duck · Canard



A3464 16x13cm 1u.

Pato · Duck · Canard



A3410 12x8cm 4u.

Periquito · Parakeet · Perruche



A3452 13x16cm 2u.

Tucán · Toucan · Toucan



A3699 16,5x22cm 1u.

Pez · Fish · Poisson



A3415 11x4cm 6u.

Pez · Fish · Poisson



A3466 15x8cm 1u.

Sapo · Toad · Crapaud



A3633 14cm 1u.

Pingüinos · Penguins · Manchot



A3416 16x14cm 1u.

Tortuga · Tortoise · Tortue



A3419 6x13cm 2u.

Tortuga · Tortoise · Tortue



A3634 24x9cm 1u.

Foca · Seal · Phoque



A3455 17x8cm 2u.

Delfin grande · Large dolphin · Dauphin grand



A3453 24x8cm 1u.

Cisne grande · Large swan · Cygne grand



A3451 17x12cm 1u.

A3397 8x12cm 4u.

Delfin · Dolphin · Dauphin



A3622 17x6cm 2u.





FRUTAS Y VERDURAS · FRUITS AND VEGETABLES · FRUITS ET LÉGUMES

A 1 3

Piña · Pineapple · Ananas



A3473 22x12cm 1u.

Naranja · Orange · Orange



A3474 8x7cm 4u.

Mandarina · Tangerine · Mandarine



A3637 5x6,5cm 8u.

Granada · Pomegranate · Grenade



A3638 8x7,5cm 4u.

Nuez · Walnut · Noyer



A3639 4,5x4cm 15u.

Alcachofa · Artichoke · Artichaut



A3481 14x8cm 2u.

Plátano · Banana · Banane



A3475 18,5x4cm 4u.

Caqui · Kaki · Khaki



A3476 7x7,5cm 4u.

Kiwi · Kiwi · Kiwi



A3477 7x6cm 6u.

Manzana · Apple · Pomme



A3478 8x8cm 4u.

Pera · Pear · Poire



A3479 10x8cm 4u.

Castaña · Chestnut · Châtaigne



A3496 5x5cm 20u.

Pepino · Cucumber · Concombre



A3483 19x4,5cm 4u.

Melocotón · Peach · Pêche



A3480 7x7cm 4u.

Albaricoque · Apricot · Abricot



A3495 6,5x5,5cm 6u.

Higo · Fig · Figue



A3497 6x4,5cm 15u.

Fresa · Strawberry · Fraise



A3498 5,5x4,5cm 15u.

Limón · Lemon · Citron



A3407 7,5x6cm 6u.

Maiz · Corp · Mais



A3489 22x5cm 4u.

Cebolla · Onion · Oignon



A3484 6x7cm 4u.

Hinojo · Fennel · Fenouil



A3485 12x8cm 2u.

Seta · Mushroom · Champignon



A3486 13cm 1u.

Seta · Mushroom · Champignon



A3487 8cm 4u.

Pimiento · Pepper · Poivre



A3491 10x8,5cm 4u.

Berenjena · Eggplant · Aubergine



A3488 19x6cm 3u.

Apio · Celery · Céleri



A3493 19,5x5,5cm 3u.

Zanahoria · Carrot · Carotte



A3482 29,5x5,5cm 2u.

Patata · Potato · Pomme de terre



A3490 10x5cm 4u.

Tomate · Tomato · Tomate



A3492 7x8,5cm 4u.

Calabaza · Pumpkin · Citrouille



A3494 8,5x12,5cm 1u.

Ajo · Garlic · Ail



A3609 6,5x7cm 6u.





VARIOS · VARIOUS · MISCELLANEOUS

A 1 3

Dalia · Dahlia · Dahlia



A3471 13,5cm 4u.

Girasol · Sunflower · Tournesol



A3472 15cm 2u.

Rosa · Rose · Rose



A3513 9cm 6u.

Cinta lazo · Ribbon tie · Cravate ruban



A3555 8x9,5cm 6u.

Coche · Car · Voiture



A3447 17x11cm 1u.

Moto · Motorbike · Moto



A3448 11x7cm 2u.

Locomotora · Locomotive · Locomotive



A3449 7,5x12cm 2u.

Cinta lazo plana · Flat ribbon tie · Cravate ruban plat



A3556 8x9,6cm 10u.

Barco · Boat · Bateau



A3649 14x17cm 1u.

Aeroplano · Airplane · Avion



A3648 15x16cm 2u.

Colgante timón · Rudder pendant · Pendentif gouvernal



A3470 10,5cm 10u.

Faro · Lighthouse · Phare



Abuelita · Granny · Mamie



A3659 21x11,5cm 1u.

Pierrot · Pierrot · Pierrot



A3600 23cm 1u.

Pierrot · Pierrot · Pierrot



A3601 12,5cm 2u.

A3403 30,5x17,5cm 1u.

A 3

Flor de lis plana · Flat fleur de lys · Fleur de lys plat



A3583 8,5x6cm 30u.

Caramelos · Candy · Bonbons



A3401 9x3cm 15u.

Casita · Little house · Petite maison



A3647 19,5x14cm 1u.

Flor de lis · Fleur de lys · Fleur de lys

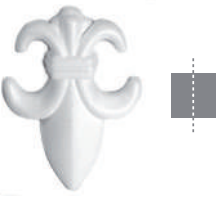

A3584 8,5x6cm 15u.

Hoja · Leaf · Feuille



A3558 8,5x5cm 20u.



MANIQUES · MANNEQUINS · MANNEQUINS

A 1

Cabeza mujer · Women's head · Tête de femme



A3692
29x16cm

Cabeza hombre · Man's head · Tête d'homme



A3693
31x20cm

Mano mujer · Woman's hand · Main de femme



A3697
21cm

Maniquí mujer · Women's mannequin · Mannequin de femme



A3688
72x55cm

Maniquí mujer · Women's mannequin · Mannequin de femme



A3689 35x17,5cm
A3690 25x12cm

Maniquí hombre · Man's mannequin · Mannequin d'homme



A3691
83x60cm



KREUL
seit 1838

innspiro[®]

Distribuye las pinturas y rotuladores de la marca KREUL.

Primera calidad - Made in Germany. La amplia e innovadora gamma le proporcionará el mejor acabado a cualquier proyecto. Marca alemana con una calidad excelente.

Distribute KREUL paints and markers.

Premium quality - Made in Germany. The wide and innovative range will provide the best finish to any project. German brand with excellent quality.

Distribuez les peintures et feutres de la marque KREUL.

Première qualité - Made in Germany. La large et innovatrice gamme vous apportera la meilleure finition à tout projets. Marque allemande avec une excellente qualité.

TODOS LOS PRODUCTOS KREUL EN LA WEB
ALL KREUL PRODUCTS ON THE WEB
TOUS LES PRODUITS KREUL SUR LE SITE



B2B.INNSPIRO.COM



SCAN



+i

Si deseas tener el catálogo en tus manos, solicítalo. O si lo prefieres en formato virtual; escanea el código QR y visualízalo.

If you want to have the catalog in your hands, request it. Or if you prefer it in virtual format; scan the QR code and view it.

Si vous souhaitez obtenir le catalogue, demandez-le-nous. Ou si vous le préférez en virtuel ; scannez le code QR afin de pouvoir le visualiser.

PINTURAS, ROTULADORES Y MEDIOS
PAINTS, MARKERS AND MEANS · PINTURES, FEUTRES ET AUTRE



01

Pintura acrílica
Acrylic paint
Peinture acrylique



02

Pintura para textil y seda
Paint for textile and silk
Peinture pour textile et soie



03

Pintura para cristal y porcelana
Glass and porcelain paint
Peinture pour cristal et porcelaine



04

ACRYLIC - PORCELAIN - GLASS - TEXTIL - PERMANENT
Rotuladores
Markers
Feutres



05

Colas, adhesivos y transfers
Glues, adhesives and transfers
Colles, adhésifs et transferts



06

Pintura para niños
Painting for kids
Peinture pour enfants



PINCELERÍA Ideales para artesanía, acrílica, óleo

PAINTBRUSHES Ideal for crafts, acrylic, oil

PINCEAUX Idéal pour artisans, acrylique, huile

Pinceles sintéticos mango corto

Synthetic paintbrushes, short handle · Pinceaux synthétiques, manche court

Pincel lengua de gato · Oval paintbrush · Pinceau langue de chat

12



GAMA DIS484 1

10 modelos: 24u x medida



31x13,5x24,5cm

Tamaños
Sizes
Tailles

- T484-02
- T484-04
- T484-06
- T484-08
- T484-10
- T484-12
- T484-14
- T484-16
- T484-18
- T484-20

Pincel redondo · Round paintbrush · Pinceau round

12



GAMA DIS485 1

14 modelos: 24u x medida



31x13,5x24,5cm

Tamaños
Sizes
Tailles

- T485-5/0
- T485-000
- T485-00
- T485-0
- T485-02
- T485-04
- T485-06
- T485-08
- T485-10
- T485-12
- T485-14
- T485-16
- T485-18
- T485-20

Pincel plano · Plat paintbrush · Pinceau plat

12



GAMA DIS486 1

11 modelos: 24u x medida



31x13,5x24,5cm

Tamaños
Sizes
Tailles

- T486-0
- T486-02
- T486-04
- T486-06
- T486-08
- T486-10
- T486-12
- T486-14
- T486-16
- T486-18
- T486-20

Pincel pata de cabra · Angled paintbrush · Pinceau patte de chèvre

12



GAMA DIS487 1

7 modelos: 36u x medida



31x13,5x24,5cm

Tamaños
Sizes
Tailles

- T487-08
- T487-10
- T487-12
- T487-14
- T487-16
- T487-18
- T487-20



Pinceles pura cerda mango corto

Bristle Paintbrushes, short handle · Pinceaux pure soie, manche court

Redondo · Rond · Ronde 🗑️ 12



GAMA DIS766 🗑️ 1

9 modelos: 36u x medida



31x13,5x24,5cm

Tamaños
Sizes
Tailles

- W766-0
- W766-02
- W766-04
- W766-06
- W766-08
- W766-10
- W766-12
- W766-14
- W766-16

Plano · Flat · Plat 🗑️ 12



GAMA DIS577 🗑️ 1

9 modelos: 36u x medida



31x13,5x24,5cm

Tamaños
Sizes
Tailles

- W577-0
- W577-02
- W577-04
- W577-06
- W577-08
- W577-10
- W577-12
- W577-14
- W577-16

Pinceles pura cerda plano, mango largo

Flat bristle paintbrushes, long handle · Pinceaux pure soie plat, manche large

Plano · Flat · Plat

🗑️ 12



Tamaños · Sizes · Tailles

- T811-0
- T811-02
- T811-04
- T811-06
- T811-08
- T811-10
- T811-12
- T811-14
- T811-16
- T811-18
- T811-20
- T811-22

Redondo · Rond · Ronde

🗑️ 12



Tamaños · Sizes · Tailles

- T812-02
- T812-04
- T812-06
- T812-08
- T812-10
- T812-12
- T812-14
- T812-16
- T812-18
- T812-20
- T812-22
- T812-24

Pincel cerda especial cola

Bristle brush special for glue

Pinceau en soie spéciaux pour colle



7140

Paletinas pura cerda, mango barnizado

Bristle brushes, varnished handle · Pinceau plat pure soie, manche vernie

🗑️ 12



Tamaños · Sizes · Tailles

- 7130 | 2,5cm
- 7131 | 3,5cm
- 7132 | 4cm
- 7133 | 5cm
- 7134 | 5,5cm
- 7135 | 6,5cm

Paletina pelo de pony

Pony brush · Pinceau plat poney

🗑️ 12



Tamaños · Sizes · Tailles

- 71702 | 2cm
- 71704 | 4cm
- 71706 | 6cm



Pinceles espuma para estarcir · Sponge paintbrushes for stenciling · Pinceaux éponge pour répandre

🛒 12



5100
Ø 2cm

5101
Ø 4cm

Pincel estarcir pura cerda · Stencil bristle paintbrush · Pinceau pour répandre pure soie

🛒 12



T835-0

T835-02

T835-04

Pinceles esponja · Sponge paintbrushes · Pinceaux éponge

🛒 12



512-75 | 75mm

512-50 | 50mm

512-25 | 25mm

3 tallas
3 sizes
3 tailles

set

512-3

25mm | 50mm | 75mm

Rodillo esponja · Foam roller · Rouleau de mousse

🛒 12



T1345 | 19cm

Complementos · Accessories · Compléments

Paletas plástico · Plastic palettes · Paletts matière plastique

🛒 10



W192 | 17,5cm



W182 | 12cm



W199 | 14cm

Difuminos · Shaders · Esfuminos

🛒 12



D811 | 6x135mm

D813 | 10x153mm

D816 | 14x153mm

Limpiapinceles de acero

Steel paintbrush cleaner
Nettoie pinceaux en acier

🛒 1



W1307

Ø 11x22cm



Caballete sobremesa

Table easel
Chevalet tapis de table



690 | 40x12cm

Figuras articuladas · Articulated figures · Figures articulées

Maniquí articulado
Articulated manikin
Mannequin articulé



6000 | 30cm

Maniquí articulado cintura
Articulated waist manikin
Mannequin articulé ceinture



6001 | 30cm

Bastidores con lienzo · Stretches for canvas · Châssis avec toile

Bastidores con lienzo de algodón 100%. Todos los bastidores van montados con clavos y envasados en material termoretráctil para su mayor protección.

Stretchers for 100% cotton canvases. All stretchers are built using nails and packed in shrink wrap to offer the best protection.

Châssis avec toile en coton 100%. Tout les châssis ont un montage avec clous et mis en récipient avec des matières termoretractiles pour avoir une meilleure protection.



Figura · Figure · Figure

F1	6100	22x16 cm
F2	6101	24x19 cm
F3	6102	27x22 cm
F4	6103	33x24 cm
F5	6104	35x27 cm
F6	6105	41x33 cm
F8	6106	46x38 cm
F10	6107	55x46 cm
F12	6108	61x50 cm
F15	6109	65x54 cm
F20	6110	73x60 cm
F25	6111	81x65 cm
F30	6112	92x73 cm
F40	6113	100x81 cm
F50	6114	116x89 cm

Paisaje · Landscape · Paysage

P2	6201	24x16 cm
P3	6202	27x19 cm
P4	6203	33x22 cm
P5	6204	35x24 cm
P6	6205	41x27 cm
P8	6206	46x33 cm
P10	6207	55x38 cm
P12	6208	62x50 cm
P15	6209	65x50 cm
P20	6210	73x54 cm
P25	6211	81x60 cm
P30	6212	92x65 cm
P40	6213	100x73 cm
P50	6214	116x81 cm

Marina · Marine · Marine

M3	6302	27x16 cm
M4	6303	33x19 cm
M5	6304	35x22 cm
M6	6305	41x24 cm
M8	6306	46x27 cm
M10	6307	55x33 cm
M12	6308	63x38 cm
M15	6309	65x46 cm
M20	6310	73x50 cm
M25	6311	81x54 cm
M30	6312	92x60 cm
M40	6313	100x65 cm
M50	6314	116x73 cm

Espátulas · Spatules · Palette knives

🛒 12



- 6401**
17,5x4cm
- 6402**
16,5x3cm
- 6403**
17,5x3cm
- 6404**
18x4cm
- 6405**
17x4cm
- 6406**
19x5cm
- 6407**
18,5x5,5cm
- 6408**
19x6cm
- 6409**
20x7cm
- 6410**
20x7cm
- 6411**
18,5x5cm
- 6412**
20x6,5cm
- 6413**
22x8,5cm
- 6414**
21x8cm
- 6415**
20x6,5cm
- 6416**
21x6,5cm
- 6417**
24x12cm
- 6418**
26x12cm

Paletas madera · Palettess bois · Wood Palettes

🛒 5



Packaging Ref.

Rectangular · Rectangular · Rectangulaire



5312
30x40cm



5313
25x30cm



5314
20x30cm

Oval · Oval · Ovale



5309
30x40cm



5310
25x30cm



5311
20x30cm



Salserillas para paleta · Palette pots · Pots pour palette

Plástico
Plastic
Plastic

🛒 4

Plástico doble
Double plastic
Double plastic

🛒 4

Latón
Brass
Laiton

🛒 2



6330 | 5cm



6331 | 11cm



6332 | 4cm



Herramientas y complementos · Tool and complements · Ébauchoirs

Moldeadores · Shaping tools · Outils pour modeler

21cm 12



6803 6805 6808 6811 6813 6814 6817 6818 6820 6827 6829 6837



set

+i

Con bolsa autocierre
With zipper bag
Avec sachet



refs. 6803-6805-6808-6811-6813-6814

K680-1

6 6



set

+i

Con bolsa autocierre
With zipper bag
Avec sachet



refs. 6817-6818-6820-6827-6829-6837

K680-2

6 6



set

Set cerámica para pastas
Pottery tool set for pastes
Set céramique pour pâtes

+i

Con bolsa autocierre
With zipper bag
Avec sachet



6640

1 8

Vaciadores cerámica · Ceramic gouging tools · Videurs céramique

19cm  12



+i
Con bolsa autocierre
With zipper bag
Avec sachet



K660
 6  6

Retorneadores · Shaping tools · Outils à tournasser

21cm  12



Bruñidores/plegadoras
Burnishers/Folders · Brunissoirs/Pliers

Punta acero
Steel tip
Pointe en acier
 1



65406
16x Ø 0,2cm

Punta de agatha · Agate tip · Pointe d'agate

Punta estrecha
Narrow tip
Pointe étroite
 1



65392
19cm

Punta mediana
Medium tip
Pointe moyen
 1



65393
19cm

Punta ancha
Large tip
Pointe large
 1



65394
19cm

Punzón
Awl
Poinçon
 20



44111
16mm





Abrasivos · Abrasives · Abrasives

Tacos espuma · Sanding block · Taquets mousse

10 10x6,5x2,5cm

Taco grano mediano - 60
Taquet grain moyen
Medium grain block



401

Taco grano fino - 100
Taquet grain fin
Fine grain block



402

Espojas planas · Flat abrasive blocks with sponge-backing · Éponges plates

10 12x10x1,5cm

Taco grano mediano - 60
Taquet grain moyen
Medium grain block



403

Taco grano fino - 100
Taquet grain fin
Fine grain block



404



Ideal para madera, barniz...muy resistentes.

For wood, varnish...Highly resistant.

Idéal pour bois, vernis etc... très résistants.

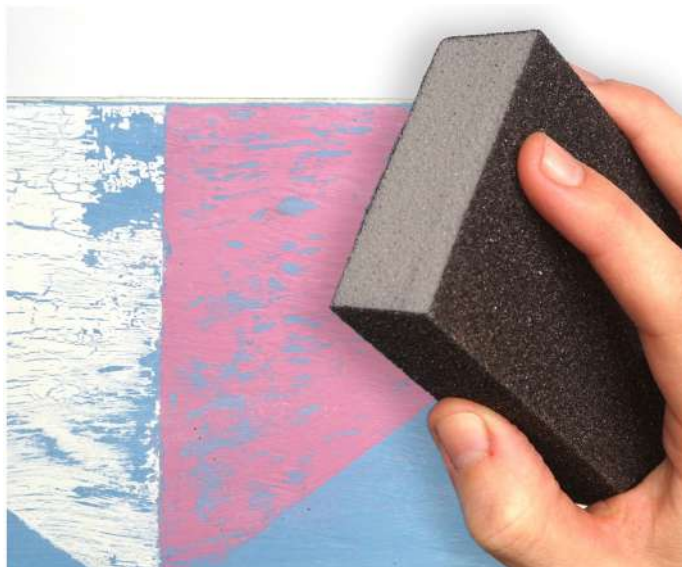

Ideales para superficies difíciles: Molduras...para trabajos en seco o al agua.

For difficult surfaces: frames ... for delicate jobs with wet or dry surfaces.

Idéales pour surfaces difficiles: Moulures...Pour travaux délicats, secs ou à l'eau.



Espojas super flexibles · Extremely flexible abrasive sponges · Éponges super flexibles

10 14x11,5x0,5cm

Grano fino
Fine grain
Grain fin



405

280 microfibra
Microfibrer
Microfibre



406

Hoja de sílex especial madera · Flint leaf for wood · Feuille de sílex spéciale bois

10 28x23cm



Fina - 3/0
Fine
Fin

414

Normal - 4/0

415

Gruesa - 5/0
Thick
Épaisse

416

Hoja de látex (agua) para trabajos en seco o al agua · Latex leaf. For work with wet or dry surface · Feuille de latex. Pour travaux secs ou à l'eau

10 28x23cm



Normal - 150

410

Fina - 320
Fine
Fin

411

Superfina - 1200
Super fine
Extra fin

412



•* CLAYCOLOR® SOFT

PASTA POLIMÉRICA

—
POLYMERIC CLAY

—
PÂTE POLYMÉRIQUE

La pasta claycolor soft se endurece en el horno doméstico a una temperatura de 130°C entre 15 y 20 min. Los tiempos de cocción pueden variar dependiendo del horno que se utilice y de la cantidad de claycolor que se cueza.

La pasta claycolor está pensada para cualquier proyecto de manualidades, tanto para bisutería como para creación de figuras.

Soft claycolor becomes as hard in a domestic oven at 130°C for between 15 and 20 minutes. Baking time can vary depending on the type of oven and the quantity of claycolor that is being baked. Claycolor is suitable for all kinds of handicrafts, both costume jewellery and creating figures.

La pâte claycolor soft se durcit également au four domestique à une température de 130°C entre 15 et 20 minutes.

Les temps de cuisson peuvent varier dépendant du four utilisé et de la quantité de claycolor qui se cuit.

La pâte claycolor est pensée pour tout projet de travaux manuels, aussi bien pour la bijouterie comme pour la création de figures.

24 colores básicos • basic colors • couleurs basics

📦 56gr 🕒 1u 🛒 8



3200
blanco • white • blanc



3201
melocotón • peach
pêche



3202
rosa • pink • rose



3203
fucsia • fuchsia
fuchsia



3204
naranja • orange
orange



3205
rojo • red • rouge



3206
azul claro • light
blue • bleu clair



3207
azul cielo • sky
blue • bleu ciel



3209
turquesa • turquoise
turquoise



3208
azul noche • night blue
bleu nuit



3210
verde primavera • spring
green • vert printemps



3211
verde aguacate
avocado green
vert avocat



3212
amarillo claro • pale
yellow • jaune clair



3213
amarillo • yellow • jaune



3214
ocre • ocher • ocre



3215
terracota • terracotta
terre cuite



3216
marrón oscuro • dark
brown • marron foncé



3217
morado • purple • mauve



3218
vino • wine • vin



3219
beige • beige • beige



3220
café con leche • milky
coffee • cafe au lait



3221
negro • black • noir



3222
gris • grey • gris



3223
dorado • gold • doré

DIS102

47 x 34 x 46cm

24 colores • colors • couleurs:
8u. x color

192 pastillas • tablets
pastilles



🕒 130°C - 15/20min. aprox.

A partir de 8 años.
No usar microondas.
No ingerir ni mezclar con alimentos.
No inhalar los gases.

—
From 8 years old.
Do not heat in the microwave.
Do not swallow or mix with food.
Do not breathe in the fumes.

—
À partir de 8 ans.
Ne pas utiliser le micro ondes.
Ne pas avaler ni mélanger avec les aliments.
Ne pas respirer les gaz.



Paso a paso · Step by step · Pas à pas



1 Laminar el claycolor con la laminadora hasta que esté blanda. Partirlo en dos.

Knead claycolor block with a rolling mill until it's soft. Cut it in half.

Pétrir le Claycolor avec le lamineur jusqu'à ce que la pâte devienne molle. Faire 2 parts.



2 Con la ayuda de un trozo de cadena rolo ref. 80200 hacer la textura.

Add texture to the paste with a help of a piece of rolo chain (ref. 80200).

Avec un morceau de chaîne rolo réf. 80200 faire la texture.

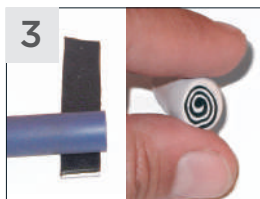

3 Coger 1/4 parte de claycolor blanco y negro y crear el milflores espiral.

Take a quarter of claycolor black and white and create a millefleur spiral.

Prendre de Claycolor blanc et noir et créer la millefleur spirale.

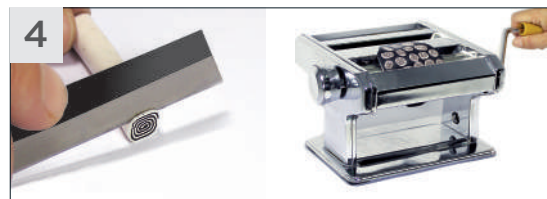

4 Hacer láminas finas de milflores y pegarlas en el trozo de claycolor negro. Laminar para que queden bien adheridas.

Take thin sheets of millefleurs and press them into the black piece of claycolor. Pass the sheet through the rolling mill so that the spirals are pressed in well.

Faire des fines plaques de millefleur et les coller sur le morceau de Claycolor noir. Passer la plaque par le lamineur afin que celles-ci soient bien attachées entre elles.



5 Cortar 3 triángulos negros y 3 con espirales. Cocerlos al horno a 130°C durante unos 15 minutos. Sacar y dejar enfriar.

Cut 3 black triangles and 3 with spirals. Bake it in oven at 130°C for about 15 minutes. Remove and leave to cool.

Couper 3 triangles en noir et 3 en spirales. Faire les cuire à une température de 130°C pendant 15 minutes. Sortir du four et laisser refroidir.

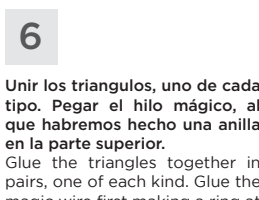

6 Unir los triángulos, uno de cada tipo. Pegar el hilo mágico, al que habremos hecho una anilla en la parte superior.

Glue the triangles together in pairs, one of each kind. Glue the magic wire first making a ring at the top.

Coller les triangles deux par deux de côté, un de chaque modèle. Coller le fil magique sur lequel nous aurons fait un anneau sur la partie supérieure.



Laminadora para pastas · Clay machine · Machine à pâte



+i

Fijador de sobremesa
Table clamp grip
Pièce pour fixer à la table

2506
🛒 1

CREAFIL

Con 19 formas · With 19 shapes · Avec 19 formes



277
🛒 1

Cuchillas acero para pastas con protector
Clay steel blade with safety rubber edge
Couteau flexible avec protecteur

🛒 10



2507
2 x 15,3cm

Set 3 cuchillas con protector
3 blades set with rubber edge for safety
Set 3 couteaux avec protection.

🛒 10



2508

+i

Poner la pasta Claycolor muy blanda dentro del Creafil, esto facilitará su utilización.

Put very soft Claycolor into the Creafil, it makes it very easy to use.

Mettre la pâte Claycolor bien ramollie dans le Créafil, cela facilitera son utilisation.

Cilindro para amasar
Cilindre pour pétrir
Cylinder for kneading

🛒 10



2500
Ø2 x 17,8 cm

Hojas transparentes, opaline
Opaline, transparent leaves
Feuilles transparentes "opaline"

🛒 10



12167

75x52,5cm 🛒 0,50mm

+i

Se usa para hacer plantillas para pintar y al ser rígido y transparente es muy utilizado para hacer plantillas para patchwork.

Used to make stencils for painting. As they are rigid and transparent they are very often used to make stencils for patchwork.

Utilisé pour faire des pochoirs pour peindre étant rigide et transparent il est très utilisé pour faire des pochoirs pour patchwork.





MECANISMOS Y COMPLEMENTOS DE RELOJERÍA

CLOCKWORK MECHANISMS AND ACCESSORIES

MÉCANISME ET COMPLÉMENTS D'HORLOGERIE



Packaging Ref.

5

MECANISMO RELOJ · CLOCKWORK MECHANISM · MÉCANISME HORLOGE

Kit de mecanismo y agujas de plástico. Funciona con 1 pila AA (no incluida).

Mechanism and plastic hands kit. Works with 1 AA battery (not included).

Kit de mécanisme et aiguilles en plastique. Fonctionne avec 1 pile AA (non incluse).



800-12

8mm.

12mm.

Base
5mm.



800-20

8mm.

20mm.

Base
10mm.

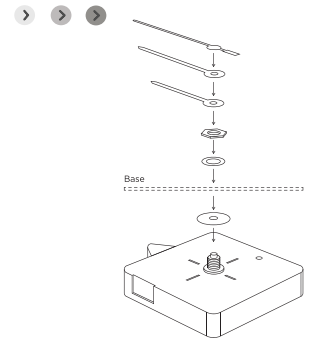



MANECILLAS RELOJ

CLOCK HANDS

AIGUILLES HORLOGE



Packaging Ref.

1
6



Packaging Ref.

25
1

MANECILLAS ALUMINIO · ALUMINIUM HANDS · AIGUILLES ALUMINIUM



Compatible con 800-12 y 800-20
Compatible with 800-12 and 800-20
Compatible avec 800-12 et 800-20



51-35mm



61-45mm



76-52mm



86-60mm

Negro · Black · Noir							
AL9101B	AL9101B-1	AL9642B	AL9642B-1	AL05048B	AL05048B-1	AL9301B	AL9301B-1
1	6	1	6	1	6	1	6
25u.	1u.	25u.	1u.	25u.	1u.	25u.	1u.
Oro · Gold · Or							
AL9101G	AL9101G-1	AL9642G	AL9642G-1	AL05048G	AL05048G-1	AL9301G	AL9301G-1
1	6	1	6	1	6	1	6
25u.	1u.	25u.	1u.	25u.	1u.	25u.	1u.
Plata · Silver · Argent							
AL9101S	AL9101S-1	AL9642S	AL9642S-1	AL05048S	AL05048S-1	AL9301S	AL9301S-1
1	6	1	6	1	6	1	6
25u.	1u.	25u.	1u.	25u.	1u.	25u.	1u.





77-52mm

Negro · Black · Noir	
P201B	P201B-1
☰ 1	6
☰ 25u.	1u.

Blanco · White · Blanc	
P201W	P201W-1
☰ 1	6
☰ 25u.	1u.



93-67mm

Negro · Black · Noir	
P216B	P216B-1
☰ 1	6
☰ 25u.	1u.

Blanco · White · Blanc	
P216W	P216W-1
☰ 1	6
☰ 25u.	1u.

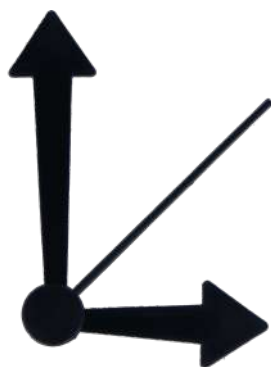

70-50mm

Negro · Black · Noir	
P24B	P24B-1
☰ 1	6
☰ 25u.	1u.

Blanco · White · Blanc	
P24W	P24W-1
☰ 1	6
☰ 25u.	1u.



58-45mm

Negro · Black · Noir	
P34B	P34B-1
☰ 1	6
☰ 25u.	1u.

Blanco · White · Blanc	
P34W	P34W-1
☰ 1	6
☰ 25u.	1u.





COMPLEMENTOS RELOJERÍA

CLOCK ACCESSORIES

COMPLÉMENTS HORLOGE



Packaging Ref.

1

NÚMEROS ROMANOS PLÁSTICO · PLASTIC ROMAN NUMBERS · NUMÉROS ROMAINS PLASTIQUE



1



RN10B
10mm.

RN15B
15mm.



RN10G
10mm.

RN15G
15mm.



RN10S
10mm.

RN15S
15mm.

NÚMEROS ARÁBIGOS PLÁSTICO · PLASTIC ARABIC NUMBERS · NUMÉROS ARABES PLASTIQUE



1



AN10B
10mm.

AN15B
15mm.

AN25B
25mm.



AN10G
10mm.

AN15G
15mm.

AN25G
25mm.



AN10S
10mm.

AN15S
15mm.

AN25S
25mm.





FIELTRO DE LANA

—
WOOL FELT

—
FEUTRE DE LAINE

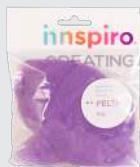

Packaging
A + Ref.

Bolsa

Bag

Sachet

⚖️ 10gr

🗑️ 10



Packaging
Ref.

Caja

Box

Boîte

⚖️ 100gr

🗑️ 1



Packaging
Z + Ref.

Bolsa

Bag

Sachet

⚖️ 1000gr

🗑️ 1

FELTHU son hebras 100% naturales de lana, peinada pero no tensada. A partir de las técnicas adecuadas podemos convertirla en fieltro (un tejido sólido).

Las dos técnicas utilizadas son:

- Técnica con aguja
- Técnica con agua y jabón

Éstas dos técnicas le permiten crear, imaginar, disfrutar y obtener unos resultados sorprendentes.

FELTHU is made from 100% wool fibres, the wool having been carded but not pulled tight. Using the correct techniques, we can convert it into wool felt, a solid material. The two techniques are:

- Technique using a needle
- Technique using soapy water

These two techniques make it possible to create, imagine, enjoy and obtain some surprising results.

FELTHU: ce sont des brins 100% naturels de laine peignée et non tendue. Avec les techniques appropriées, nous pouvons convertir cette laine en feutre de laine (un tissu solide).

Les deux techniques utilisées sont :

- Technique avec aiguille.
- Technique avec eau et savon.

Ces deux techniques vous permettent de créer, imaginer, passer de bons moments et obtenir des résultats surprenants.

CARTA COLORES · COLOUR CHART · CARTE DE COULEURS



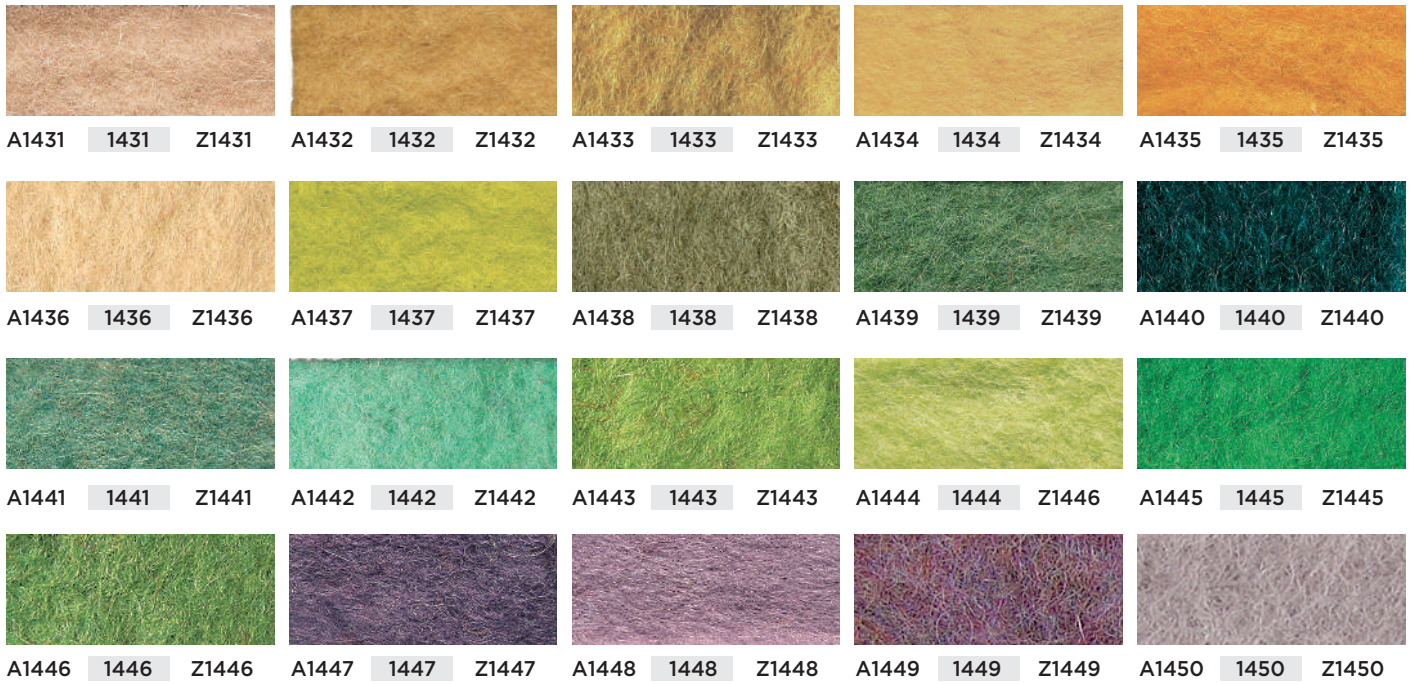

EXPOSITORES bolsas 10gr · DISPLAY bags 10gr · PRÉSENTOIRS sachets 10gr

45u
x9 colors

Gama Básics · Basic Range · Gamme Basics



A1401	5
A1402	5
A1403	5
A1410	5
A1417	5
A1424	5
A1428	5
A1437	5
A1450	5

DIS103

Gama Rojos · Red Range · Gamme Rouge



A1414	5
A1415	5
A1416	5
A1417	5
A1419	5
A1420	5
A1422	5
A1423	5
A1425	5

DIS104

Gama Azules · Blue Range · Gamme Bleu



A1405	5
A1406	5
A1407	5
A1408	5
A1409	5
A1410	5
A1411	5
A1412	5
A1413	5

DIS105

Gama Verdes · Green Range · Gamme Vert



A1437	5
A1438	5
A1439	5
A1440	5
A1441	5
A1442	5
A1444	5
A1445	5
A1446	5

DIS106

Gama Ocre · Ocre Range · Gamme Ocre



A1428	5
A1429	5
A1430	5
A1431	5
A1432	5
A1433	5
A1434	5
A1435	5
A1436	5

DIS107

Carta de colores · Colour chart · Carte de couleurs





DIS70



Agujas enfieltrar
Felting needles
Aiguilles à feutrer



1470	90cm	4u.	5
Z1470		25u.	1

Espuma para enfieltrar
Foam work surface for needle felting
Plaque de mousse pour le feutrage



1480	10x15x4cm	5	
1481	15x20x4cm	5	
1482	20x30x4cm	5	

Microtijeras
Micro-scissors
Micro ciseau



65388	9cm		12
--------------	-----	--	----

Mango para 1 aguja enfieltrar
Felting needle holder for 1 needle
Manche 1 aiguille à feutrer

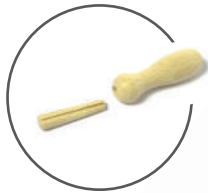

1474	65xØ1,5cm	2u.	5
Z1474		25u.	1

Mango para 4 agujas enfieltrar
Felting needle holder for 4 needle
Manche 4 aiguilles à feutrer



1475	65xØ1,5cm	2u.	5
Z1475		25u.	1

+i
Agujas no incluidas
Needles not included
Aiguille non inclu

+i
Agujas no incluidas
Needles not included
Aiguille non inclu



Trabajamos sobre la esponja
We'll work on the sponge
Nous allons travailler sur l'éponge



Pincharemos para dar forma
We will click to shape
Nous cliquerons pour façonner

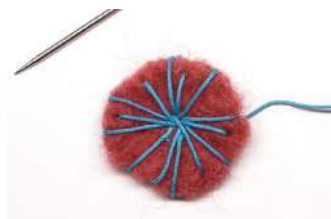

Embelliremos cosiendo
We will beautify by sewing
Nous allons embellir en cousant



Añadiremos otro color
We'll add another color
Nous allons ajouter une autre couleur



Daremos volumen añadiendo fieltro
We will give volume by adding felt
Nous donnerons du volume en ajoutant du feutre



Podemos pulir con tijera
We can polish with scissors
On peut polir avec des ciseaux





Jabón
Soap
Savon



1460
150gr
🛒 5

Malla
Netting
Maille



1461
150x100cm
🛒 5

Cilindro para batanear
Cylinder for pressing
Cylindre pour malaxer



2501
Ø3x40cm
🛒 5

Esterilla
Small matt
Natte



1465 30x45cm 6
1466 80x80cm 1

Bobina burbuja
Roll of bubble wrap
Bobine bulle



320
0,40x150m
🛒 1



Mojar el fieltro con agua caliente
Wet the felt with hot water
Mouiller le feutre avec de l'eau chaude



Aplicar jabón
Apply soap
Appliquer le savon



Amasar dando forma
Kneading into shape
Pétrir pour donner forme



Repetimos la acción hasta que la forma nos quede compacta y dura
We repeat the action until the shape is compact and hard
Nous répétons l'action jusqu'à ce que la forme soit compacte et dure



