

Máquinas & troqueles
Machines & dies
Machines & matrices
de découpe

Zag
Zug
Push



misskuty[®]
by inspiro



misskuty.

MÁQUINAS Y TROQUELES

—
MACHINES AND DIES

—
MACHINES & MATRICES DE DÉCOUPE

A las máquinas MISSKUTY son ligeras y versátiles, fáciles de utilizar, almacenar y transportar. Junto con los troqueles Zag i Zug o las carpetas Push, podrás cortar y repujar una gran variedad de materiales.

—
MISSKUTY machines are light and versatile, easy to use, store and transport. Together with Zag and Zug dies or Push Folders, you can cut and emboss a wide variety of materials.

—
Les machines MISSKUTY sont légères et polyvalentes, faciles à utiliser, à stocker et à transporter. Avec les matrices Zag et Zug ou les dossier de gaufrage, vous pouvez découper et gaufrer une grande variété de matériaux.



MÁQUINAS MISSKUTY · MACHINES MISSKUTY · MACHINES MISSKUTY



41040-M



41040-L

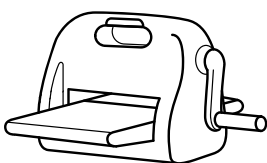

15cm

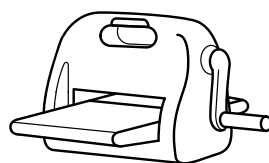

22,5cm



Contiene una máquina MISSKUTY, una plataforma, una base de corte, un adaptador para troqueles gruesos e instrucciones de uso.

—
It includes an MISSKUTY, a Platform, a Cutting Plate, an Adapter for Thick Dies and Instruction Brochure.

—
Contient une machine MISSKUTY, une plateforme, une base de découpe, un adaptateur pour matrices de découpe épaisses et instructions d'utilisation.



Botón micro ajuste
Ajusta la presión entre los dos rodillos y consigue los mejores resultados. ¡Sin necesidad de accesorios adicionales!

Micro-adjustment Switch
It adjusts the pressure of the two rollers to get the best results.
No need of additional accessories!

Bouton micro ajustement
Ajuste la pression entre les deux rouleaux et réussit les meilleurs résultats.
Aucun besoin d'accessoires supplémentaires !

Botón funciones
Escoge una función girando el botón. ¿Te apetece troquelar, repujar en 2D o repujar en 3D?

Function Switch
Select a function by turning the switch. Do you feel like cutting, 2D embossing or 3D embossing?

Bouton fonctions
Choisissez une fonction en tournant le bouton.
Vous avez envie de perforer, gaufrer en 2D ou gaufrer en 3D ?

Plataforma abatible
Al abrir la plataforma, la máquina se adhiere a la superficie gracias a las ventosas situadas en la base. Utiliza el compartimento para almacenar la manivela y pequeños accesorios.

Fold-out Platform
Once the platform is open, the machine adheres firmly to any sturdy and flat surface thanks to suction cups placed on the base. Use the compartment to store the crank handle and small accessories.

Plateforme abattable
En ouvrant la plateforme, la machine s'adhere à la surface grâce aux ventouses situées à la base. Utilisez le compartiment pour emmagasiner la manivelle et les petits accessoires.



INSTRUCCIONES DE FUNCIONAMIENTO

— OPERATING INSTRUCTIONS

— INSTRUCTIONS FONCTIONNEMENT

FOLLETO
— FLYER
— PROSPECTUS



MK002-ES

MK002-FR

Fabricados en acero altamente resistente, permiten cortar papel, cartulina, goma eva y hojas de aluminio.

*También compatibles con máquinas para troquelar de otras marcas.

Made of high resistant steel, they are suitable to cut paper, cards-stock, Eva foam and aluminium sheets.

*Compatible with MISSKUTY Cutting & Embossing Machines and die cutting machines from other brands.

Fabriquées en acier hautement résistantes, elles nous permettent pouvoir couper du papier, bristol, mousse eva et feuilles d'aluminium.

*Compatibles avec les machines pour perforer et gaufrier MISSKUTY et autres marques.

Zag



Troquel fino
Thin Die
Matrice de découpe fine

3

* **Medida de uno de los diseños del troquel** · Measurement of one of the die designs · Mesure de l'un des modèles de matrice

● **Medida del montaje** · Assembly measurement · Mesure du montage

FORMAS GEOMÉTRICAS · GEOMETRIC FORMS · FORMES GÉOMÉTRIQUES

3



4u.

41010

45x45mm - 78x78mm

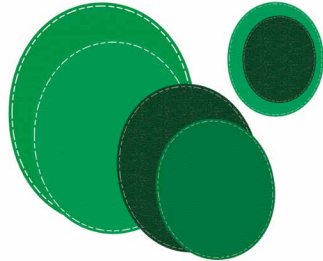

6u.

41011

18x30mm - 62x73mm



7u.

41012

22x22mm - 74x74mm

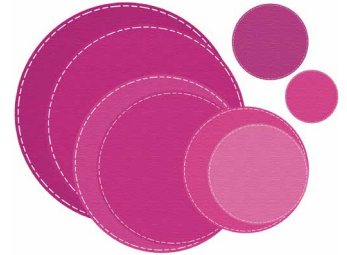

8u.

41013

17mm - 74mm

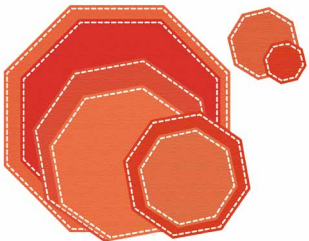

8u.

41183

18x18mm - 86x86mm



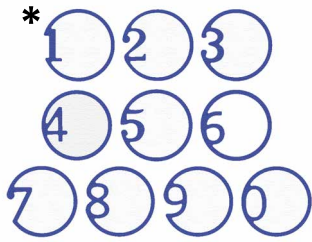

41152

* 26mm



3

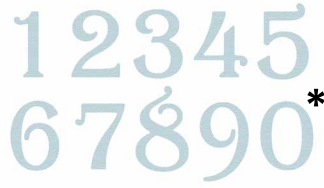

41154

* 19x29mm



3



41156

* 44x47mm



1

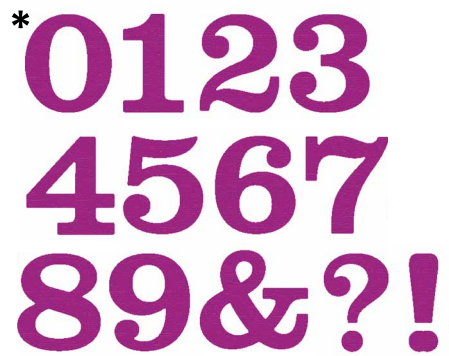

41158

* 41x47mm



1



41153

* 18x21mm



1



41155

* 32x28mm



1



41157

* 26x29mm



1



41160

* 35x53mm



1



41159

* 41x37mm



1

* Medida de uno de los diseños del troquel · Measurement of one of the die designs · Mesure de l'un des modèles de matrice

3

<p>86mm</p>  <p>82mm</p> <p>41136</p>	<p>103mm</p>  <p>42mm</p> <p>41137</p>	<p>90mm</p>  <p>97mm</p> <p>9u.</p> <p>41138</p> <p>* 27x23mm</p> <p>85mm</p>	<p>85mm</p>  <p>127mm</p> <p>3u.</p> <p>41139</p> <p>* 85x82mm</p> <p>75mm</p>
<p>124mm</p>  <p>137mm</p> <p>7u.</p> <p>41140</p> <p>* 45x60mm</p> <p>75mm</p>	<p>124mm</p>  <p>120mm</p> <p>4u.</p> <p>41141</p> <p>* 57x67mm</p> <p>65mm</p>	<p>100mm</p>  <p>75mm</p> <p>5u.</p> <p>41142</p> <p>60mm</p>	<p>75mm</p>  <p>5u.</p> <p>41143</p> <p>67mm</p>
<p>75mm</p>  <p>2u.</p> <p>41144</p> <p>65mm</p>	<p>90mm</p>  <p>4u.</p> <p>41145</p> <p>* 27x50mm</p> <p>48mm</p>	<p>69mm</p>  <p>2u.</p> <p>41146</p> <p>65mm</p>	<p>80mm</p>  <p>2u.</p> <p>41147</p> <p>55mm</p>
<p>73mm</p>  <p>2u.</p> <p>41148</p> <p>75mm</p>	<p>75mm</p>  <p>2u.</p> <p>41149</p> <p>80mm</p>	<p>80mm</p>  <p>2u.</p> <p>41150</p> <p>75mm</p>	<p>75mm</p>  <p>2u.</p> <p>41151</p>

* Medida de uno de los diseños del troquel · Measurement of one of the die designs · Mesure de l'un des modèles de matrice



CUMPLEAÑOS · BIRTHDAY · ANNIVERSAIRE

3

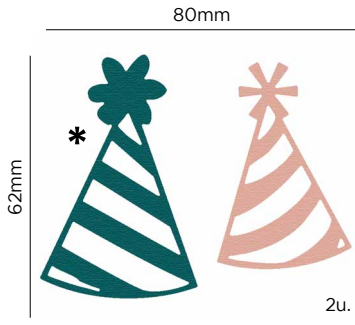

41103

* 42x65mm

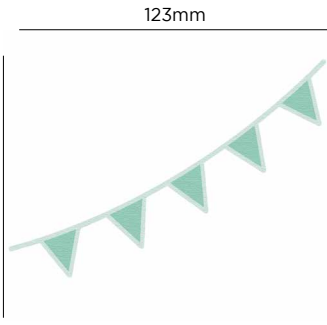

41104

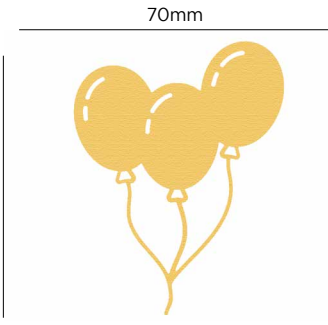

41105

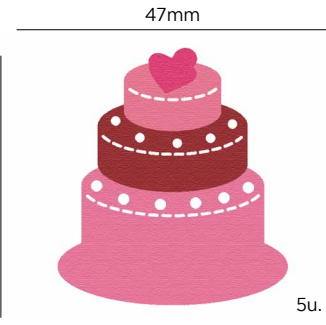

41106

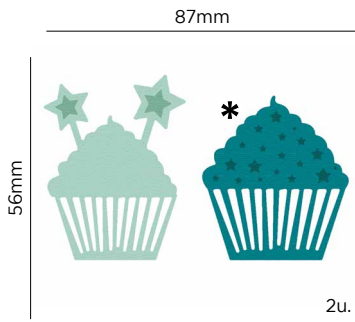

41107

* 42x49mm



41108

VÍDEO PRESENTACIÓN
—
VIDEO PRESENTATION
—
PRÉSENTATION VIDÉO



* Medida de uno de los diseños del troquel · Measurement of one of the die designs · Mesure de l'un des modèles de matrice

<p>113mm</p> <p>105mm</p> <p>65mm</p> <p>4u.</p> <p>41116</p> <p>* 90x39mm</p>	<p>35mm</p> <p>190mm</p> <p>65mm</p> <p>41117</p>	<p>190mm</p> <p>190mm</p> <p>8u.</p> <p>41118</p> <p>* 80x80mm</p>	<p>95mm</p> <p>95mm</p> <p>41119</p>
<p>103mm</p> <p>103mm</p> <p>3u.</p> <p>41120</p>	<p>90mm</p> <p>93mm</p> <p>41121</p>	<p>200mm</p> <p>230mm</p> <p>11u.</p> <p>41122</p> <p>* 42x82mm</p>	<p>116mm</p> <p>112mm</p> <p>41123</p> <p>● 50x50x30mm</p>
<p>72mm</p> <p>78mm</p> <p>41124</p> <p>● 30x30x15mm</p>	<p>50mm</p> <p>50mm</p> <p>6u.</p> <p>41125</p>	<p>92mm</p> <p>92mm</p> <p>11u.</p> <p>41126</p> <p>* 28x36mm</p>	<p>80mm</p> <p>80mm</p> <p>4u.</p> <p>41127</p>
<p>78mm</p> <p>120mm</p> <p>41181</p>	<p>87mm</p> <p>63mm</p> <p>2u.</p> <p>41185</p> <p>* 53x62mm</p>		

* Medida de uno de los diseños del troquel · Measurement of one of the die designs · Mesure de l'un des modèles de matrice

● Medida del montaje · Assembly measurement · Mesure du montage



VERANO · SUMMER · ÉTÉ

3

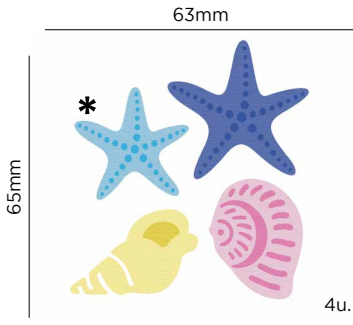

41109

* 31x31mm

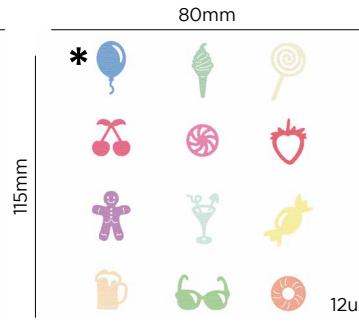

41110

* 17x30mm

1

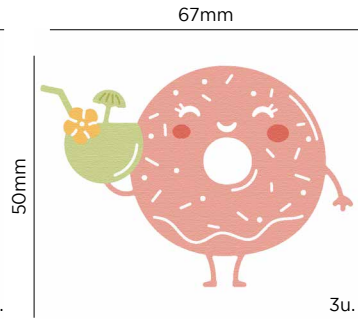

41111

3u.

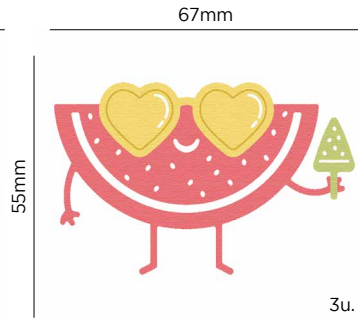

41112

3u.

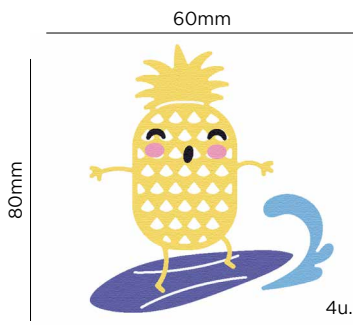

41113

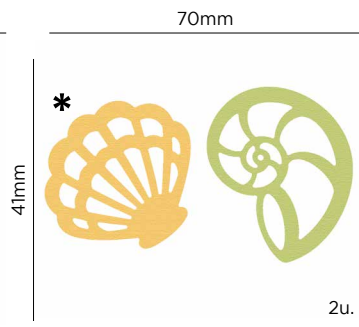

41114

* 37x35mm

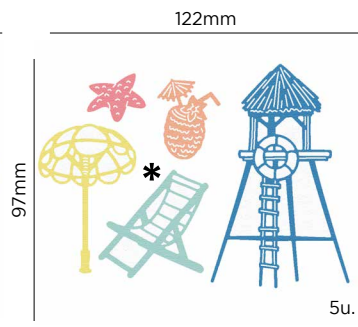

41115

* 43x65mm



HALLOWEEN

3

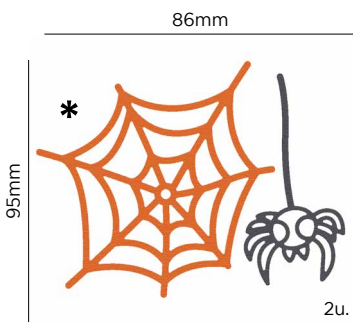

41128

* 70x96mm

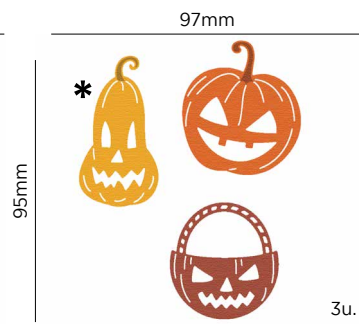

41129

* 32x60mm

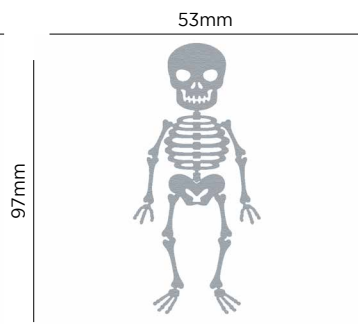

41130

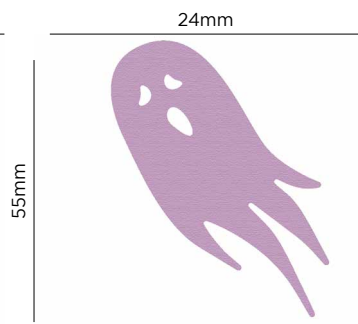

41131

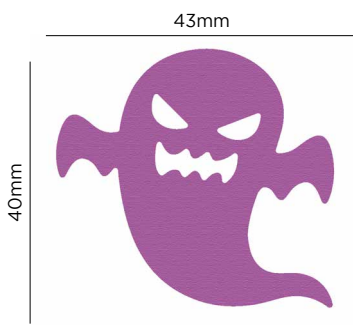

41132

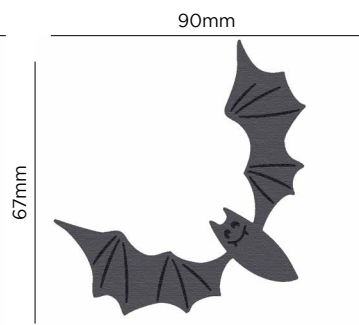

41133

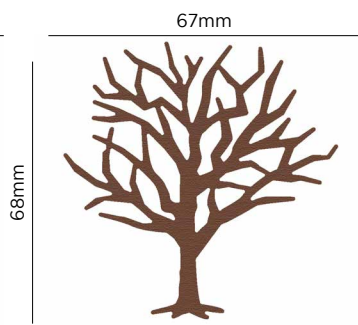

41134

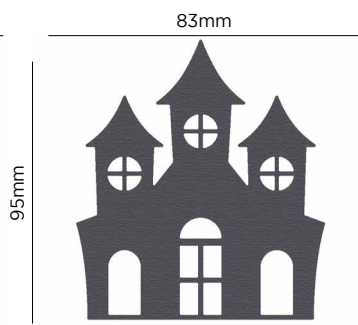

41135

* Medida de uno de los diseños del troquel · Measurement of one of the die designs · Mesure de l'un des modèles de matrice



<p>55mm</p> <p>55mm</p> <p>41161</p>	<p>120mm</p> <p>83mm</p> <p>3u.</p> <p>41162 * 53x83mm</p>	<p>93mm</p> <p>70mm</p> <p>3u.</p> <p>41163 * 47x70mm</p>	<p>82mm</p> <p>75mm</p> <p>3u.</p> <p>41164 * 43x75mm</p>
<p>60mm</p> <p>60mm</p> <p>41165</p>	<p>50mm</p> <p>60mm</p> <p>41166</p>	<p>174mm</p> <p>164mm</p> <p>10u.</p> <p>41167 * 45x50mm</p>	<p>93mm</p> <p>87mm</p> <p>3u.</p> <p>41168 * 45x50mm</p>
<p>35mm</p> <p>60mm</p> <p>41169</p>	<p>55mm</p> <p>45mm</p> <p>41170</p>	<p>67mm</p> <p>70mm</p> <p>41171</p>	<p>50mm</p> <p>40mm</p> <p>41172</p>
<p>35mm</p> <p>37mm</p> <p>41173</p>	<p>117mm</p> <p>120mm</p> <p>4u.</p> <p>41174 * 70x30mm</p>	<p>42mm</p> <p>45mm</p> <p>41175</p>	<p>105mm</p> <p>105mm</p> <p>3u.</p> <p>41014 38mm - 105mm</p>

* Medida de uno de los diseños del troquel · Measurement of one of the die designs · Mesure de l'un des modèles de matrice



3D



41100

● 40x40x60mm  1



41101

● 45x45x90mm  1



41102

● 45x45x93mm  3

● Medida del montaje · Assembly measurement · Mesure du montage

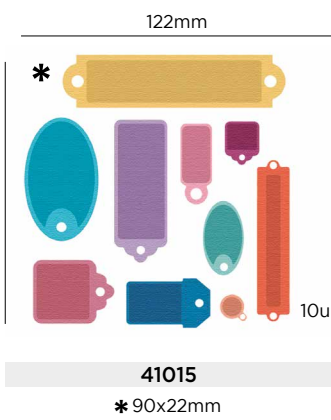
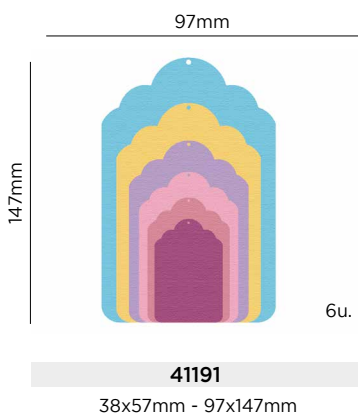
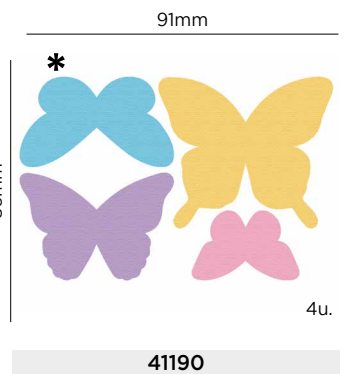
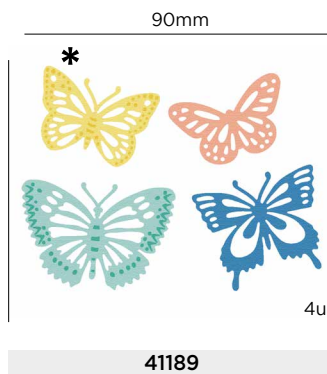
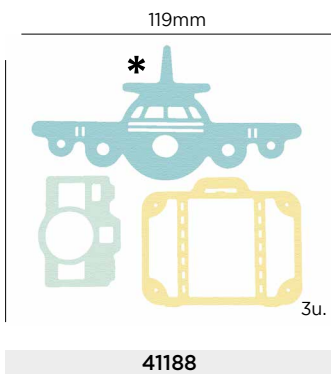
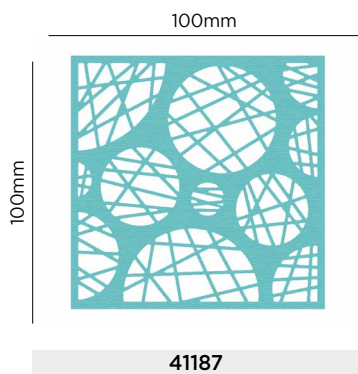
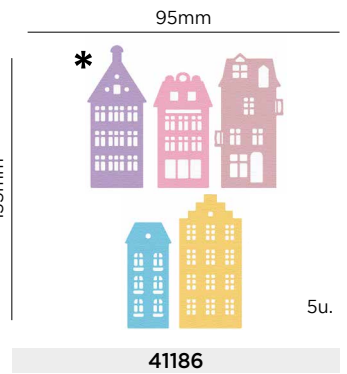
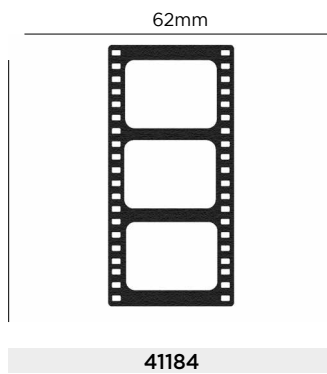
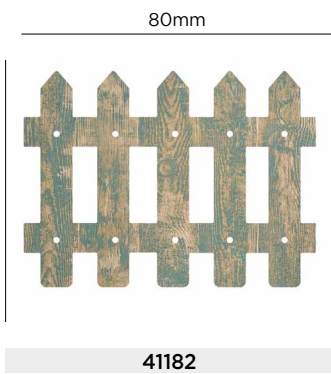
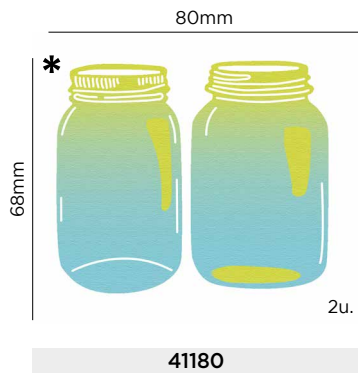
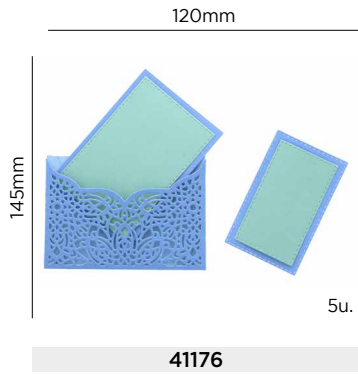



Zug

Los troqueles ZUG son cuchillas de acero integradas en planchas de 1,6cm de grosor. Permiten cortar una gran variedad de materiales de hasta 4mm de grosor: papel, cartulina, goma eva, cuero, fieltro, imán, corcho, madera de balsa, tela y más.

*También compatibles con máquinas para troquelar de otras marcas.

ZUG dies are steel blades built into 1.6 cm thick plates. They are suitable to cut a large variety of materials up to 4 mm thickness: paper, cardstock, Eva foam, leather, felt, magnetic plates, cork, balsa wood, fabric and more.

*Compatible with MISSKUTY Cutting & Embossing Machines and die cutting machines from other brands.

Les matrices de découpe ZUG sont des lames en acier intégrées en planches de 1,6cm d'épaisseur. Elles permettent de couper une grande variété de matériaux jusqu'à 4mm d'épaisseur : papier, bristol, gomme eva, cuir, feutre, aimant, liège, bois de radeau, tissu et plus.

*Compatibles avec les machines pour découper et gaufrer MISSKUTY et autres marques.



Troquel grueso
Thick Die
Matrice de découpe épaisse

1
14x15,2cm.



1



2



3

Adaptador
Adapter
Adaptateur

Troquel grueso
Thick Die
Matrice decoupe épaisse

Papel
Paper
Papier

Base de corte
Cutting Mat
Base de découpe

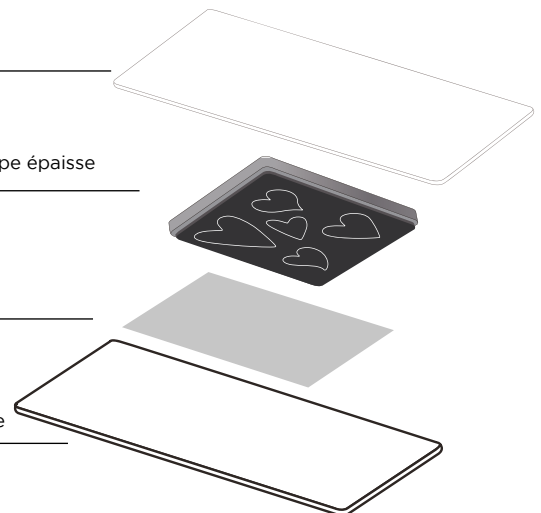

Las bases para las máquinas MISSKUTY se utilizan junto con los troqueles finos ZAG, los troqueles gruesos ZUG, las carpetas de repujado PUSH, placas tipográficas y troqueles y placas textura de otras marcas. Están fabricadas en PVC de alta calidad y, a diferencia de otras marcas, se utiliza con las MISSKUTY tanto para los troqueles finos, como los troqueles gruesos y las carpetas de repujado. La alfombrilla de silicona se utiliza junto con los troqueles finos ZUG aptos para repujar o placas textura para conseguir efecto relieve.

Cutting Mats for MISSKUTY machines are used with ZAG Thin Dies, ZUG Thick Dies, PUSH Embossing Folders, Letterpress Plates and dies and texture plates from other brands. They are made of high quality PVC and, unlike other brands; they are used with MISSKUTY machines for thin dies, thick dies and embossing folders. Silicone Rubber Pad is used with the ZAG Thin Dies which are suitable for embossing or texture plates to get relief effect.

Les bases pour les machines MISSKUTY sont utilisées avec les matrices de découpe fines ZAG, les matrices de découpe épaisses ZUG, les dossiers de gaufrage PUSH, plaques typographiques et matrices de découpe et plaques de texture d'autres marques. Elles sont fabriquées en PVC haute qualité, et à différence d'autres marques, elles sont utilisées avec les MISSKUTY aussi bien pour les matrices de découpe fines, comme pour les matrices de découpe épaisses et les dossiers de gaufrage. Le petit tapis en silicone s'utilise avec les matrices de découpe fines ZAG aptes pour gaufrer ou plaques de texture pour réussir un effet relief.



Base de corte
Cutting mat
Base de découpe



41007

Base de corte
Cutting Mat
Base de découpe
15x33x0,3cm.



41008

Base de corte
Cutting Mat
Base de découpe
22,5x33,0,3cm.



41050

Base de corte transparente
Transparent cutting mat
Base de découpe transparent
15x22x0,3cm.

Plataforma
Platform
Plate-forme

Troquel fino
ZAG Thin Die
Matrice de découpe fine

Papel
Paper
Papier

Base de corte
Cutting Mat
Base de découpe

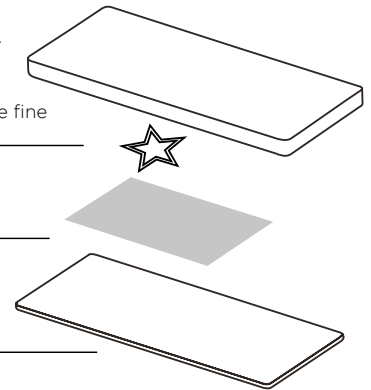

41009

Alfombrilla para repujar
Silicone Rubber Pad
Petit tapis pour gaufrer
15,3x21,6x0,2cm.

Base de corte
Cutting Mat
Base de découpe

Alfombrilla para repujar
Silicone Rubber Pad
Petit tapis pour gaufrer

Papel
Paper
Papier

Troquel
Die
Matrice de découpe

Plataforma
Platform
Plate-forme

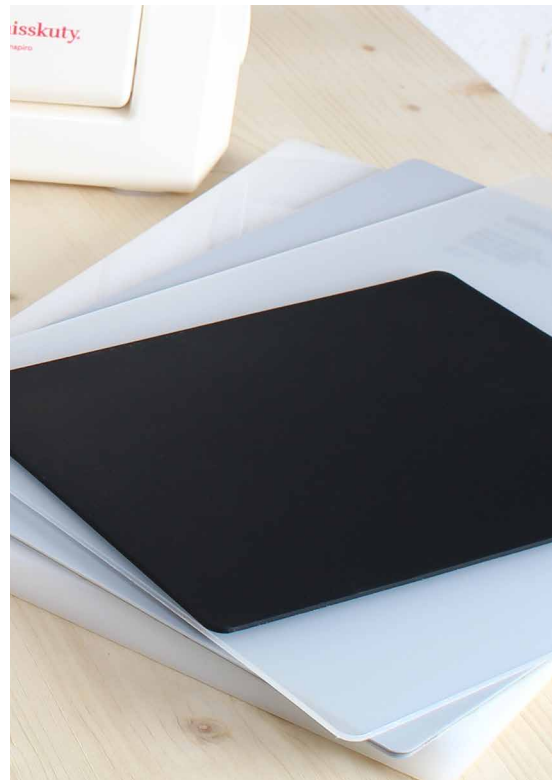
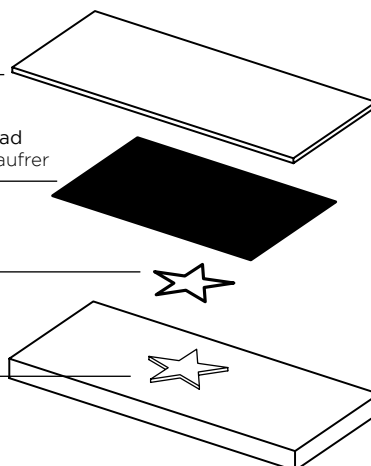



Las carpetas de repujado PUSH permiten crear textura sobre un simple papel, cartulina, goma eva u hoja de aluminio, convirtiendo cualquier proyecto en una pequeña obra de arte. ¡Resaltar tus trabajos nunca había sido tan fácil!

*Compatibles con las máquinas para troquelar y repujar MISSKUTY y otras marcas.

With PUSH Embossing Folders you can create texture effects on ordinary paper, cardstock, Eva foam or aluminium sheets, and turn any project into a small masterpiece. Highlighting your works has never been so easy!

*Compatible with MISSKUTY Cutting & Embossing Machines and die cutting machines from other brands.

Les dossiers de gaufrage PUSH permettent de pouvoir créer une texture sur un simple papier, bristol, mousse eva ou feuille d'aluminium, transformant tout projet en une petite œuvre d'art. Mettre en valeur vos résultats de travail n'aura jamais été si facile !

*Compatibles avec les machines pour découper et gaufrer MISSKUTY et autres marques.

Push

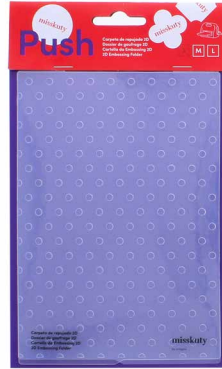

Carpeta de repujado
Embossing folder
Dossier de gaufrage

2
12,7x17,8cm.

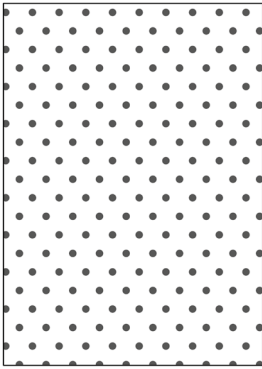

41016

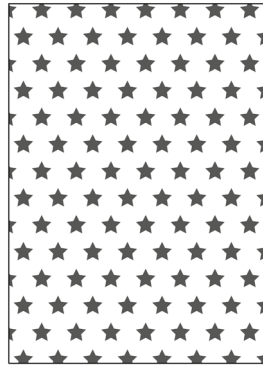

41017

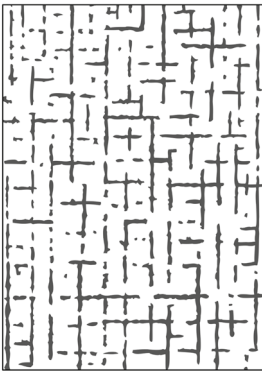

41018

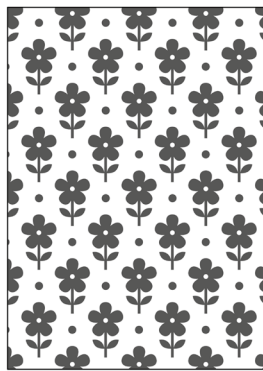

41019

Base de corte
Cutting Mat
Base de découpe

Carpeta de repujado
Embossing folder
Dossier de gaufrage

Papel
Paper
Papier

Plataforma
Platform
Plate-forme

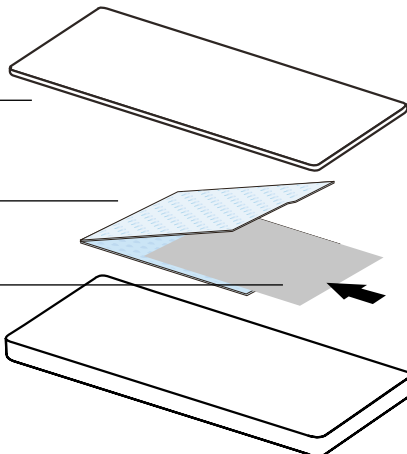

misskuty[®]

by innspiro

FONTORPIN, S.L.
C. Taga, 16. Ctra C17, km 73,5
08508 Les Masies de Voltregà
Barcelona (Spain)

T. (+34) 859 08 30

info@innspiro.com
www.innspiro.com

INN-2203

